

SAMSUNG

SERIES **6**
6300

LED TV

user manual

Thank you for purchasing this Samsung product.
To receive more complete service, please register
your product at
www.samsung.com/register

Model _____ Serial No. _____

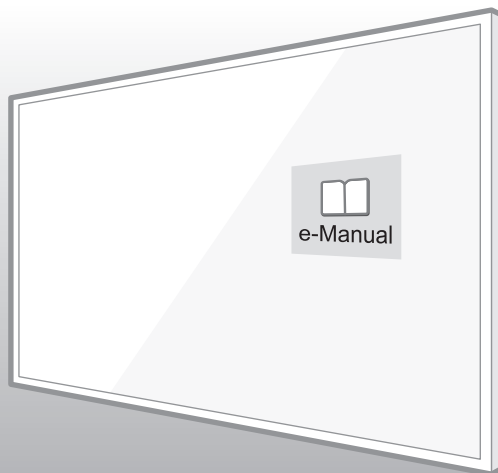



If you have any questions, please call us at 1-800-SAMSUNG (1-800-726-7864) for assistance.

* This Nanum Gothic Eco font is provided by NAVER.

Warning! Important Safety Instructions

Please read the Safety Instructions before using your TV.

CAUTION
RISK OF ELECTRIC SHOCK. DO NOT OPEN.
CAUTION: TO REDUCE THE RISK OF ELECTRIC SHOCK, DO NOT REMOVE COVER (OR BACK). THERE ARE NO USER SERVICEABLE PARTS INSIDE. REFER ALL SERVICING TO QUALIFIED PERSONNEL.

	This symbol indicates that high voltage is present inside. It is dangerous to make any kind of contact with any internal part of this product.
	This symbol indicates that this product has included important literature concerning operation and maintenance.

- The slots and openings in the cabinet and in the back or bottom are provided for necessary ventilation. To ensure reliable operation of this apparatus and to protect it from overheating, these slots and openings must never be blocked or covered.
 - ☑ Do not place this apparatus in a confined space, such as a bookcase or built-in cabinet, unless proper ventilation is provided.
 - ☑ Do not place this apparatus near or over a radiator or heat register, or where it is exposed to direct sunlight.
 - ☑ Do not place vessels (vases etc.) containing water on this apparatus, as this can result in a fire or electric shock.
- Do not expose this apparatus to rain or place it near water (near a bathtub, washbowl, kitchen sink, or laundry tub, in a wet basement, or near a swimming pool etc.). If this apparatus accidentally gets wet, unplug it and contact an authorized dealer immediately.
- This apparatus uses batteries. In your community, there might be environmental regulations that require you to dispose of these batteries properly. Please contact your local authorities for disposal or recycling information.
- Do not overload wall outlets, extension cords or adaptors beyond their capacity, since this can result in fire or electric shock.
- Power-supply cords should be placed so that they are not likely to be walked on or pinched by items placed upon or against them. Pay particular attention to cords at the plug end, at wall outlets, and at the point where they exit from the appliance.
- To protect this apparatus from a lightning storm, or when left unattended and unused for long periods of time, unplug it from the wall outlet and disconnect the antenna or cable system. This will prevent damage to the set due to lightning and power line surges.
 - Before connecting the AC power cord to the DC adaptor outlet, make sure that the voltage designation of the DC adaptor corresponds to the local electrical supply.
 - Never insert anything metallic into the open parts of this apparatus. This may cause a danger of electric shock.
 - To avoid electric shock, never touch the inside of this apparatus. Only a qualified technician should open this apparatus.
 - Be sure to plug in the power cord until it is firmly seated. When unplugging the power cord from a wall outlet, always pull on the power cord's plug. Never unplug it by pulling on the power cord. Do not touch the power cord with wet hands.
 - If this apparatus does not operate normally - in particular, if there are any unusual sounds or smells coming from it - unplug it immediately and contact an authorized dealer or service center.
 - Be sure to pull the power plug out of the outlet if the TV is to remain unused or if you are to leave the house for an extended period of time (especially when children, elderly or disabled people will be left alone in the house).
 - ☑ Accumulated dust can cause an electric shock, an electric leakage, or a fire by causing the power cord to generate sparks and heat or by causing the insulation to deteriorate.
 - Be sure to contact an authorized service center for information if you intend to install your TV in a location with heavy dust, high or low temperatures, high humidity, chemical substances, or where it will operate 24 hours a day such as in an airport, a train station, etc. Failure to do so may lead to serious damage to your TV.
 - Use only a properly grounded plug and wall outlet.
 - ☑ An improper ground may cause electric shock or equipment damage. (Class I Equipment only.)

- To turn off this apparatus completely, disconnect it from the wall outlet. To ensure you can unplug this apparatus quickly if necessary, make sure that the wall outlet and power plug are readily accessible.
- Do not allow children to hang onto the product.
- Store the accessories (battery, etc.) in a location safely out of the reach of children.
- Do not install the product in an unstable location such as a shaky shelf or a slanted floor or in a location exposed to vibration.
- Do not drop or strike the product. If the product is damaged, disconnect the power cord and contact a service center.
- To clean this apparatus, unplug the power cord from the wall outlet and wipe the product with a soft, dry cloth. Do not use any chemicals such as wax, benzene, alcohol, thinners, insecticide, air fresheners, lubricants, or detergents. These chemicals can damage the appearance of the TV or erase the printing on the product.
- Do not expose this apparatus to dripping or splashing.

- Do not dispose of batteries in a fire.
- Do not short-circuit, disassemble, or overheat the batteries.
- There is danger of an explosion if you replace the batteries used in the remote with the wrong type of battery. Replace only with the same or equivalent type.
- **WARNING - TO PREVENT THE SPREAD OF FIRE, KEEP CANDLES OR OTHER ITEMS WITH OPEN FLAMES AWAY FROM THIS PRODUCT AT ALL TIMES.**
- This product contains chemicals known to the State of California to cause cancer and reproductive toxicity.
- Use care when touching the TV after it has been on for some time. Some parts can be warm to the touch.



Internet security

Samsung takes a number of steps to protect its Internet-compatible Smart TVs against unauthorized incursions and hacking. For example, certain sensitive communications between the TV and the Internet servers are encrypted. In addition, the TV's operating system has adopted controls to prevent the installation of unauthorized applications.

Although we take steps to protect your Smart TV and personal information, no Internet-connected device or transmission is completely secure. We therefore encourage you to take additional steps to safeguard your TV, secure your Internet connection, and minimize the risk of unauthorized access. These steps are listed below:

- When Samsung releases software updates to improve the security of your TV, you should promptly install these updates. To automatically receive these updates, turn on **Auto Update** in the TV's menu (**Support > Software Update > Auto Update**). When an update is available, a popup message appears on the TV screen. Accept the software download and update by selecting YES when prompted. Take steps to secure your wireless router and network. Your router's manual should provide additional details about how to implement the following measures:
 - Secure your wireless router's management settings with a unique password to prevent unauthorized changes to security related settings.
 - Implement standard encryption (e.g., WPA2 encryption) on your wireless router to secure your wireless network signal.
 - Secure access to your wireless network with a hard-to-guess password.
 - Confirm your router's firewall setting is enabled (if so equipped).
 - Make sure that all your internet-connected devices are behind your network's firewall.
 - If your router or modem has a standby mode button, use it to disconnect your home network from the Internet when it is not in use.
- Use strong passwords for all your Internet accounts (Netflix, Facebook, Skype, etc.). If your TV has a camera, recess the camera into the TV's bezel when it is not in use. Recessing the camera makes it inoperative.
- If any unexpected messages appear on your TV screen requesting permission to link a device or enable a remote session, do NOT accept.
- Do not visit suspicious web sites and do not install any suspicious programs. We recommend that users install only those authorized apps provided by Samsung through Samsung Smart Hub.

Figures and illustrations in this User Manual are provided for reference only and may differ from the actual product appearance. Product design and specifications may change without notice.

Features of Your New TV

Smart Hub

Your TV features Smart Hub, a multi-purpose entertainment and family center. You can use Smart Hub to surf the web or download and run applications. In addition, you can view or play photo, video, and music files stored on external storage devices.

☑ Refer to the e-Manual for details.

e-Manual

Get help from a detailed, on-screen user's manual built into your TV.

Contents

1. Initial Setup

2. The Remote Control

3. Smart Hub

4. The e-Manual

5. Troubleshooting and Maintenance

- 8 Troubleshooting
- 9 Getting remote support for your TV
- 10 Network troubleshooting
- 12 Eco Sensor and screen brightness
- 12 Still image warning
- 12 Caring for the TV

6. Specifications and Other Information

- 13 Specifications
- 16 Licenses

7. TV Installation

- 17 Mounting the TV on a wall
- 18 Providing proper ventilation for your TV
- 19 Safety Precaution: Securing the TV to the wall to prevent falling
- 19 Arranging the cables with the cable guide

FCC and Warranty Information

1. Initial Setup

When you turn on your TV for the first time, it immediately starts the Initial Setup. During Initial Setup, your TV connects to your home network, implements Smart Hub agreements, links to the source of your live TV signal, and sets up control of your cable or satellite box.

Information You Need

Have the following information on hand before you turn on your TV for the first time:

- Your wireless network's password. (Make sure your network is on.)
- Your Postal or Zip code.
- The name and location of your cable or satellite provider (if you use one).

Internet Access

The TV must be connected to the Internet to use the Smart Features. If you have a wireless network, confirm that your network router is working before you start the initial setup. If you have a wired network, connect the TV's LAN port to the network with an Ethernet cable before you begin (CAT 7 cable preferred).

Running Initial Setup

1. Point the remote control at the TV.
2. Press the  button on the remote control to turn on the TV, and then follow the directions on the screen.

For more information about using the remote control, see "The Remote Control" on page 6.

To learn more about operating your TV and its Smart Features, launch the TV's built in e-Manual after you have completed the Initial Setup. For information about the e-Manual, see "The e-Manual" on page 7.

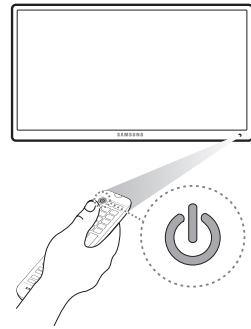

Using the TV Controller

You can use the TV Controller on the back of the TV instead of the remote control to control most of the functions of your TV. While watching TV or cable TV, you can change the channel or adjust the volume by pressing the Control Stick. When using Smart Hub, the TV's menu, or selecting a source, move the Control Stick up, down, left, or right to move the cursor. Press the Control Stick to select or activate the item highlighted by the cursor.

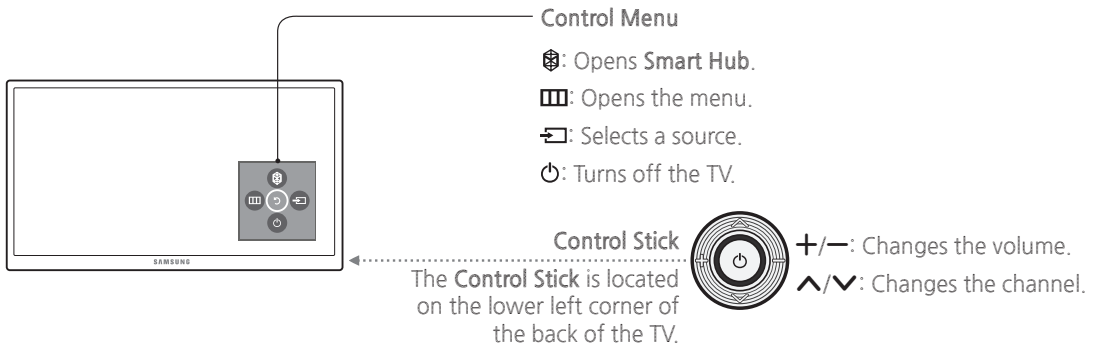

Using the SOURCE button to switch between video sources

Press the **SOURCE** button to switch between external devices connected to the TV. For example, to switch to a game console connected to the second HDMI connector, press the **SOURCE** button. The **Source** list appears across the top of the screen. From the **Source** list, select **HDMI2**.

 The connector names may differ with the product chosen.

2. The Remote Control

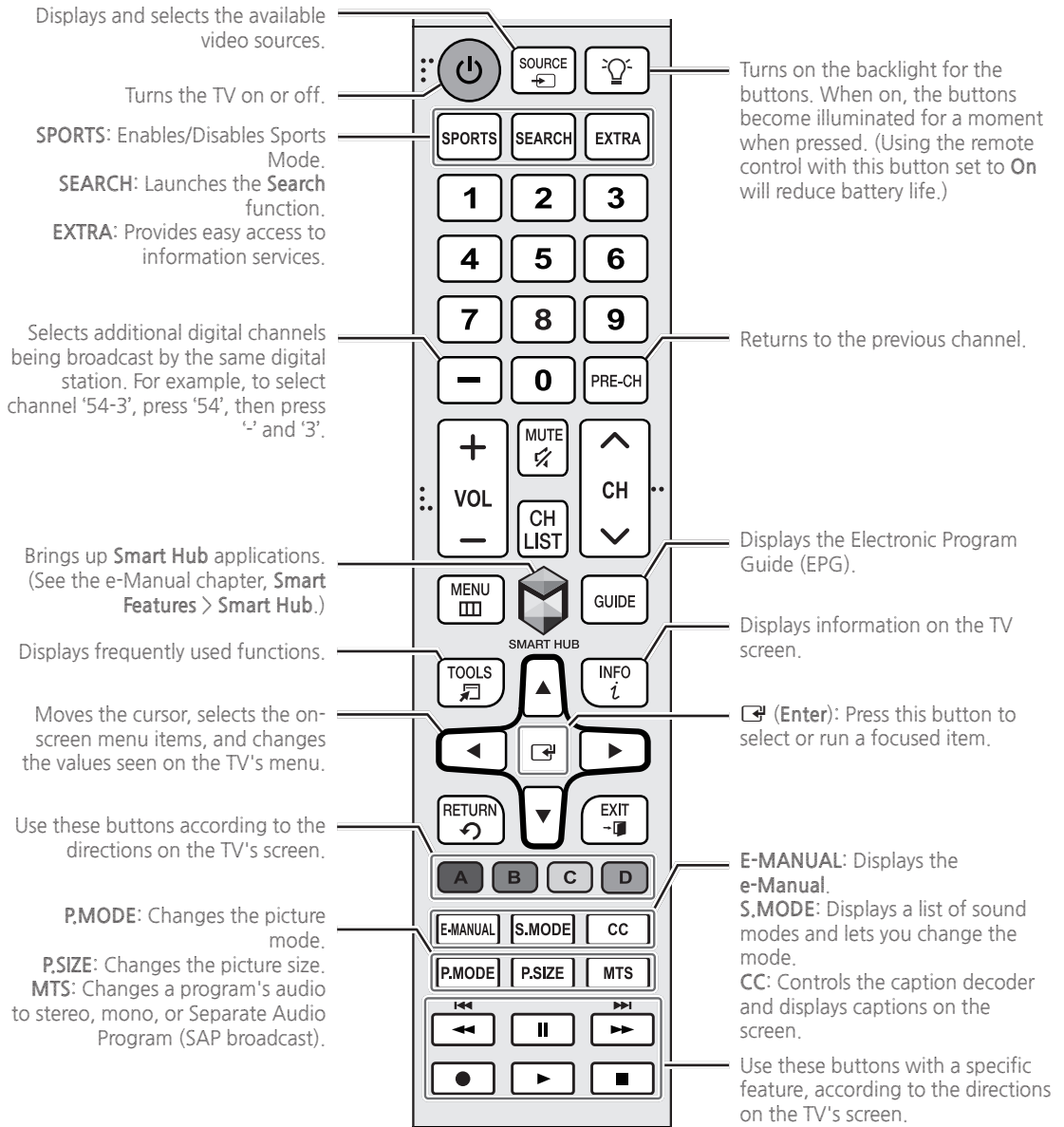

The button names above may differ from the actual names.

Installing batteries into the remote control

Match the polarity of the batteries to the symbols in the battery compartment.

- Use the remote control within 23 feet of the TV.
- Bright light may affect the performance of the remote control. Avoid using near bright fluorescent lights or neon signs.
- The color and shape of the remote may vary depending on the model.

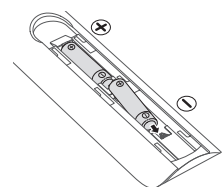

3. Smart Hub

Smart Hub is the control center of your TV and its most important feature. You can use Smart Hub to surf the web, download and play apps, and playback photo, video, and music files stored on Blue-ray players, USB devices, smart phones, personal tablets, computers, and the Internet.

To open Smart Hub, press the  button on the remote control. Smart Hub services are divided into two groups, **Recent** (recently used) and **Featured**, at the bottom of the screen. The currently active group, with individually displayed icons, is on the right. The currently inactive group is on the left. To access the services in the inactive group, select that group, and then press the Enter button.

To launch a service, select its icon and then press the Enter button. You can only select and launch services from the active group.

For more information about Smart Hub, see the e-Manual.

 You must have the TV connected to the Internet to access Smart Hub.

4. The e-Manual

The embedded e-Manual contains information about the key features of your TV.

 You can download and view a printable version of the e-Manual on the Samsung website.

Displaying the e-Manual:

- On the remote control, press the **E-MANUAL** button.
- In the TV's menu, select **Support > e-Manual**.

Using the buttons available on the main screen of the e-Manual

 (**Search**): Select an item from the search results to load the corresponding page.

 (**Index**): Select a keyword to navigate to the relevant page.

 (**Recently Viewed Topics**): Select a topic from the list of recently viewed topics.

Accessing the associated menu screen from an e-Manual topic page

 (**Try Now**): Access the associated menu item and try out the feature directly.

 (**Link**): Access a topic referred to on an e-Manual topic page.

Accessing the associated e-Manual topic from a menu screen

Press the **E-MANUAL** button on the remote control to read the e-Manual topic about a current screen menu function.

 The e-Manual cannot be accessed from some menu screens.

Updating the e-Manual to the latest version

You can update the e-Manual in the same way you update apps.

5. Troubleshooting and Maintenance

Troubleshooting

If the TV seems to have a problem, first review this list of possible problems and solutions. Alternatively, review the Troubleshooting Section in the e-Manual. If none of the troubleshooting tips apply, visit www.samsung.com/support or call Samsung Customer Service at 1-800-SAMSUNG (1-800-726-7864).

- ☑ For detailed information on troubleshooting, watch the troubleshooting videos at www.samsung.com/spsn.
- ☑ This TFT LED panel is made up of sub pixels which require sophisticated technology to produce. There may be, however, a few bright or dark pixels on the screen. These pixels will have no impact on the performance of the product.
- ☑ To keep your TV in optimum condition, upgrade to the latest software. Use the Update Now or Auto Update functions on the TV's menu (**MENU > Support > Software Update > Update now or Auto Update**).

The TV won't turn on.

- Make sure that the AC power cord is securely plugged in to the TV and the wall outlet.
- Make sure that the wall outlet is working.
- Confirm that the batteries in the remote are good. If not, replace them.
- Try pressing the Power button on the TV to make sure that the problem is not with the remote control. If the TV turns on, refer to "Remote control does not work" below.
- If the TV is connected to an antenna, check the antenna connections.
- If the TV is connected to a cable/satellite box, make sure that the cable/satellite box is turned on.

There is no picture/video/sound or distorted picture/video/sound from an external device.

- Make sure the connection to the device is correct and that all cables are fully inserted. Remove and reconnect all cables connected to the TV and external devices.
- Set the video outputs of your external devices (cable/satellite box, DVD, Blu-ray etc) to match the TV's input connections. For example, if an external device's output is HDMI, connect it to an HDMI input on the TV.
- Make sure that your connected devices are powered on.
- Press the **SOURCE** button on your remote and confirm that the correct input source has been selected.
- Reboot the connected devices by unplugging each device's power cord and then plugging them in again.
- Perform a TV self diagnosis to determine if the problem is caused by the TV or the device. (**MENU > Support > Self Diagnosis > Sound Test or Picture Test**).
- Change the picture size (**MENU > Picture > Picture Size > Picture Size**).
- Make sure that the correct speaker output is selected (**MENU > Sound > Speaker Settings > Speaker Select**).

The remote control does not work.

- Replace the remote control batteries. Make sure that the batteries are installed with their poles (+/-) in the correct direction.
- Clean the sensor's transmission window on the remote.
- Try pointing the remote directly at the TV from 5~6 feet away.

The cable or satellite box remote control doesn't turn the TV on or off or adjust the volume.

- Program the cable or satellite box remote control to operate the TV. Refer to the cable or satellite box user manual for the SAMSUNG TV code.

The TV cannot connect to your network or apps (for Internet compatible models only).

- Make sure the TV has a network connection (**MENU > Network > Network Status**).
- Contact your Internet service provider.

The picture quality is low.

- Select high definition (HD) channels or programs.

The TV settings are lost after 5 minutes.

- Change to **Home Use** mode. (**MENU > Support > Use Mode > Home Use**).

“Weak or No Signal” displayed in TV mode/cannot find channel.

- Press the **SOURCE** button on your remote and confirm that the correct input source has been selected.
- If the TV is not connected to a cable or satellite box, run **Auto Program** to search for channels (**MENU > Broadcasting > Auto Program**).

The stand is wobbly or crooked.

- Make sure the indicator arrows on the stand and stand holder are properly aligned.

The remote control, gestures, and/or voice does not work.

- The TV ships with protective stickers covering some of the sensors. Make sure all of the stickers have been removed.

Getting remote support for your TV

Samsung Remote Support service offers you one-on-one support with a Samsung Technician who can remotely:

- Diagnose your TV
- Adjust the TV settings for you
- Perform a factory reset on your TV
- Install recommended firmware updates

How does remote support work?

You can easily have a Samsung Tech service your TV remotely:

1. Call the Samsung Contact Center and ask for remote support.
2. Open the menu on your TV and go to the **Support** section.
3. Select **Remote Management**, then read and agree to the service agreements. When the PIN screen appears, provide the PIN number to the agent.
4. The agent will then access your TV. That's it!

Network troubleshooting

Improving your wireless signal

Position your wireless router, modem router, or access point in a central location. Avoid putting it in a corner.

Single story



Unsuitable router position



Recommended router position

Multi story



Unsuitable router position

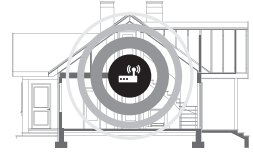

Recommended router position

Adding a wireless repeater



Use a wireless repeater to get an instant boost in your wireless signal strength. Place the repeater halfway between your wireless router and your TV.

Single story



Multi story



-  Wireless router
-  Wireless repeater

Reducing wireless interference

The most common wireless technology, 802.11g (wireless-G), operates at a frequency of 2.4 GHz. This frequency is widely used by many cordless phones, microwave ovens, baby monitors, garage doors, and other wireless devices. Reduce interference by avoiding wireless devices that use the 2.4 GHz frequency. Instead, use devices that communicate via the 5.0 GHz frequency.

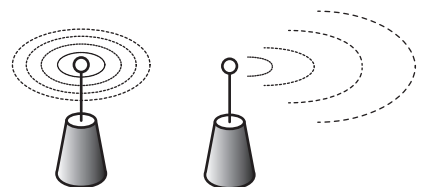

Intermittent Wi-Fi

- Check the distance between the TV and the Modem/Router. The distance should not exceed 50ft (15.2 m).
- Verify that there are no obstacles between the TV and the Modem/Router. (The Wi-Fi strength can be decreased by appliances, cordless phones, stone walls/fireplaces, etc.)
- Check the cable that connects the Modem to the Router (if you use a separate Modem and Router) to see if it is in good condition. If it is not, replace the cable.
- Connect the TV to your Modem/Router using a CAT 7 cable and try to set up a wired network connection. (**MENU > Network > Network Settings**).
- Check **Network Status (MENU > Network > Network Status)** to see if the IP address is invalid, for example, 169.x.x.x. If it is, call your ISP to get a valid IP address, and then ask them to check the connection not only between your Modem and Router but also between the Modem / Router and the Internet.
- If you see a valid Mac address, call your ISP and ask them to reset your network circuit to re-register the Mac addresses of your new Modem/Router and the TV.

Netflix problems

- Change the DNS to 8.8.8.8. Select **MENU > Network > Network Status > IP Settings > DNS setting > Enter manually > DNS Server > enter 8.8.8.8 > OK**
- Verify that the ESN for Netflix is valid. (Go to **MENU > Support > Contact Samsung**)
Reset Netflix by selecting **MENU > Smart Hub > Reset Smart Hub**.

Smart Hub error messages

- Reset Smart Hub by selecting **MENU > Smart Hub > Reset Smart Hub**.
- Update the TV's software (**MENU > Support > Software Update**).

Eco Sensor and screen brightness

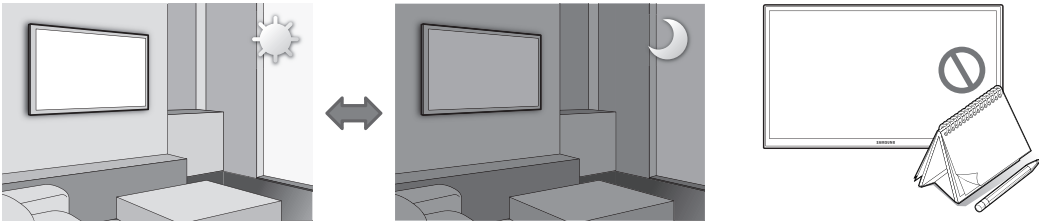

Eco Sensor adjusts the brightness of the TV automatically. This feature measures the light in your room and optimizes the brightness of the TV automatically to reduce power consumption. If you want to turn this off, go to **MENU > System > Eco Solution > Eco Sensor**.

- ☑ If the screen is too dark while you are watching TV in a dark environment, it may be due to the **Eco Sensor**.
- ☑ Do not block the sensor with any object. This can decrease picture brightness.

Still image warning

Avoid displaying still images (such as jpeg picture files), still image elements (such as TV channel logos, stock or news crawls at the screen bottom etc.), or programs in panorama or 4:3 image format on the screen. If you constantly display still pictures, it can cause image burn-in on the LED screen and affect image quality. To reduce the risk of this adverse effect, please follow the recommendations below:

- Avoid displaying the same TV channel for long periods.
- Always try to display any image in full screen. Use the picture format menu of the TV set for the best possible match.
- Reduce brightness and contrast to avoid the appearance of after-images.
- Use all TV features designed to reduce image retention and screen burn. Refer to the e-Manual for details.

Caring for the TV

- ☑ If a sticker was attached to the TV screen, some debris can remain after you remove the sticker. Please clean the debris off before watching TV.
- ☑ The exterior and screen of the TV can get scratched during cleaning. Be sure to wipe the exterior and screen carefully using a soft cloth to prevent scratches.

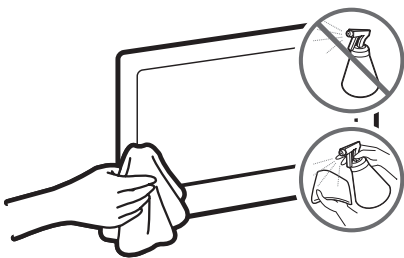

Do not spray water or any liquid directly onto the TV. Any liquid that goes into the product may cause a failure, fire, or electric shock.

Turn off the TV, then gently wipe away smudges and fingerprints on the screen with a micro-fiber cloth. Clean the body of the TV with a soft cloth dampened with a small amount of water. Do not use flammable liquids (benzene, thinners, etc.) or a cleaning agent. For stubborn smudges, spray a small amount of screen cleaner on the cloth, and then use the cloth to wipe away the smudges.

6. Specifications and Other Information

Specifications

Display Resolution	1920 x 1080	
Environmental Considerations		
Operating Temperature	50°F to 104°F (10°C to 40°C)	
Operating Humidity	10% to 80%, non-condensing	
Storage Temperature	-4°F to 113°F (-20°C to 45°C)	
Storage Humidity	5% to 95%, non-condensing	
Sound (Output)	20W	
Model Name	UN32J6300	UN40J6300
Screen Size (Diagonal)	32" Class (31.5 measured diagonally)	40" Class (40.0 measured diagonally)
Dimensions (W x H x D)		
Body	28.4 x 16.5 x 2.4 inches (722.1 x 420.6 x 62.9 mm)	35.7 x 20.7 x 2.4 inches (907.2 x 525.7 x 63.1 mm)
With stand	28.4 x 18.6 x 8.1 inches (722.1 x 473.4 x 207.6 mm)	35.7 x 23.0 x 11.3 inches (907.2 x 585.6 x 288.1 mm)
Weight		
Without Stand	11.2 lbs (5.1 Kg)	17.1 lbs (7.8 Kg)
With Stand	12.1 lbs (5.5 Kg)	19.1 lbs (8.7 Kg)
Model Name	UN48J6300	UN50J6300
Screen Size (Diagonal)	48" Class (47.6 measured diagonally)	50" Class (49.5 measured diagonally)
Dimensions (W x H x D)		
Body	42.3 x 24.4 x 2.5 inches (1075.8 x 620.4 x 63.5 mm)	43.9 x 25.3 x 2.5 inches (1116.8 x 642.9 x 63.7 mm)
With stand	42.3 x 26.8 x 12.2 inches (1075.8 x 681.7 x 310.5 mm)	43.9 x 27.7 x 12.2 inches (1116.8 x 703.6 x 310.5 mm)
Weight		
Without Stand	24.9 lbs (11.3 Kg)	28.2 lbs (12.8 Kg)
With Stand	27.1 lbs (12.3 Kg)	30.4 lbs (13.8 Kg)

Model Name	UN55J6300	UN60J6300
Screen Size (Diagonal)	55" Class (54.6 measured diagonally)	60" Class (60 measured diagonally)
Dimensions (W x H x D) Body	48.4 x 27.8 x 2.5 inches (1230.6 x 707.4 x 64.0 mm)	53.7 x 30.9 x 2.5 inches (1365.0 x 786.4 x 64.4 mm)
With stand	48.4 x 30.3 x 12.2 inches (1230.6 x 770.6 x 310.5 mm)	53.7 x 33.8 x 14.5 inches (1365.0 x 859.8 x 369.4 mm)
Weight Without Stand	34.6 lbs (15.7 Kg)	51.8 lbs (23.5 Kg)
With Stand	36.8 lbs (16.7 Kg)	56.4 lbs (25.6 Kg)
Model Name	UN65J6300	UN65J630D
Screen Size (Diagonal)	65" Class (64.5 measured diagonally)	65" Class (64.5 measured diagonally)
Dimensions (W x H x D) Body	57.2 x 32.8 x 2.8 inches (1454.5 x 835.4 x 70.9 mm)	57.2 x 32.8 x 2.7 inches (1454.5 x 835.4 x 70.9 mm)
With stand	57.2 x 35.8 x 14.5 inches (1454.5 x 910.2 x 369.4 mm)	57.2 x 35.8 x 14.5 inches (1454.5 x 910.2 x 369.4 mm)
Weight Without Stand	56.2 lbs (25.5 Kg)	56.2 lbs (25.5 Kg)
With Stand	60.8 lbs (27.6 Kg)	60.8 lbs (27.6 Kg)
Model Name	UN75J6300	UN75J630D
Screen Size (Diagonal)	75" Class (74.5 measured diagonally)	75" Class (74.5 measured diagonally)
Dimensions (W x H x D) Body	66.0 x 37.7 x 2.8 inches (1676.2 x 959.6 x 70.9 mm)	65.9 x 37.7 x 2.7 inches (1676.2 x 959.6 x 70.9 mm)
With stand	66.0 x 41.1 x 12.5 inches (1676.2 x 1045.6 x 318.4 mm)	65.9 x 41.1 x 12.5 inches (1676.2 x 1045.6 x 318.4 mm)
Weight Without Stand	68.7 lbs (31.2 Kg)	68.7 lbs (31.2 Kg)
With Stand	70.5 lbs (32.0 Kg)	70.5 lbs (32.0 Kg)

Notes

- Design and specifications are subject to change without prior notice.
- The actual appearance of the TV may differ from the images in this manual, depending on the model.
- This device is a Class B digital apparatus.
- For information about the power supply, and more information about power consumption, refer to the label attached to the product.
- Typical power consumption is measured according to Energy Star Program requirements for televisions.
- Your TV and its accessories may look different than the product images presented in this manual, depending on the model.
- All drawings are not necessarily to scale. Some dimensions are subject to change without prior notice. Refer to the dimensions before installing your TV. Not responsible for typographical or printed errors.

© 2015 Samsung Electronics America, Inc

Dispose unwanted electronics through an approved recycler.

To find the nearest recycling location, go to our website:

www.samsung.com/recyclingdirect or call, (877) 278 - 0799

Decreasing power consumption

When you shut the TV off, it enters Standby mode. In Standby mode, it continues to draw a small amount of power. To decrease power consumption, unplug the power cord when you don't intend to use the TV for a long time.

Dimensions

Port panel detail / Rear view

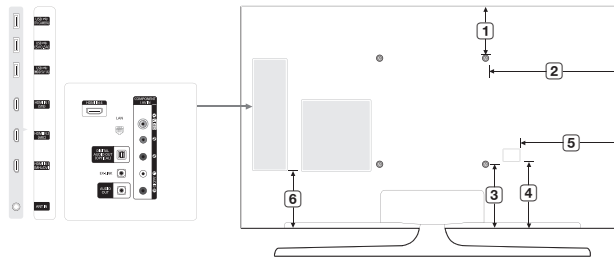

The displayed image may differ from your TV, depending on the model.

(Unit: inches)

Model name	①	②	③	④	⑤	⑥
UN32J6300	3.7	10.2	4.8	5.0	7.7	4.3
UN40J6300	4.8	13.8	7.8	7.1	10.4	7.7
UN48J6300	2.9	13.2	8.7	9.5	11.0	8.8
UN50J6300	3.4	14.0	6.0	9.5	11.6	8.1
UN55J6300	5.9	16.3	6.1	9.5	13.4	9.3
UN60J6300	7.5	34.7	7.6	9.1	14.0	9.2
UN65J6300 / UN65J630D	9.5	20.7	7.5	9.0	15.7	9.3
UN75J6300	10.8	25.1	11.1	10.7	21.7	13.3
UN75J630D	10.8	25.1	11.0	10.7	21.7	13.3

Licenses



HDMI

The terms HDMI and HDMI High-Definition Multimedia Interface, and the HDMI Logo are trademarks or registered trademarks of HDMI Licensing LLC in the United States and other countries.

7. TV Installation

Mounting the TV on a wall



If you mount this TV on a wall, follow the instructions exactly as set out by the manufacturer. Unless it is correctly mounted, the TV may slide or fall and cause serious injury to a child or adult and serious damage to the TV.

Installing the wall mount kit

You can mount the TV on the wall using a wall mount kit (sold separately). For models providing wall mount adapters, install them as shown in the figure below before installing the wall mount kit.

Refer to the installation manual included with the Samsung wall mount kit.

32 ~ 60 Inch

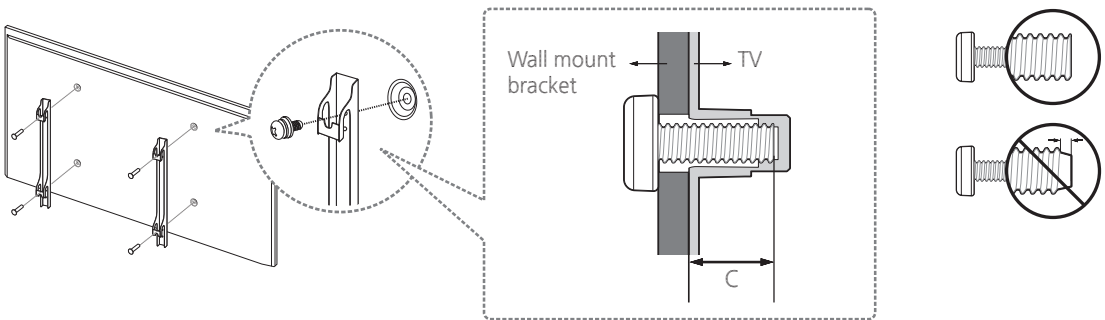

65 ~ 75 Inch

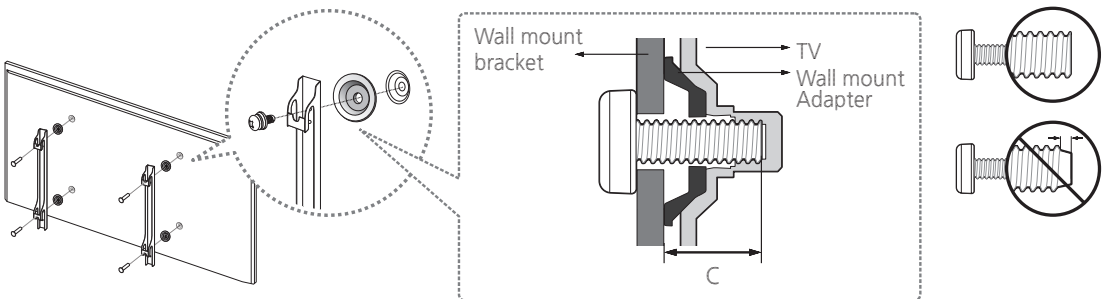

For detailed information about installing the wall mount, see the instructions provided with the wall mount kit. We recommend that you contact a technician for assistance when installing the wall mount bracket. We do not advise you to do it yourself. Samsung Electronics is not responsible for any damage to the product or injury to yourself or others if you choose to install the wall mount on your own.

To order the wall mount kit, contact Samsung Customer Care at 1-800-SAMSUNG (1-800-726-7864).

VESA wall mount kit notes and specifications

You can install your wall mount on a solid wall perpendicular to the floor. Before attaching the wall mount to surfaces other than plaster board, contact your nearest dealer for additional information. If you install the TV on a ceiling or slanted wall, it may fall and result in severe personal injury.

Standard dimensions for wall mount kits are shown in the table below.

If you are installing a third-party wall mount, note that the length of the screws you can use to attach the TV to the wall mount is shown in column C in the table below.

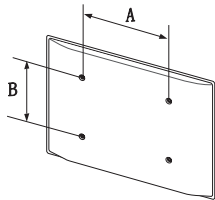
Product Family	TV size in inches	VESA screw hole specs (A * B) in millimeters	C (mm)	Standard Screw	Quantity	
LED-TV	32	200 x 200	19.8 ~ 20.8	M8	4	
	40		20.0 ~ 21.0			
	48	400 X 400	20.7 ~ 21.7			
	50		20.6 ~ 21.6			
	55		20.3 ~ 21.3			
	60		21.0 ~ 22.0			
	65		21.0 ~ 22.0			
	75		21.0 ~ 22.0			



Do not install your wall mount kit while your TV is turned on. This may result in personal injury from electric shock.

- Do not use screws that are longer than the standard dimension or do not comply with the VESA standard screw specifications. Screws that are too long may cause damage to the inside of the TV set.
- For wall mounts that do not comply with the VESA standard screw specifications, the length of the screws may differ depending on the wall mount specifications.
- Do not fasten the screws too firmly. This may damage the product or cause the product to fall, leading to personal injury. Samsung is not liable for these kinds of accidents.
- Samsung is not liable for product damage or personal injury when a non-VESA or non-specified wall mount is used or the consumer fails to follow the product installation instructions.
- Do not mount the TV at more than a 15 degree tilt.
- Always have two people mount the TV onto a wall.

Providing proper ventilation for your TV

When you install your TV, maintain a distance of at least 4 inches between the TV and other objects (walls, cabinet sides, etc.) to ensure proper ventilation. Failing to maintain proper ventilation may result in a fire or a problem with the product caused by an increase in its internal temperature.

When you install your TV with a stand or a wall mount, we strongly recommend you use parts provided by Samsung Electronics only. Using parts provided by another manufacturer may cause difficulties with the product or result in injury caused by the product falling.

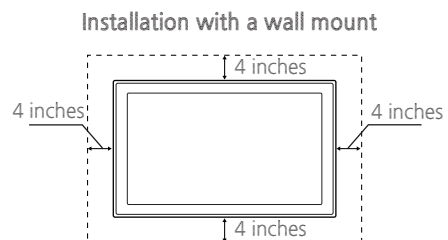
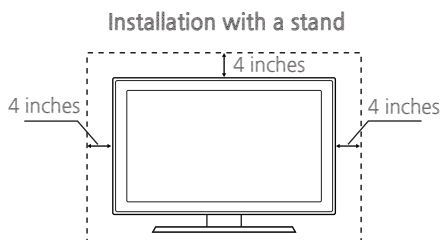

Safety Precaution: Securing the TV to the wall to prevent falling



Caution: Pulling, pushing, or climbing on the TV may cause the TV to fall. In particular, ensure your children do not hang on or destabilize the TV. This action may cause the TV to tip over, causing serious injuries or death. Follow all safety precautions provided in the Safety Flyer included with your TV. For added stability and safety, you can purchase and install the anti-fall device as described below.

Preventing the TV from falling

These are general instructions. The brackets, screws, and string are not supplied by Samsung. They must be purchased separately. We suggest consulting an installation service or professional TV installer for specific hardware and anti-fall hardware installation.

1. Put the screws into one set of brackets, and then firmly fasten them to the wall. Confirm that the screws are firmly attached to the wall.
 - ✎ You may need additional material such as wall anchors depending on the type of wall.
2. Remove the screws from the back center of the TV, put the screws into a second set of brackets, and then fasten the screws to the TV again.
 - ✎ These screws may not be supplied with the TV. For a 32-75 inch model, purchase M8 screws.
3. Connect the brackets fixed to the TV and the brackets fixed to the wall with a durable, heavy-duty string, and then tie the string tightly.
 - ✎ Install the TV near the wall so that it does not fall backwards.
 - ✎ Connect the string so that the brackets fixed to the wall are at the same height as or lower than the brackets fixed to the TV.
 - ✎ Untie the string before moving the TV.
4. Make sure that all connections are properly secured. Periodically check the connections for any sign of fatigue or failure. If you have any doubt about the security of your connections, contact a professional installer.

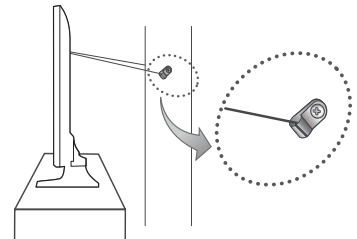
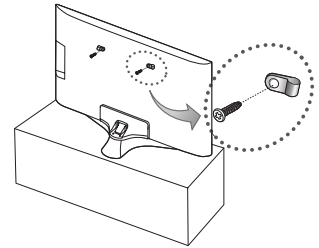

Arranging the cables with the cable guide

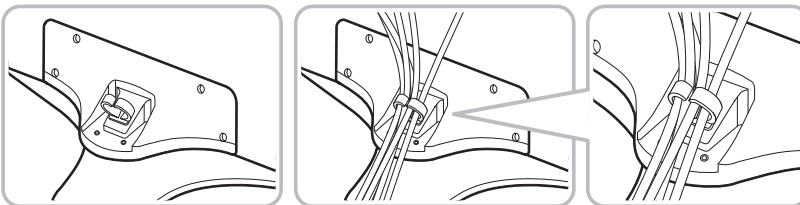

FCC and Warranty Information

Federal Communication Commission Interference Statement

This equipment has been tested and found to comply with the limits for a Class B digital device, pursuant to Part 15 of the FCC Rules. These limits are designed to provide reasonable protection against harmful interference in a residential installation. This equipment generates, uses and can radiate radio frequency energy and, if not installed and used in accordance with the instructions, may cause harmful interference to radio communications. However, there is no guarantee that interference will not occur in a particular installation. If this equipment does cause harmful interference to radio or television reception, which can be determined by turning the equipment off and on, the user is encouraged to try to correct the interference by one of the following measures:

- Reorient or relocate the receiving antenna.
- Increase the separation between the equipment and receiver.
- Connect the equipment into an outlet on a circuit different from that to which the receiver is connected.
- Consult the dealer or an experienced radio/TV technician for help.

FCC Caution: Any changes or modifications not expressly approved by the party responsible for compliance could void the user's authority to operate this equipment.

This device complies with Part 15 of the FCC Rules. Operation is subject to the following two conditions: (1) This device may not cause harmful interference, and (2) this device must accept any interference received, including interference that may cause undesired operation.

For product available in the USA/Canada market, only channel 1~11 can be operated. Selection of other channels is not possible.

This device and its antenna(s) must not be co-located or operation in conjunction with any other antenna or transmitter.

FCC Radiation Exposure Statement:

This equipment complies with FCC radiation exposure limits set forth for an uncontrolled environment. This equipment should be installed and operated with minimum distance 20cm between the radiator & your body.

IMPORTANT WARRANTY INFORMATION REGARDING TELEVISION FORMAT VIEWING

☑ See the warranty card for more information on warranty terms.

Wide screen format LED Displays (with 16:9 aspect ratios, the ratio of the screen width to height) are primarily designed to view wide screen format full-motion video. The images displayed on them should primarily be in the wide screen, 16:9 ratio format, or expanded to fill the screen, if your model offers this feature, with the images constantly in motion. Displaying stationary graphics and images on the screen, such as the dark sidebars on non-expanded standard format television video and programming, should be limited to no more than 5% of the total television viewing time per week.

Additionally, viewing other stationary images and text such as stock market crawls, video game displays, station logos, web sites or computer graphics and patterns, should be limited as described above for all televisions.

Displaying stationary images that exceed the above guidelines can cause uneven aging of LED Displays that leave subtle, but permanent burned-in ghost images in the LED picture. To avoid this, vary the programming and images, and primarily display full screen moving images, not stationary patterns or dark bars. On LED models that offer picture sizing features, use these controls to view different formats as a full screen picture.

Be careful about the television formats you select and the length of time you view them. Uneven LED aging as a result of format selection and use, as well as burned in images, are not covered by your Samsung limited warranty.

- SAMSUNG ELECTRONICS NORTH AMERICAN LIMITED WARRANTY STATEMENT

Subject to the requirements, conditions, exclusions and limitations of the original Limited Warranty supplied with Samsung Electronics (SAMSUNG) products, and the requirements, conditions, exclusions and limitations contained herein, SAMSUNG will additionally provide Warranty Repair Service in the United States on SAMSUNG products purchased in Canada, and in Canada on SAMSUNG products purchased in the United States, for the warranty period originally specified, and to the Original Purchaser only.

The above described warranty repairs must be performed by a SAMSUNG Authorized Service Center. Along with this Statement, the Original Limited Warranty Statement and a dated Bill of Sale as Proof of Purchase must be presented to the Service Center. Transportation to and from the Service Center of TVs 37" or smaller is the responsibility of the purchaser. Conditions covered are limited only to manufacturing defects in material or workmanship, and only those encountered in normal use of the product.

Exclusions include, but are not limited to, any originally specified provisions for in-home or on-site services, minimum or maximum repair times, exchanges or replacements, accessories, options, upgrades, or consumables.

For the location of a SAMSUNG Authorized Service Center, please call toll-free:

☎ In the United States: 1-800-SAMSUNG (1-800-726-7864)

☎ In Canada: 1-800-SAMSUNG

LIMITED WARRANTY TO ORIGINAL PURCHASER

This SAMSUNG brand product, as supplied and distributed by SAMSUNG and delivered new, in the original carton to the original consumer purchaser, is warranted by SAMSUNG against manufacturing defects in materials and workmanship for period of: (90 Days Parts and Labor for Commercial Use)

Categories	Parts	Labor	Size	Service
LCD/LED TV	1 Year	1 Year	42" and Larger *Includes 40" UHD Model	Carry-In or In Home
			40" and Smaller	Carry-In
Plasma Display	1 Year	1 Year	All	Carry-In or In Home
3D Glasses	1 Year	1 Year	-	Carry-In or Pick up

This limited warranty begins on the original date of purchase, and is valid only on products purchased and used in the United States. To receive warranty service, the purchaser must contact SAMSUNG for problem determination and service procedures.

Warranty service can only be performed by a SAMSUNG authorized service center. The original dated bill of sale must be presented upon request as proof of purchase to SAMSUNG or SAMSUNG's authorized service center.

SAMSUNG will repair or replace this product, at our option and at no charge as stipulated herein, with new or reconditioned parts or products if found to be defective during the limited warranty period specified above. All replaced parts and products become the property of SAMSUNG and must be returned to SAMSUNG. Replacement parts and products assume the remaining original warranty, or ninety (90) days, whichever is longer.

Certain products are eligible for In-home service at Samsung's discretion. To receive in-home service, the product must be unobstructed and accessible to service personnel. If during in-home service, repair cannot not be completed, it may be necessary to remove, repair and return the product. If in-home service is unavailable, SAMSUNG may elect, at our option, to provide for transportation of our choice to and from a SAMSUNG authorized service center. Otherwise, and for 37" and smaller LCD/LED TV, transportation to and from the SAMSUNG authorized service center is the responsibility of the purchaser.

This limited warranty covers manufacturing defects in materials and workmanship encountered in normal, and except to the extent otherwise expressly provided for in this statement, noncommercial use of this product, and shall not apply to the following, including, but not limited to: damage which occurs in shipment; delivery and installation; applications and uses for which this product was not intended; altered product or serial numbers; cosmetic damage or exterior finishes; accidents, abuse, neglect, fire, water, lightning or other acts of nature; use of products, equipment, systems, utilities, services, parts, supplies, accessories, applications, installations, repairs, external wiring or connectors not supplied or authorized by SAMSUNG which damage this product or result in service problems; incorrect electrical line voltage, fluctuations and surges; customer adjustments and failure to follow operating instructions, cleaning, maintenance and environmental instructions that are covered and prescribed in the instruction book; reception problems and distortion related to noise, echo, interference or other signal transmission and delivery problems; brightness related to normal aging, or burned-in images. SAMSUNG does not warrant uninterrupted or error-free operation of the product.

THERE ARE NO EXPRESS WARRANTIES OTHER THAN THOSE LISTED AND DESCRIBED ABOVE, AND NO WARRANTIES WHETHER EXPRESS OR IMPLIED, INCLUDING, BUT NOT LIMITED TO, ANY IMPLIED WARRANTIES OF MERCHANTABILITY OR FITNESS FOR A PARTICULAR PURPOSE, SHALL APPLY AFTER THE EXPRESS WARRANTY PERIODS STATED ABOVE, AND NO OTHER EXPRESS WARRANTY OR GUARANTY GIVEN BY ANY PERSON, FIRM OR CORPORATION WITH RESPECT TO THIS PRODUCT SHALL BE BINDING ON SAMSUNG. SAMSUNG SHALL NOT BE LIABLE FOR LOSS OF REVENUE OR PROFITS, FAILURE TO REALIZE SAVINGS OR OTHER BENEFITS, OR ANY OTHER SPECIAL, INCIDENTAL OR CONSEQUENTIAL DAMAGES CAUSED BY THE USE, MISUSE OR INABILITY TO USE THIS PRODUCT, REGARDLESS OF THE LEGAL THEORY ON WHICH THE CLAIM IS BASED, AND EVEN IF SAMSUNG HAS BEEN ADVISED OF THE POSSIBILITY OF SUCH DAMAGES. NOR SHALL RECOVERY OF ANY KIND AGAINST SAMSUNG BE GREATER IN AMOUNT THAN THE PURCHASE PRICE OF THE PRODUCT SOLD BY SAMSUNG AND CAUSING THE ALLEGED DAMAGE. WITHOUT LIMITING THE FOREGOING, PURCHASER ASSUMES ALL RISK AND LIABILITY FOR LOSS, DAMAGE OR INJURY TO PURCHASER AND PURCHASER'S PROPERTY AND TO OTHERS AND THEIR PROPERTY ARISING OUT OF THE USE, MISUSE OR INABILITY TO USE THIS PRODUCT SOLD BY SAMSUNG NOT CAUSED DIRECTLY BY THE NEGLIGENCE OF SAMSUNG. THIS LIMITED WARRANTY SHALL NOT EXTEND TO ANYONE OTHER THAN THE ORIGINAL PURCHASER OF THIS PRODUCT, IS NONTRANSFERABLE AND STATES YOUR EXCLUSIVE REMEDY.

Some states do not allow limitations on how long an implied warranty lasts, or the exclusion or limitation of incidental or consequential damages, so the above limitations or exclusions may not apply to you. This warranty gives you specific legal rights, and you may also have other rights which vary from state to state.

To obtain warranty service, please contact SAMSUNG at:

Samsung Electronics America, Inc.
85 Challenger Road
Ridgefield Park, NJ 07660-2112
1-800-SAMSUNG 726-7864 - www.samsung.com

The benefits of this Limited Warranty extend only to the original purchaser of Samsung products from an authorized Samsung reseller. THIS LIMITED WARRANTY SHALL NOT APPLY TO ANY SAMSUNG PRODUCTS PURCHASED FROM UNAUTHORIZED RESELLERS OR RETAILERS, EXCEPT IN STATES WHERE SUCH RESTRICTION MAY BE PROHIBITED. For a list of Samsung authorized retailers, please go to: http://www.samsung.com/us/peaceofmind/authorized_resellers.html.



Contact SAMSUNG WORLD WIDE

If you have any questions or comments relating to Samsung products, please contact the SAMSUNG customer care center.

Country	Customer Care Center ☎	Web Site	Address
CANADA	1-800-SAMSUNG (726-7864)	www.samsung.com/ca/support (English) www.samsung.com/ca_fr/support (French)	Samsung Electronics Canada Inc. 2050 Derry Road West Mississauga, Ontario L5N 0B9 Canada
U.S.A	1-800-SAMSUNG (726-7864)	www.samsung.com/us/support	Samsung Electronics America, Inc. 85 Challenger Road Ridgefield Park, NJ 07660

Scan the QR code to view our helpful how-to videos



Scan this QR code with your smart phone to see helpful videos.

If you experience issues, please do not take the TV back to the store.

In the United States of America, call us at 1-800-SAMSUNG (1-800-726-7864) or visit us at www.samsung.com or www.samsung.com/spsn for support and warranty service.



For more information, see "**Troubleshooting**" in this manual.

