

Use & Care Guide  
Manual de Uso y Cuidado



# Kenmore Elite®

Large Capacity Air Conditioner

Aire acondicionado de gran capacidad

Models/Modelos: 253.77180, 253. 77250

P/N 16120300A04909

Sears Brands Management Corporation  
Hoffman Estates, IL 60179 U.S.A.

[www.kenmore.com](http://www.kenmore.com)

[www.sears.com](http://www.sears.com)

[www.kmart.com](http://www.kmart.com)



---

## TABLE OF CONTENTS

Warranty .....	2	Care and Cleaning .....	9
Master Protection Agreements.....	3	Energy Saving Ideas .....	9
Important Safety Instructions.....	4	Troubleshooting Guide .....	10-11
Air conditioner Features .....	5-7	Normal Sounds .....	12
Additional Things .....	8	Call for Service .....	Back Cover

### **KENMORE ELITE LIMITED WARRANTY**

WITH PROOF OF SALE, the following warranty coverage applies when this appliance is correctly installed, operated and maintained according to all supplied instructions.

FOR ONE YEAR from the date of sale this appliance is warranted against defects in material or workmanship. A defective appliance will receive free repair or replacement at option of seller.

FOR FIVE YEARS from the date of sale, the sealed refrigerant system of this appliance is warranted against defects in material or workmanship. If a system part is defective within the first year, a new one will be supplied and installed at no charge. If a system part is defective after the first year, a new one will be supplied but not installed at no charge. You are responsible for the labor cost of part installation after the first year from the date of sale.

For warranty coverage details to obtain free repair or replacement, visit the web page: [www.kenmore.com/warranty](http://www.kenmore.com/warranty).

All warranty coverage applies for only 90 days from the date of sale if this appliance is ever used for other than private household purposes.

**This warranty covers ONLY defects in material and workmanship, and will NOT pay for:**

1. Expendable items that can wear out from normal use, including but not limited to filters, belts, bags or screw-in base light bulbs.
2. A service technician to clean or maintain this appliance, or to instruct the user in correct appliance installation, operation and maintenance.
3. Service calls to correct appliance installation not performed by Sears authorized service agents, or to repair problems with house fuses, circuit breakers, house wiring, and plumbing or gas supply systems resulting from such installation.
4. Damage to or failure of this appliance resulting from installation not performed by Sears authorized service agents, including installation that was not in accord with electrical, gas or plumbing codes.
5. Damage to or failure of this appliance, including discoloration or surface rust, if it is not correctly operated and maintained according to all supplied instructions.
6. Damage to or failure of this appliance, including discoloration or surface rust, resulting from accident, alteration, abuse, misuse or use for other than its intended purpose.
7. Damage to or failure of this appliance, including discoloration or surface rust, caused by the use of detergents, cleaners, chemicals or utensils other than those recommended in all instructions supplied with the product.
8. Damage to or failure of parts or systems resulting from unauthorized modifications made to this appliance.
9. Service to an appliance if the model and serial plate is missing, altered, or cannot easily be determined to have the appropriate certification logo.

**Disclaimer of implied warranties; limitation of remedies**

Customer's sole and exclusive remedy under this limited warranty shall be product repair or replacement as provided herein. Implied warranties, including warranties of merchantability or fitness for a particular purpose, are limited to one year on the appliance and five years on the sealed system, or the shortest period allowed by law. Seller shall not be liable for incidental or consequential damages. Some states and provinces do not allow the exclusion or limitation of incidental or consequential damages, or limitation on the duration of implied warranties of merchantability or fitness, so these exclusions or limitations may not apply to you.

This warranty applies only while this appliance is used in the United States.

This warranty gives you specific legal rights, and you may also have other rights which vary from state to state.

**Sears Brands Management Corporation, Hoffman Estates, IL 60179**

## Master Protection Agreements

Congratulations on making a smart purchase. Your new Kenmore Elite® product is designed and manufactured for years of dependable operation. But like all products, it may require preventive maintenance or repair from time to time. That's when having a Master Protection Agreement can save you money and aggravation.

The Master Protection Agreement also helps extend the life of your new product. Here's what the Agreement\* includes:

- ☑ **Parts and labor** not just for repairing defects, but to help keep products operating properly **under normal use**. Our coverage goes **well beyond the product warranty**. No deductibles, no functional failure excluded from coverage — **real protection**.
- ☑ **Expert service** by a force of more than **10,000 authorized Sears service technicians**, which means someone you can trust will be working on your product.
- ☑ **Unlimited service calls and nationwide service**, as often as you want us, whenever you want us.
- ☑ **"No-lemon" guarantee** — replacement of your covered product if four or more product failures occur within twelve months.
- ☑ **Product replacement** if your covered product can't be fixed.
- ☑ **Annual Preventive Maintenance Check** at your request — no extra charge.
- ☑ **Fast help by phone** — we call it **Rapid Resolution** — phone support from a Sears representative on all products. Think of us as a "talking owner's manual."
- ☑ **Power surge protection** against electrical damage due to power fluctuations.
- ☑ **\$250 Food Loss Protection** annually for any food spoilage that is the result of mechanical failure of any covered refrigerator or freezer.
- ☑ **Rental reimbursement** if repair of your covered product takes longer than promised.
- ☑ **25% discount** off the regular price of any non-covered repair service and related installed parts.

Once you purchase the Agreement, a simple phone call is all that it takes for you to schedule service. You can call anytime day or night, or schedule a service appointment online.

The Master Protection Agreement is a risk free purchase. If you cancel for any reason during the product warranty period, we will provide a full refund. Or, a prorated refund anytime after the product warranty period expires. Purchase your Master Protection Agreement today!

**Some limitations and exclusions apply. For prices and additional information in the U.S.A. call 1-800-827-6655.**

**\* Coverage in Canada varies on some items. For full details call Sears Canada at 1-800-361-6665.**

### Sears Installation Service

For Sears professional installation of home appliances, garage door openers, water heaters, and other major home items, in the U.S.A. call **1-844-553-6667**, and in Canada call **1-800-469-4663**.

## Read and Save These Instructions

This Use & Care Guide provides specific operating instructions for your model. Use the air conditioner only as instructed in this guide. These instructions are not meant to cover every possible condition and situation that may occur. Common sense and caution must be practiced when installing, operating, and maintaining any appliance.

### Record Your Model and Serial Numbers

Record in the space provided below the model and serial numbers. The serial plate is located on the outside of the cabinet, or behind filter at the bottom of unit. Reading the numbers may be easier by using a flashlight or by removing the cabinet front as instructed under "Care and Cleaning."

**Model Number :** \_\_\_\_\_

**Serial Number :** \_\_\_\_\_

**Purchase Date :** \_\_\_\_\_

## Important Safety Instructions

**NOTE** The power supply cord with this air conditioner contains a current detection device designed to reduce the risk of fire. Please refer to the section 'Operation of Current Device' for details. In the event that the power supply cord is damaged, it cannot be repaired, and it must be replaced with a cord from the Product manufacturer.

**WARNING** Avoid fire hazard or electric shock. Do not use an extension cord or an adaptor plug. Do not remove any prong from the power cord.

### Grounding type wall receptacle

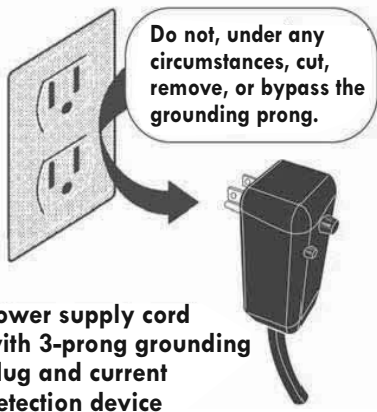

## Read all instructions before using this air conditioner.

### **WARNING** For Your Safety

Do not store or use gasoline or other flammable vapors and liquids in the vicinity of this or any other appliance. Read product labels for flammability and other warnings.

### **WARNING** Prevent Accidents

To reduce the risk of fire, electrical shock, or injury to persons when using your air conditioner, follow basic precautions, including the following:

- \* Be sure the electrical service is adequate for the model you have chosen. This information can be found on the nameplate, which is located on the side of the cabinet.
- \* If the air conditioner is to be installed in a window, you will probably want to clean both sides of the glass first. If the window is a triple-track type with a screen panel included, remove the screen completely before installation.
- \* Be sure the air conditioner has been securely and correctly installed according to the separate installation instructions provided with this manual. Save this manual and the installation instructions for possible future use in removing or reinstalling this unit.
- \* When handling the air conditioner, be careful to avoid cuts from sharp metal fins on front and rear coils.

### **WARNING** Electrical Information

The complete electrical rating of your new room air conditioner is stated on the serial plate. Refer to the rating when checking the electrical requirements.

- \* Be sure the air conditioner is properly grounded. To minimize shock and fire hazards, proper grounding is important. The power cord is equipped with a three-prong grounding plug for protection against shock hazards.
- \* Your air conditioner must be used in a properly grounded wall receptacle. If the wall receptacle you intend to use is not adequately grounded or protected by a time delay fuse or circuit breaker, have a qualified electrician install the proper receptacle.
- \* Do not run air conditioner without outside protective cover in place. This could result in mechanical damage within the air conditioner.
- \* **Do not use an extension cord or an adapter plug.**

## READ THIS SECTION BEFORE ATTEMPTING TO OPERATE AIR CONDITIONER.

Unit must be upright for one hour prior to operating.

## Operation of Current Device

Plug in & press RESET



The power supply cord contains a current device that senses damage to the power cord.

To test your power supply cord do the following:

1. Plug in the Air Conditioner.
2. The power supply cord will have TWO buttons on the plug head. Press the TEST button. You will notice a click as the RESET button pops out.
3. Press the RESET button. Again you will notice a click as the button engages.
4. The power supply cord is now supplying electricity to the unit. (On some products this is also indicated by a light on the plug head).

### NOTES:

- Do not use this device to turn the unit on or off.
- Always make sure the RESET button is pushed in for correct operation.
- The power supply cord must be replaced if it fails to reset when either the TEST button is pushed, or it cannot be reset. A new one can be obtained by contacting Sears at 1-844-553-6667.
- If power supply cord is damaged, it CANNOT be repaired. It MUST be replaced by one obtained by contacting Sears at 1-844-553-6667.

# Air Conditioner Features

## ELECTRONIC CONTROL

Before you begin, thoroughly familiarize yourself with the control panel and remote as shown below and all its functions, then touch the symbol pads for the functions you desire. **The unit can be controlled by the panel touch pads or with the remote control.**

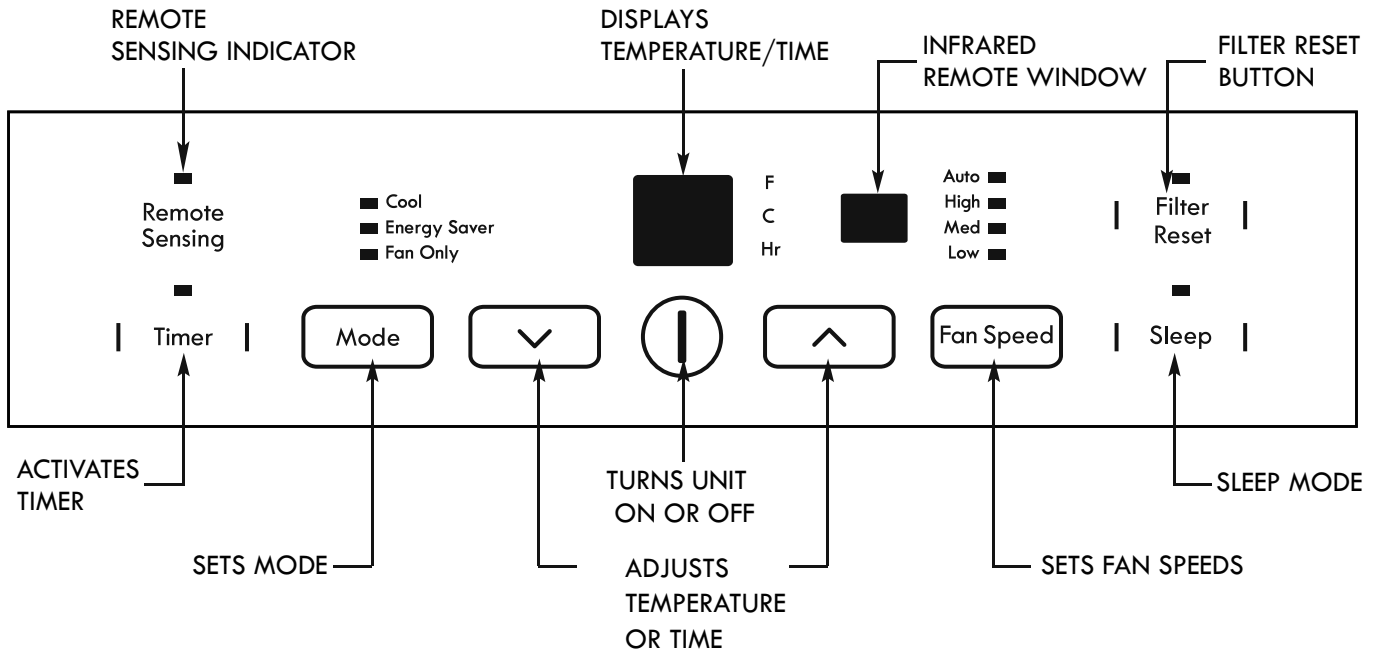

## TOUCH PAD

## REMOTE CONTROL

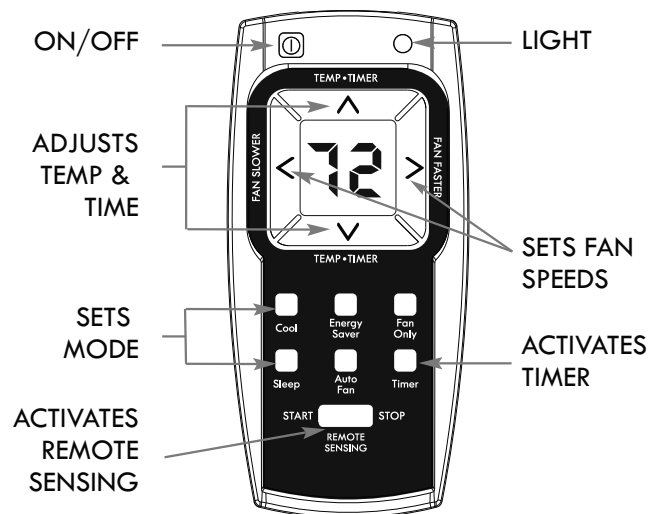

**Battery Size: AAA, Qty.: 2**

**WARNING:** Do not mix old and new batteries. Do not mix alkaline, standard (carbon-zinc), or rechargeable (nickel-cadmium) batteries.

## Air Conditioner Features (continued)

Note: The following instructions describe the Control Panel Touch Pads.

To turn unit on or off press the ON/OFF  button:

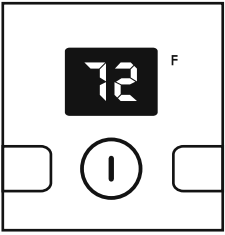

The unit is programmed to start in the energy saver mode, with auto fan speed and a temperature setting of 72 °F. These settings are required by ENERGY STAR for maximum energy efficiency. We recommend just using the temperature buttons for controlling room comfort.

To change the Temperature Setting use the UP and Down arrows as required:

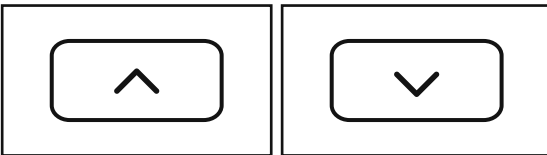

Remote Control: Use TEMP-TIMER arrows to change Temperature setting.

To use Cool, press the MODE button to select:

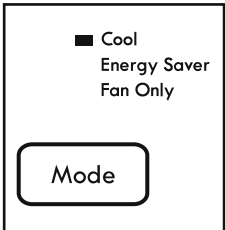

Note: In this mode, the fan remains on all the time with the compressor cycling on and off when room temperature is reached. Remote Control: Press Cool button to activate Cool function.

To adjust Fan Speeds press the Fan Speed button and select:

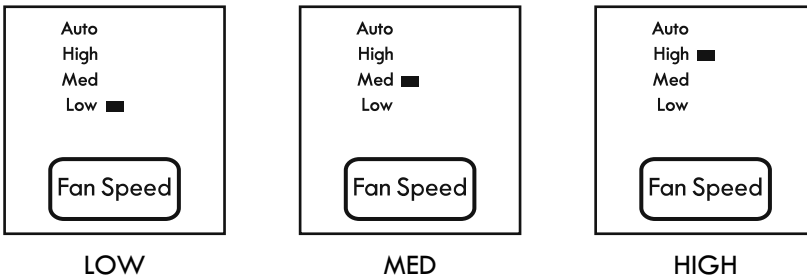

Remote Control: Use FAN SPEED arrows to adjust fan speed.

To use the Auto Fan Feature press the Fan Speed button and select AUTO:

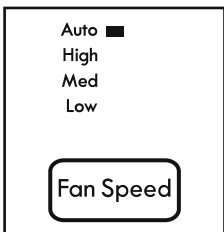

Note: Fan speed starts at high and adjusts to a slower speed as the room temperature dictates. For example, if the room doesn't get too warm it will stay at the slowest speed. If the room temperature rises quickly, such as when a door is opened, it will automatically go to the highest speed. The fan speed will re-adjust back to the slowest speed as the room returns to the original set temperature. Remote Control: Press Auto Fan button to activate Auto Fan feature.

To operate on Fan Only, press the MODE button to select:

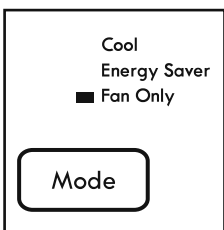

Use Fan Only function to circulate room air without air conditioner cooling. You can use any fan speed you prefer and the actual room temperature will be displayed in the DISPLAY. Remote Control: Press Fan Only button. Use Fan Speed arrows to adjust fan speed.

## Air Conditioner Features

(continued)

To use Energy Saver press the **MODE** button to select:

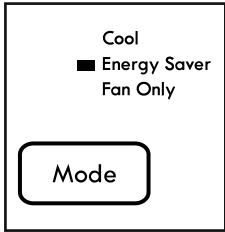

You will save energy usage in this mode. The compressor and motor will turn off once the room is at the desired temperature. The air will be sampled for 20 seconds every 10 minutes until the room is above the set temperature, at which point the compressor turns back on and the fan runs. The entire process is now repeated.

Remote Control: Press Energy Saver button to activate Energy Saver mode.

To use the Sleep feature press the **SLEEP** button and the LED will illuminate:

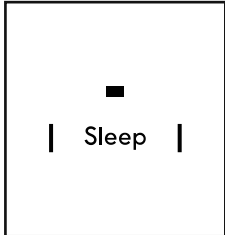

The set temperature will increase 2 °F 30 minutes after this mode is selected. It will increase again after 30 minutes by another 2 °F. It will stay at this set point for 7 hours, and then return to the original setting.

Remote Control: Press Sleep button to activate Sleep feature.

To use the Timer function press the **TIMER** button and the LED will illuminate:

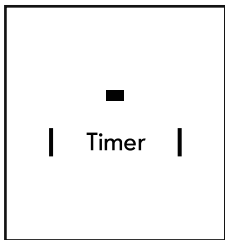

Press the UP and DOWN arrows to select the desired time up to 24 hrs. The control will count down the time remaining in 1 and 0.5 hr increments. If you need to change the set temperature, press MODE then the UP/DOWN arrows. Then after 5 seconds the display will revert to the hours remaining. This mode can be cancelled by pressing the TIMER button. The mode will operate one time, then the above steps have to be repeated.

NOTE: Timer button is functional when On/Off button is set to either On or Off. When set to On, the amount selected is the time remaining until the unit shuts Off. When set to Off, the amount is the time until the unit turns On.

Remote Control: Press Timer button to use the Timer function. Use TEMP-TIMER arrows to make adjustments.

Check Filter Feature:

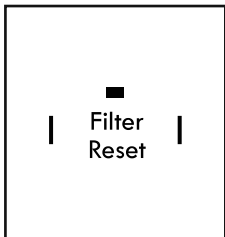

After 250 hours of operation, the Filter Reset LED will light. This is a reminder to clean the filter housed behind the front panel to keep the unit operating efficiently. Pressing the FILTER RESET button for 3 seconds will reset this reminder and turn off the LED.

Remote Sensing Feature:



PRESS REMOTE SENSING START BUTTON

LIGHT pulsing ( On & Off intermittently ).

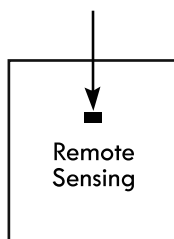

Remote Sensing allows you to transmit the room temperature and desired coolness setting from where you sit to the air conditioner. The air conditioner then cools the area where you sit to your desired coolness setting.

Note: This feature can be activated from the remote control ONLY, and the unit must be in a cooling mode.

To activate the remote sensing feature, point the remote control towards the unit and press the remote sensing Start button. Next, use the “ ^ v ” buttons to set the desired room temperature with the remote. (Note that the set temperature will only be displayed on the unit itself ). The LIGHT on the unit control will pulse to indicate it received the signal. The LIGHT on the remote control will pulse each time it sends a signal. It will periodically send this signal until the feature is deactivated by pressing the remote sensing Stop button. If the unit does not receive the remote sensing signal during any 200 second interval, the LIGHT on the unit control will turn off to indicate the remote sensing mode has ended. The display on the remote control indicates the temperature at the remote ONLY.

NOTE: The Remote Sensing function is terminated either by using the Remote Sensing Stop button or the main ON/OFF button on the unit.

## ADDITIONAL THINGS YOU SHOULD KNOW

Now that you understand the basic operation functions, here are more control features with which you should become familiar.

- \* The “cool” circuit has an automatic 3 minute time delayed start if the unit is turned off and on quickly. This prevents overheating of the compressor and possible circuit breaker tripping. The fan will continue to run during this time.
- \* There is a 2-Second delay for the compressor shutting down when selecting FAN ONLY. This is to cover the possibility of having to roll through to select another mode.
- \* The control will maintain the set temperature within 2 degrees Fahrenheit, between 60F and 90F degrees.
- \* If the unit is turned off in heat mode (if applicable) or fan only mode, it will return to the same setting when it is turned on again.
- \* When the unit is turned off in cool or energy saver mode, it will run in energy saver mode when it is turned on again, but the setting of temperature and fan speed will remain.
- \* Models with a key hole overflow drain hole can use drain kit 5304481680 to connect a 1/2 inch drain hose for safe disposal of excess system water. This part can be ordered at [www.SearsPartsDirect.com](http://www.SearsPartsDirect.com).

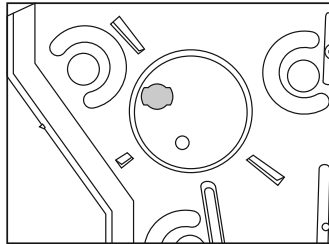

- \* The control is capable of displaying temperature in degrees Fahrenheit or degrees Celsius. To convert from one to the other and back, press and hold both the “TEMP/TIMER” Up(^) and Down(v) buttons for 3 seconds.

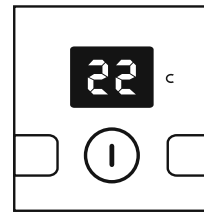
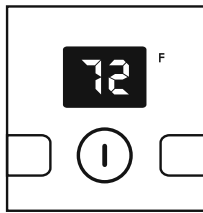

### FAULT CODES :

If the display reads “ES” or “AS”, a sensor has failed. Contact 1-844-553-6667 for repair.

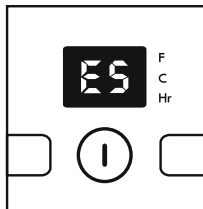

Evaporator coil sensor

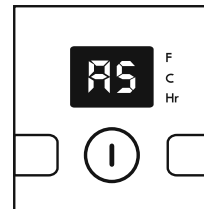

Air temperature sensor

### AUTO RE-START :

After a power outage, the unit will remember the last temperature and mode settings, and will return to these same settings once power is restored.

### FRESH AIR VENT CONTROL

1. Pushed In (Fig. 1) – Recirculates inside air
2. Partially Pulled Out (Fig. 2) – Draws fresh air into room
3. Fully Pulled Out (Fig. 3) – Exhausts air from room and draws fresh air into room

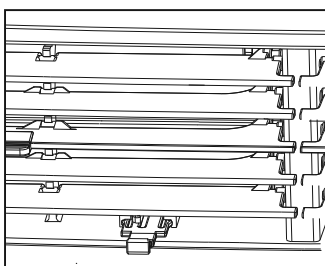

Figure 1 ( VENT CLOSED )

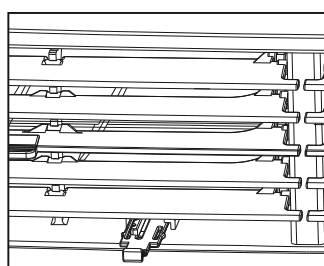

Figure 2 ( VENT OPEN )

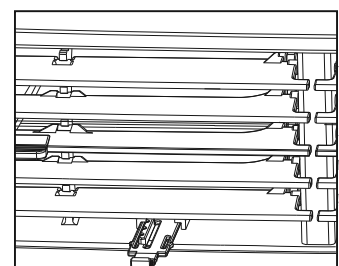
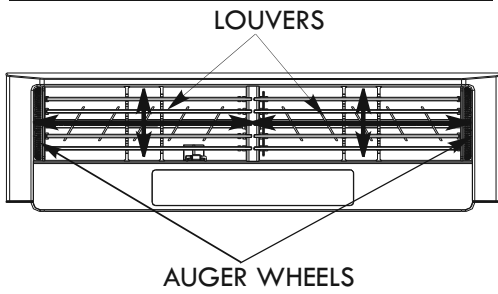

Figure 3 ( VENT & EXHAUST OPEN )





### Air Directional Louvers

Air directional louvers control air flow direction. Your air conditioner has the 8-way directional system described below.

The louvers will allow you to direct the air flow Up or Down and Left or Right throughout the room as needed. Rotate the Auger Wheels until the desired Left or Right direction is obtained. Pivot horizontal louvers with your fingertips until the desired Up/Down direction is obtained. There are a total of 8 possible air directional orientations available with this system.

## Care and Cleaning

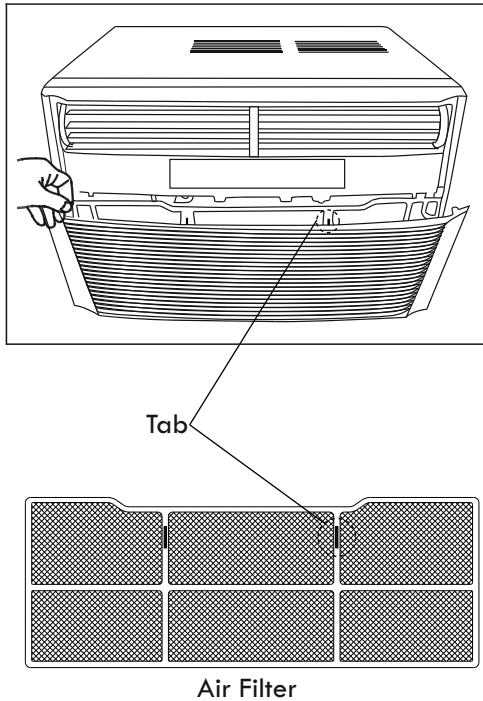

Clean your air conditioner occasionally to keep it looking new. **Be sure to unplug the unit before cleaning to prevent shock or fire hazards.**

### Air Filter Cleaning

The air filter should be checked at least once a month to see if cleaning is necessary.

Trapped particles in the filter can build up and block air from flowing to cooling coils and cause an accumulation of frost on the cooling coils.

- On models with Fresh Air Vent Control, push in control to vent closed position.
- Open the front panel.
- Grasp the filter by the center and pull up and out.
- Wash the filter using liquid dishwashing detergent and warm water. Rinse filter thoroughly. Gently shake excess water from the filter. Be sure filter is thoroughly dry before replacing.
- Or instead of washing, you may vacuum the filter clean.

**NOTE:** When replacing the air filter after cleaning, make sure the tabs on the air filter are on the upper part of filter, and placed outward as shown in the drawing on the left side.

### Cabinet Cleaning

- Be sure to unplug the air conditioner to prevent shock or fire hazard. The cabinet and front may be dusted with an oil-free cloth or washed with a cloth dampened in a solution of warm water and mild liquid dishwashing detergent. Rinse thoroughly and wipe dry.
- Never use harsh cleaners, wax or polish on the cabinet front.
- Be sure to wring excess water from the cloth before wiping around the controls. Excess water in or around the controls may cause damage to the air conditioner.
- Plug in air conditioner.

### Winter Storage

If you plan to store the air conditioner during the winter, remove it carefully from the window according to the installation instructions. Cover it with cloth or return it to the original carton.

**NOTE: Store air conditioner in a dry place in upright position (horizontal with base down).**

## Energy Saving Ideas

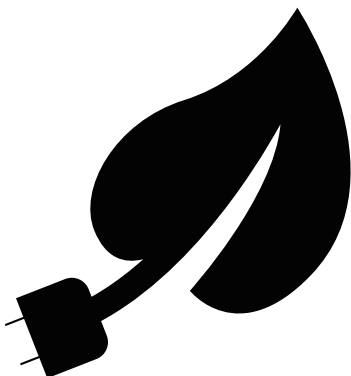

- \* The capacity of the room air conditioner must fit the room size for efficient and satisfactory operation.
- \* Install the room air conditioner on the shady side of your home. A window that faces north is best because it is shaded most of the day.
- \* Do not block inside airflow around air conditioner with blinds, curtains or furniture; or outside with shrubs, enclosures, or other buildings.
- \* Close the fireplace damper, floor and wall registers so cool air does not escape up the chimney and into the duct work.
- \* Keep blinds and drapes in other windows closed during the sunniest part of the day.
- \* Clean the air filter as recommended in the section "Care and Cleaning."
- \* Proper insulation and weather stripping in your home will help keep warm air out and cool air in.
- \* External house shading with trees, plants or awnings will help reduce the air conditioner's work load.
- \* Operate heat producing appliances such as ranges, washers, dryers and dishwashers during the coolest part of the day.



## Room Air Conditioner Troubleshooting Guide

### THE AIR CONDITIONER WILL NOT OPERATE

Check if ...	Then ...
Power supply cord is disconnected	Firmly push the cord into a live wall outlet having proper voltage. (Page 4)
Power Cord has tripped	Press the RESET button on the plug head. (Page 4)
House fuse has blown or circuit breaker tripped	Replace the fuse with a time delay type or reset the circuit breaker. (Page 4)
Power is OFF.	Push ON/OFF Button to turn ON. (Page 6)
Temperature setting is warmer than room temperature.	Set temperature to a lower setting. (Page 6)
Unit was turned OFF and ON too quickly.	Built-in delay will prevent compressor from turning on for 3 minutes.
Timer shut unit OFF.	Push ON/OFF Button to turn unit ON. (Page 6)
Touch Pad and Remote not responding.	Unit is in a locked mode. Unplug unit for 10 seconds, and then plug in again and the controls will reset. (Page 4)

### THE AIR CONDITIONER BLOWS FUSES OR TRIPS CIRCUIT BREAKER

Check if ...	Then ...
House fuse has blown or circuit breaker tripped.	Replace the fuse with a time delay type or reset the circuit breaker. (Page 4)
Too many electrical devices are being used on the same circuit.	Unplug or relocate electrical devices being shared on same circuit.
Unit is rated over 7.5 amps.	Unit should be plugged into a single circuit outlet.
Unit is plugged into an extension cord.	Do not use an extension cord to run the unit. (Page 4)
Unit was turned OFF and ON too quickly.	Turn unit OFF and wait 3 minutes before restarting. (Page 6)

### THE AIR CONDITIONER TURNS ON AND OFF BY ITSELF

Check if ...	Then ...
Outside temperature is extremely hot.	Set fan speed at the fastest setting for maximum cooling. (Page 6)
ENERGY SAVER feature is on.	ENERGY SAVER feature does not circulate air continually. Set mode to COOL for constant air circulation. (Page 5)
Timer turned unit ON or shut unit OFF.	Push ON/OFF Button to turn unit ON or OFF. (Page 6)

### THE AIR CONDITIONER DOES NOT COOL THE ROOM - ICE BEHIND FRONT PANEL

Check if ...	Then ...
Outside temperature is below 60°F.	Set mode to FAN ONLY and fan speed to fastest setting to defrost coil. (Page 6)
Filter is dirty.	Open front panel. Remove filter. Rinse or vacuum filter. Replace filter. Close Panel (Page 9)
BTU size is too large.	A lower capacity unit may be required depending on the size of the room being cooled. (Page 9)

### THE AIR CONDITIONER DOES NOT COOL THE ROOM - NO ICE BEHIND FRONT PANEL

Check if ...	Then ...
Filter is dirty.	Open front panel. Remove filter. Rinse or vacuum filter. Replace filter. Close Panel (Page 9)
Temperature setting is warmer than room temperature.	Set temperature to a lower setting. (Page 6)
Room temperature is below 60°F.	Unit is not designed to cool below 60°F. (Page 8)
Front of unit is blocked by furniture, drapes, blinds, etc.	Clear away area in front of unit.
Back of unit is blocked by leaves, dirt, branches, etc.	Clear away back of unit.
Doors, windows, registers, etc. are open.	Close doors, windows, registers, etc.
Unit recently turned on.	Allow time to cool a larger room.
Temperature sensor is touching the coil.	Open front panel. Remove filter. Turn end of temperature sensor away from coil. Replace filter. Close panel.
Excessive heat in the room being cooled.	Use exhaust vents while cooking or bathing. Limit use of heat producing appliances during the hottest part of the day. (Page 9)
Vent control is pulled open.	Push in vent control for maximum cooling. (Page 8) (CLOSED POSITION)

# Room Air Conditioner Troubleshooting Guide

(Continued)

## THE AIR CONDITIONER RUNS TOO MUCH

Check if ...	Then ...
Energy Saver is chosen.	Inside blower continues operating for one minute to use as much cooling that is available in the evaporator.
Current Unit replaced an older unit.	Newer, higher efficiency Air Conditioner may run longer to cool the room. Total energy consumption is less due to higher efficiency.
BTU size is too small.	A higher capacity unit may be required depending on the size of the room being cooled. (Page 9)

## WATER DRIPPING FROM AIR CONDITIONER - INSIDE ROOM

Check if ...	Then ...
Unit is not properly installed.	Unit should be mounted on a 1/4" downward slope to the outside (1/2 bubble on a carpenter's level) to provide proper drainage. Reposition or shim cabinet as necessary. DO NOT drill drain pan.

## WATER DRIPPING FROM AIR CONDITIONER - OUTSIDE ROOM

Check if ...	Then ...
Room is hot and humid.	Normal operation during hot and humid days.

## THE REMOTE WILL NOT OPERATE AIR CONDITIONER

Check if ...	Then ...
Batteries are not installed properly.	Verify batteries are installed properly. (Page 5)
Red light does not flash on the remote when the remote buttons are pressed.	Verify batteries are installed properly. Install a new set of batteries. (Page 5)
The remote is pointed at the unit.	The remote may not work properly when used at extreme angles to the front of the unit.

## TYPICAL AIR CONDITIONER SOUNDS YOU MAY HEAR

Check if ...	Then ...
High pitched whine or pulsating noise that cycles on and off.	Compressor - Normal noise due to modern high efficiency compressors. (Page 12)
Rushing air sound.	Fan/Motor - Normal noise of higher efficiency fans pushing air further into the room. (Page 12)
Pinging or swishing sounds.	Condenser - Normal noise of water hitting the condenser to increase energy efficiency. (Page 12)
Gurgling or hissing sounds.	Evaporator - Normal noise of refrigerant passing through evaporation. (Page 12)
Beeping.	Electronic Control - Normal noise when electronic control settings are changed.
Vibration.	Unit Vibration - Due to poor wall or window construction or incorrect installation. (Page 12)

## REMOTE SENSING DEACTIVATING PREMATURELY

Check if ...	Then ...
Remote control not located within range.	Place remote control within 10 feet & 120° angle radius of the front of the unit.
Remote control signal obstructed.	Remove obstruction.

## ROOM TOO COLD

Check if ...	Then ...
Set temperature too low.	Increase set temperature.
Remote Sensing activated and remote control located in Hot Spot	Relocate remote control or deactivate remote sensing.

## Normal Sounds

Sound of Rushing Air  
At the front of the unit, you may hear the sound of rushing air being moved by the fan.

Gurgle/Hiss  
“Gurgling or hissing” noise may be heard due to refrigerant passing through evaporator during normal operation.

High Pitched Whine  
Today’s high efficiency compressors may have a high pitched whine during the cooling cycle.

Vibration  
Unit may vibrate and make noise because of poor wall or window construction or incorrect installation.

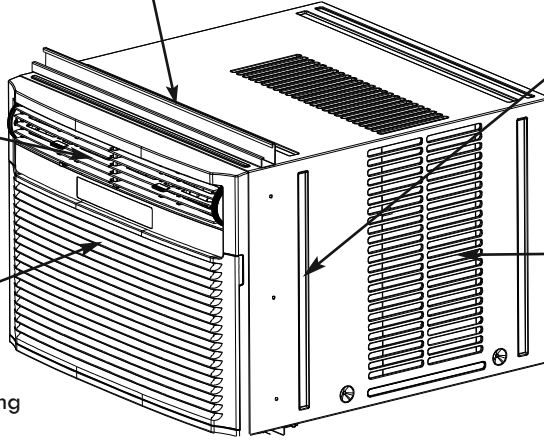

Pinging or Swishing  
Droplets of water hitting condenser during normal operation may cause “pinging or swishing” sounds.  
**Note: Don't try to drill any holes on the base pan to eliminate the normal sounds otherwise it will void the warranty.**

# Kenmore®

For Sears Home Services in-home repair  
of all Kenmore major appliances.

For the replacement parts, accessories and  
Use & Care Guides that you need to do-it-yourself.

For professional installation of major home appliances  
and items like air conditioners and water heaters.

## 1-844-553-6667

[www.kenmore.com](http://www.kenmore.com)

In Canada 1-800-469-4663

[www.sears.ca](http://www.sears.ca)

---

Call anytime for the location of your nearest  
**Sears Parts & Repair Service Center**

1-800-488-1222 (U.S.A.)

1-800-469-4663 (Canada)

---

To purchase a protection agreement on a serviceable product:

1-800-827-6655 (U.S.A.)

1-800-361-6665 (Canada)

---

Para pedir servicio de reparación  
a domicilio, y ordenar piezas:

**1-888-SU-HOGAR®**

(1-888-784-6427)

[www.kenmore.com](http://www.kenmore.com)

Au Canada pour service en français:

**1-800-LE-FOYER<sup>MC</sup>**

(1-800-533-6937)

[www.sears.ca](http://www.sears.ca)

