

Shark[®]

S4701 Series

OWNER'S GUIDE



IMPORTANT SAFETY INSTRUCTIONS

For Household Use Only

WHEN USING YOUR SHARK® 2-IN-1 BLAST & SCRUB STEAM POCKET® MOP, BASIC SAFETY PRECAUTIONS SHOULD ALWAYS BE FOLLOWED, INCLUDING THE FOLLOWING:

READ ALL INSTRUCTIONS BEFORE USING YOUR SHARK 2-IN-1 BLAST & SCRUB STEAM POCKET MOP.

 **WARNING: DANGER OF SCALDING.** The steam emitted from the Steam Mop is very hot and may cause scalding. Please use caution when using the Steam Mop.

 **WARNING: KEEP STEAM MOP AWAY FROM CHILDREN.**

POLARIZED PLUG:

This Steam Mop has a polarized plug (one blade is wider than the other). As a safety feature, this plug will fit into a polarized outlet only one way. If the plug does not fit fully into the outlet, reverse the plug. If it still does not fit, contact a qualified electrician. Do not attempt to defeat this safety feature.

 **WARNING:** TO REDUCE THE RISK OF FIRE, ELECTRIC SHOCK OR INJURY:

1.  **CAUTION:** When in use, never turn the Steam Mop over or on its side. Never direct steam toward people, pets, or plants.
2. Always unplug and allow the Steam Mop to cool before attaching or removing accessories.
3. Use the Steam Mop only for its intended use.
4. **DO NOT** use for space-heating purposes.
5. **DO NOT** use outdoors.
6. **DO NOT** leave the Steam Mop unattended when plugged in. Always unplug the power cord from the electrical outlet when not in use and before servicing.
7. **DO NOT** allow the Steam Mop to be used by children. Close attention is necessary when used near children, pets, or plants.
8. Use only as described in this manual.
9. Use only manufacturer's recommended accessories.
10. **DO NOT** use with damaged cord or plug. If Steam Mop is not working as it should or has been dropped, damaged, left outdoors, or dropped into water, return it to EURO-PRO Operating LLC for examination and repair. Incorrect re-assembly or repair can cause a risk of electrical shock or injury to persons when the Steam Mop is used.
11. To protect against a risk of electric shock, **DO NOT** immerse the Steam Mop in water or any other liquids.

12. **DO NOT** handle plug or Steam Mop with wet hands or operate the Steam Mop without wearing shoes.
13. **DO NOT** pull or carry by cord, use cord as a handle, close a door on cord, or pull cord around sharp edges or corners. Do not run Steam Mop over cord. Keep cord away from heated surfaces.
14. **DO NOT** unplug by pulling on power cord. To unplug, grasp the plug not the power cord. Do not use extension cords or outlets with inadequate current-carrying capacity.
15. **DO NOT** put any objects into the the Steam Nozzle openings. Discontinue use if the steam nozzle is blocked.
16. **DO NOT** put hands or feet under the Steam Mop—it gets very hot.
17. When mopping, use **ONLY** on flat, horizontal surfaces. Do not use on walls, counters, or windows.
18. **DO NOT** use on leather, wax-polished furniture, synthetic fabrics, velvet, or other delicate, steam-sensitive materials.
19. **DO NOT** use on electronics, such as televisions, video game consoles, and cable boxes.
20. **DO NOT** add cleaning solutions, vinegar, scented perfumes, oils, or any other chemicals to the water used in the Steam Mop as this may damage it or make it unsafe for use. If you live in a hard-water area, we recommend using distilled water in your Steam Mop.
21. **Never leave any wet Cleaning Pad in one spot while using or storing for any period of time, as this may damage your surfaces.**
22. Carefully remove all Cleaning Pads after you have unplugged and allowed the Steam Mop to cool.
23. When cleaning the exterior of the Steam Mop, unplug the power cord from the electrical outlet and clean with a dry or damp cloth. Do not pour water or use alcohol, benzene, or paint thinner on the Steam Mop.
24. Extreme caution should be exercised when using the Steam Mop to clean stairs.
25. Keep your work area well lit.
26. Store Steam Mop indoors in a cool, dry place.
27. To avoid circuit overload, do not operate another appliance on the same socket (circuit) as the Steam Mop.
29. To avoid scalding injuries, always unplug and allow the Steam Mop to cool before removing or changing Mop Heads, Accessories, or Cleaning Pads.

⚠ WARNING: Your Steam Mop is designed to clean hard-floor surfaces that will withstand high heat. Do not use on unsealed wood or unglazed ceramic floors. On surfaces that have been treated with wax and on some no-wax floors, the sheen may be removed by the heat and steam action. It is always recommended to test an isolated area of the surface to be cleaned before proceeding. We also recommend that you check the use and care instructions from the floor manufacturer.

SAVE THESE INSTRUCTIONS

Thank you for purchasing the Shark® 2-in-1 Blast & Scrub Steam Pocket® Mop.

This Owner's Guide is designed to help you get a complete understanding of your new Steam Mop. Please read it carefully and keep for future reference.

For a list of what is included with this model, refer to inside flap of box.

If you should have a question about your Shark® 2-in-1 Blast & Scrub Steam Pocket® Mop, please call Shark Customer Service at 1-800-798-7398.

REGISTER YOUR PURCHASE:

www.sharkclean.com

1-800-798-7398

RECORD THIS INFORMATION:

Model Number: _____

Date of Purchase (Keep receipt): _____

TECHNICAL SPECIFICATIONS:

Voltage: 120 V., 60 Hz

Watts: 1200W

Water Capacity: 410 ml (13 oz.)



Contents

**Thank you for
purchasing the
Shark® 2-in-1
Blast & Scrub
Steam Pocket®
Mop.**

| | |
|--|----|
| Getting Started..... | 5 |
| Assembling Your Steam Mop | 7 |
| Using Your Steam Mop | 8 |
| Using Your Handheld Steamer..... | 10 |
| Using the Precision Clean Pocket Accessory..... | 12 |
| Using the Total Clean Pocket Accessory..... | 12 |
| Using the Scrub Blast Accessory..... | 13 |
| Using the EZ Reach Bending Duster Accessory..... | 13 |
| Using the Flat Scrubber Accessory..... | 14 |
| Using the Steam Duster Accessory..... | 14 |
| Caring for Your Steam Mop..... | 15 |
| Ordering Optional Accessories..... | 17 |
| Troubleshooting Guide..... | 19 |
| Frequently Asked Questions..... | 21 |
| Warranty..... | 22 |

Getting Started

When assembling your Steam Mop there may be a little water in or around the water tank. This is because we test all our Steam Mops before you buy them, so you get a quality **Shark® 2-in-1 Blast & Scrub Steam Pocket® Mop**.

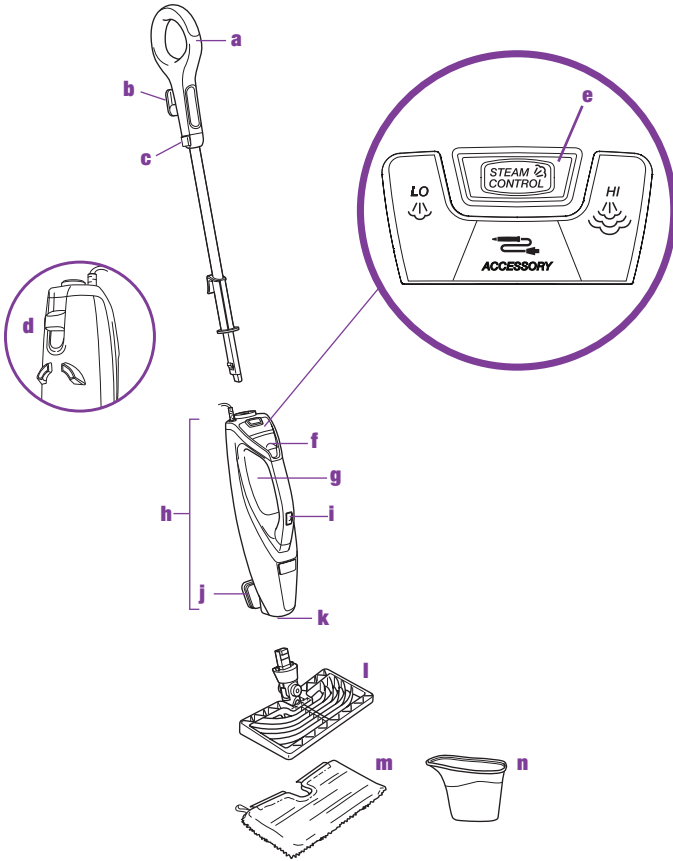





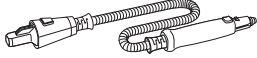

- a** Mop Handle
- b** Quick-Release Swivel Cord Wrap
- c** Cord Management Clip
- d** Engage Scrubber/Release Head
- e** Steam Control Button
- f** Water Tank Lid
- g** Water Tank

- h** Mop Body
- i** Steam Control Button for Above-Floor Mode
- j** Stain Scrubber
- k** Steam Nozzle
- l** Rectangle Mop Head
- m** Pocket Pad for Rectangle Mop Head
- n** Filling Flask

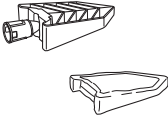
For a full list of what is included with your Steam Mop, please refer to the inside flap of your box.

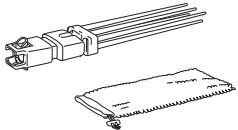
⚠ CAUTION: Test in a small inconspicuous area and contact your surface manufacturer/installer for specific information on your surface.

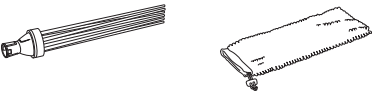
| HANDHELD ACCESSORIES | |
|--|---|
| <p>ACCESSORY HOSE</p> <p>The Shark® 2-in-1 Blast & Scrub Steam Pocket® Mop comes with an assortment of accessories that easily attach to the Accessory Hose for optimal range and mobility.</p> |  |
| <p>SCRUB BLAST ACCESSORY & PAD</p> <p>Ideal for large, flat surfaces. Do not use without the Scrub Blast Pad attached.</p> |  |
| <p>TOTAL CLEAN POCKET ACCESSORY & PAD</p> <p>Ideal for flat surfaces, corners, and edges. Do not use without a Total Clean Pocket Pad attached.</p> |  |
| <p>PRECISION CLEAN POCKET ACCESSORY & PAD</p> <p>Ideal for small uneven surfaces, corners, and edges. Do not use without a Precision Clean Pocket Pad attached.</p> |  |
| <p>EZ REACH BENDING STEAM DUSTER & PAD</p> <p>Ideal for cleaning and dusting a variety of surfaces, like large areas, especially hard-to-reach places, and crevices. Do not use without the EZ Reach Bending Steam Duster Pad attached.</p> |  |
| <p>FLAT SCRUBBER ACCESSORY & PAD</p> <p>Ideal for dusting a variety of surfaces, especially hard-to-reach ones. Do not use without the Flat Scrubber Pad attached.</p> |  |
| <p>STEAM DUSTER ACCESSORY & PAD</p> <p>Ideal for cleaning and dusting a variety of surfaces, like large areas, hard-to-reach places, and crevices. Do not use without the Steam Duster Pad attached.</p> |  |

Assembling Your Steam Mop

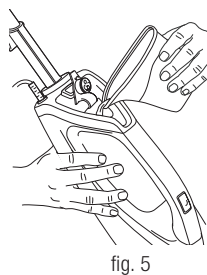
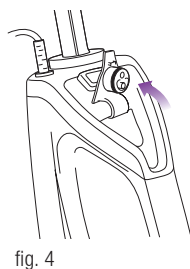
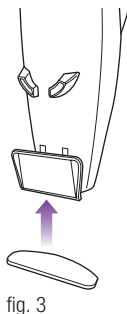
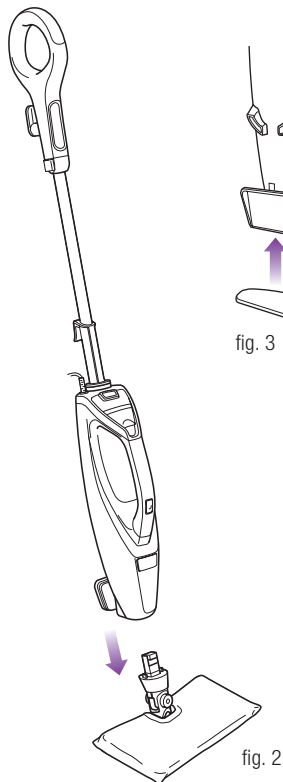
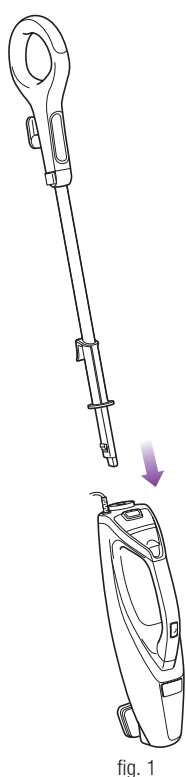

- ⚠ WARNING:** Always make sure the Steam Mop is **UNPLUGGED** from the wall when not in use. Never fill the Steam Mop, attach the Mop Head, or change or remove the Pocket Pad when the Steam Mop is plugged into the wall. Unplug from the wall and allow to cool before you fill the Steam Mop, attach or remove the Mop Head, or change or remove the Cleaning Pad. To prolong the life of your Steam Mop, we recommend using distilled water. Make sure you add only water to the tank. Chemicals or cleaning solutions (including vinegar) may damage the Steam Mop and could be unsafe for you and your family.

STEAM MOP ASSEMBLY

- 1 Insert the Mop Handle into the Mop Body. (fig. 1) Push the Mop Handle in until you hear it click into place.

- 2 Select the Rectangle Mop Head and Pocket Pad. If the Pocket Pad is not already attached, fit one side of the Pocket Pad onto the Mop Head first, then, using the loop, pull the Pocket Pad over the Mop Head. Attach the hook-and-loop fasteners on the top of the Pocket Pad to secure it in place.
- 3 Insert the Mop Head into the Mop Body. Push until you hear it click into place (fig. 2).
- 4 Attach the Scrubbing Pad to the hook-and-loop surface of the Stain Scrubber (fig. 3).
- 5 Pull up on the Water Tank Cap to open (fig. 4).
- 6 Use the Filling Flask to pour water into the Water Tank (fig. 5). Do not overfill. Press the Water Tank Cap firmly to close it.

NOTE: Steps 2–6 also apply to the Triangle Mop Head.

NOTE: The Triangle Mop Head may not be included with your product. See box for specific product details.

Using Your Steam Mop

IMPORTANT: Make sure you do not use the Steam Mop without attaching a Pocket Pad and adding water to the Water Tank first. When you are using the Steam Mop for the first time, it might take longer than the normal 30 seconds to start steaming.

IMPORTANT: Do not use on unsealed wood or unglazed ceramic floors. On surfaces that have been treated with wax and on some no-wax floors, the sheen may be removed by the heat and steam action. Test an isolated area of the surface to be cleaned before proceeding. Check the use and care instructions from the floor manufacturer.

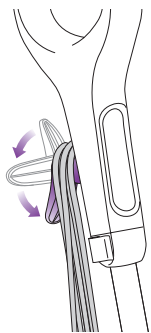

fig. 6

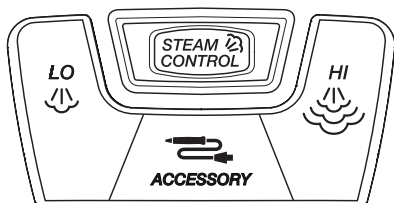

fig. 7



fig. 8

NOTE: To prolong the life of your Steam Mop, we recommend using distilled water.

NOTE: Sweep or vacuum your floors prior to cleaning with your Steam Mop.

- 1 Pull and twist the Quick-Release Cord Holder to unwrap the power cord completely (**fig. 6**). Plug into an electrical outlet.
- 2 The Steam Mop will be in Standby Mode as soon as it is plugged in. The Standby Mode can be identified by a blinking light around the Steam Control Button (**fig. 7**).
- 3 Press the Steam Control Button to select either the **LO** or **HI** Setting (the **ACCESSORY** Setting is not available for floor cleaning) (**fig. 7**). Press once for the low setting, twice for **HI**, and three times to return to Standby Mode. Once in Standby Mode, a light will blink around the Steam Control Button, but all other Steam Setting Lights will be off.
- 4 Clean your floors with a forward and backward motion.
- 5 When you come to a tough, dried-on floor stain, use the Steam Blast Scrub Mode to clean it away.

- 6 To engage the Steam Blast Scrub Mode, slide the Engage Scrubber/Release Head Button all the way down until you hear a click (**fig. 8**). The Stain Scrubber will automatically pop into position. Lift the Mop Body off the Mop Head and place the Stain Scrubber on the floor to start scrubbing.

⚠ CAUTION: While in Scrub Blast Mode, do not leave the Steam Mop stationary.



⚠ CAUTION: Do not Scrub any one area for an extended period of time.

- 7 To go back to mopping, re-dock the Mop Body onto the Mop Head. The Stain Scrubber will automatically retract.
- 8 When you are done mopping, press the Steam Control Button until you return to Standby Mode.
- 9 When the Water Tank is empty, the Steam Mop will stop producing steam. You can refill the Water Tank at any time as long as the Steam Mop is unplugged. Follow the Water Tank filling instructions on page 7.

NOTE: Please wait 2 to 3 minutes for the Steam Mop to cool off before switching the Mop Head or Cleaning Pad. Never leave the Steam Mop with a damp/wet Cleaning Pad on any floor.

Using Your Steam Mop - continued

The Shark® 2-in-1 Blast & Scrub Steam Pocket® Mop has Intelligent steam settings that allow you to select the right amount of steam for your floors and produces greater steam for your accessories. See below for tips on when to use each setting.

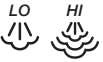
| SETTING | IDEAL FOR THESE SURFACES | RECOMMENDED USAGE |
|---|--|--|
| LO  | Laminate Hardwood Marble | Cleaning delicate surfaces Light cleaning and dusting Loosening and lifting light dirt Sanitizing floors |
| HI  | Hardwood Marble Tile Stone | Cleaning most surfaces and large areas Basic, everyday cleaning Removing spots and smaller messes Cleaning moderate- and heavy-traffic areas Sanitizing floors |
|  ACCESSORY | Sealed above-floor hard surfaces around the house | Dusting or cleaning above-floor sealed hard surfaces. |
| SCRUB BLAST  | To engage the Scrub Blast Mode, slide the Engage Scrubber/Release Head Button down until you hear a click. The Stain Scrubber will automatically pop in to position. Lift the Mop body off the Mop Head and place the Stain Scrubber on the floor to start scrubbing. You can select your preferred level of steam. Use LO Setting for low-moisture scrubbing. Use the HI Setting for stubborn, stuck-on stains. | |

TO SANITIZE* WITH THE RECTANGLE MOP HEAD

- 1 Start with a clean Pocket Pad.
- 2 Plug in the unit and press the Steam Control Button to select either the **LO** or **HI** Setting.
- 3 Wait 30 seconds for the unit to begin producing steam.
- 4 Start mopping on an appropriate sealed hard-floor surface with a forward and backward motion. After three minutes, your unit is ready to be used to sanitize.
- 5 Using a forward and backward motion, move the unit over the area you seek to sanitize. Repeat at least 15 times.

* Sanitization studies were conducted under controlled test conditions. Household conditions and results may vary. With Rectangle Mop Head only. Not with Above-Floor Accessories or in Blast & Scrub mode.

Using Your Handheld Steamer

Your **Shark® Steam Blast 2-in-1 Steam Pocket® Mop** can be converted to a Handheld Steamer that is designed to clean surfaces that can withstand high heat and moisture. Do not use on unsealed wood surfaces (especially antique wood furniture), unglazed ceramic tile, painted surfaces, or surfaces that have been treated with wax, oils, varnishes, or shellac. The sheen may be removed by the heat, steam, and friction of the cleaning Accessories. It is always recommended to test an isolated area of the surface to be cleaned before proceeding.

We also recommend you check the use and care instructions from the surface manufacturer.

When cleaning finished wood surfaces, use broad, continuous strokes. To prevent surface damage, avoid focusing steam or allowing the cleaning Accessories to remain stationary in any one spot.

NOTE: To ensure constant steam flow, make sure the Steam Nozzle is not facing upward.

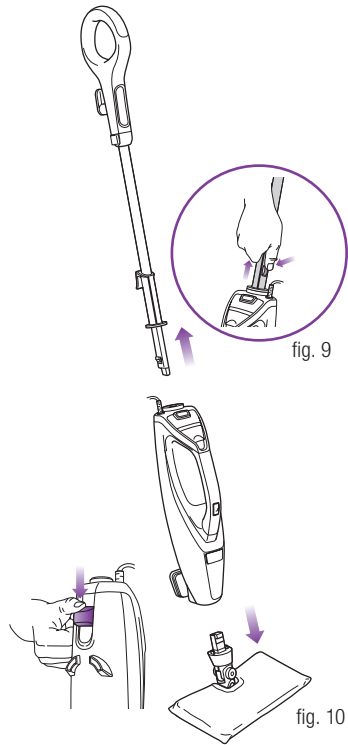

⚠ CAUTION: To avoid scalding injuries, always unplug and allow the Steam Mop to cool before transitioning it to the Handheld Steamer.

- 1** To transition the Handheld Steamer, press and hold down the Handle Release Button while pulling out the Mop Handle (**fig. 9**).
- 2** To remove the Mop Head, press down on the Engage Scrubber/Release Head Button and lift the Mop Body off the Mop Head (**fig. 10**).

NOTE: When you remove the Mop Handle, steam will automatically stop.

NOTE: Do not leave the wet Mop Head on any floor for a prolonged period of time.

Using Your Handheld Steamer - continued



CAUTION: Make sure the Steam Mop is unplugged or in Standby Mode while attaching or removing the Accessory Hose from the Steam Nozzle.

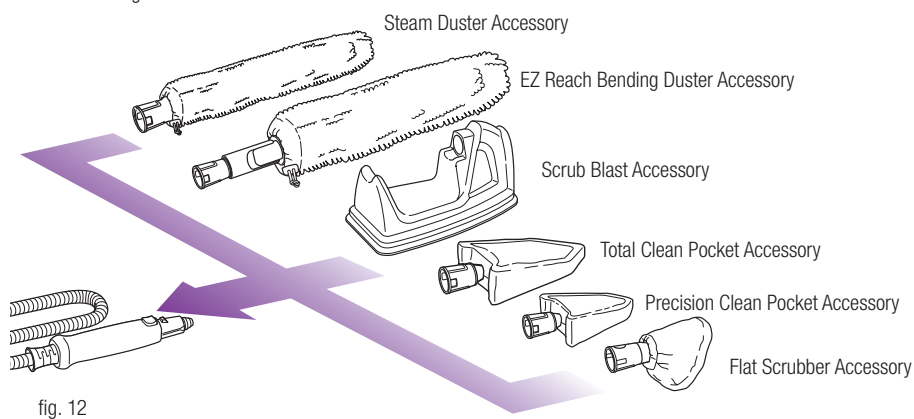
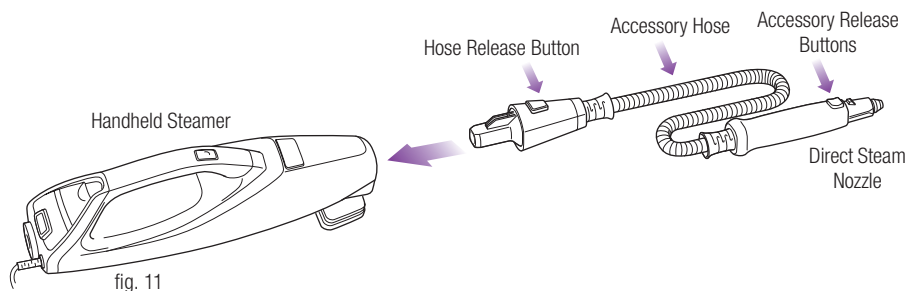

NOTE: Some accessories may not be included with your product. See box for specific product details.

- 3 First attach the Accessory Hose to the Handheld Steamer by snapping the Accessory Hose into the Steam Nozzle (**fig. 11**).
- 4 Select the desired cleaning accessory. Follow the Accessory sub-assembly instructions (pages 12–14). Then insert the Direct Steam Nozzle into the Accessory (**fig. 12**).
- 5 To remove the Accessory Hose, press and hold down the Hose Release Button, then slide out the Accessory Hose.

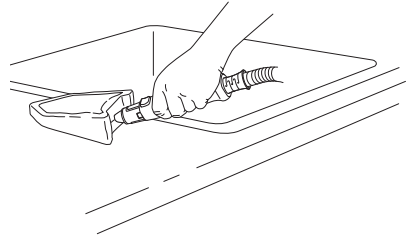
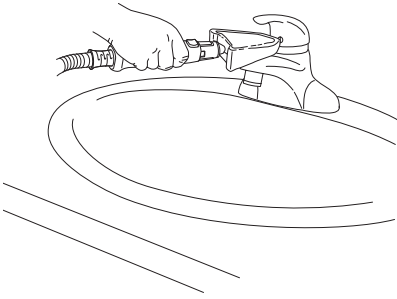

USING THE PRECISION CLEAN POCKET ACCESSORY

Cleaning Tip: The Precision Clean Pocket Accessory is ideal for small, uneven surfaces. The pointed tip is great for edges and corners.

- ▲ **CAUTION:** Make sure the Steam Mop is unplugged or in Standby Mode while attaching or removing the Precision Clean Pocket Accessory. Avoid touching the Accessory, as it will be very hot after steaming.
 - ▲ **CAUTION:** To avoid scalding injuries, always unplug and allow the Steam Mop to cool before removing or changing Accessories or Cleaning Pads.
 - ▲ **CAUTION:** Do not use on wallpaper.
- 1 Slide the Precision Clean Pocket Pad over the Precision Clean Pocket Accessory so it fits snugly.
 - 2 Cinch the elastic band and slide the locking toggle to tighten.
 - 3 Attach the Precision Clean Pocket Accessory by connecting it to the Direct Steam Nozzle until it clicks into place.
 - 4 When you press the Steam Control Button Accessory Mode (**ACCESSORY**) will automatically be selected and you can begin cleaning (**LO** and **HI** Settings are not available for above-floor cleaning).
 - 5 To remove the Precision Clean Pocket Accessory, squeeze the Accessory Release Buttons, then slide out the Accessory.

USING THE TOTAL CLEAN POCKET ACCESSORY

Cleaning Tip: The Total Clean Pocket Accessory is ideal for large, flat surfaces. The pointed tip is great for edges and corners.

- ▲ **CAUTION:** Make sure the Steam Mop is unplugged or in Standby Mode while attaching or removing the Total Clean Pocket Accessory. Avoid touching the Accessory, as it will be very hot after steaming.
 - ▲ **CAUTION:** To avoid scalding injuries, always unplug and allow the Steam Mop to cool before removing or changing Accessories or Cleaning Pads.
 - ▲ **CAUTION:** Do not use on wallpaper.
- 1 Slide the Total Clean Pocket Pad over the Total Clean Pocket Accessory so it fits snugly.
 - 2 Cinch the elastic band and slide the locking toggle to tighten.
 - 3 Attach the Total Clean Pocket Accessory by connecting it to the Direct Steam Nozzle until it clicks into place.
 - 4 When you press the Steam Control Button Accessory Mode (**ACCESSORY**) will automatically be selected and you can begin cleaning (**LO** and **HI** Settings are not available for above-floor cleaning).
 - 5 To remove the Total Clean Pocket Accessory, squeeze the Accessory Release Buttons, then slide out the Accessory.

Using Your Handheld Steamer - continued

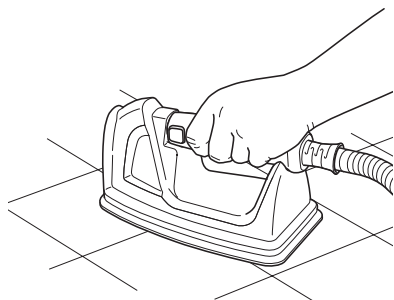

USING THE SCRUB BLAST ACCESSORY

Cleaning Tip: The Scrub Blast Accessory is ideal for large, flat surfaces. Its design allows you to apply more force when scrubbing, which redistributes the steam toward the Cleaning Pad when pressed against a surface.

CAUTION: Make sure the Steam Mop is unplugged or in Standby Mode while attaching or removing the Scrub Blast Accessory. Avoid touching the Accessory, as it will be very hot after steaming.

CAUTION: To avoid scalding injuries, always unplug and allow the Steam Mop to cool before removing or changing Accessories or Cleaning Pads.

CAUTION: Do not use on wallpaper.

CAUTION: This is not an iron. Do not use on garments or soft surfaces. It may result in damage.

- 1 To attach the Scrub Blast Pad, place it exterior side down on a flat surface, then set the Scrub Blast Accessory into the inside of it. Pull the Pad over the edges of Accessory until it fits snugly.
- 2 Attach the Scrub Blast Accessory by connecting it to the Direct Steam Nozzle until it clicks into place.
- 3 When you press the Steam Control Button Accessory Mode (**ACCESSORY**) will automatically be selected and you can begin cleaning (**LO** and **HI** Settings are not available for above-floor cleaning). Steam will blast from the front tip of the Accessory—press the Accessory against the surface you wish to clean, and the steam will redirect into the Pad. Continue to press the Accessory down as you clean.
- 4 To remove the Scrub Blast Accessory, squeeze the Accessory Release Buttons, then slide out the Accessory.

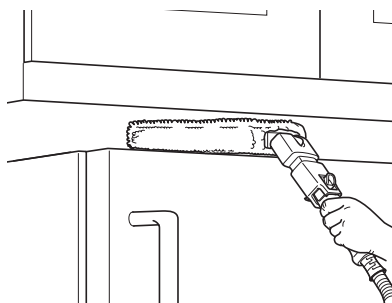

USING THE EZ REACH BENDING DUSTER ACCESSORY

Cleaning Tip: The EZ Reach Bending Duster Accessory is ideal for dusting a variety of surfaces, especially hard-to-reach ones.

CAUTION: Make sure the Steam Mop is unplugged or in Standby Mode while attaching or removing the EZ Reach Bending Duster Accessory. Avoid touching the Accessory, as it will be very hot after steaming.

CAUTION: To avoid scalding injuries, always unplug and allow the Steam Mop to cool before removing or changing Accessories or Cleaning Pads.

CAUTION: Make sure ceiling fans are off before cleaning/dusting them.

- 1 Slide the EZ Reach Bending Duster Pad all the way up the EZ Reach Bending Duster Accessory so it fits snugly.
- 2 Cinch the elastic band and slide the locking toggle to tighten.
- 3 Attach the EZ **Reach** Bending Duster Accessory by connecting it to the Direct Steam Nozzle until it clicks into place.
- 4 When you press the Steam Control Button Accessory Mode (**ACC**) will automatically be selected and you can begin cleaning (**LO** and **HI** Settings are not available for above-floor cleaning).
- 5 To bend the accessory into the desired position, pull back on the buttons on the sides of the EZ Reach Bending Duster Accessory.
- 6 To remove the EZ Reach Bending Duster Accessory, squeeze the Accessory Release Buttons, then slide out the Accessory.

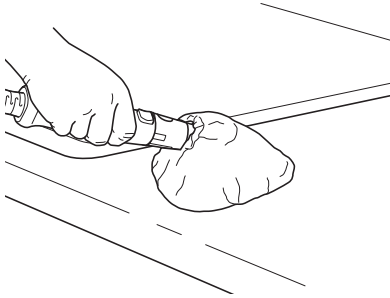

USING THE FLAT SCRUBBER ACCESSORY

Cleaning Tip: The Flat Scrubber Accessory is ideal for a variety of surfaces. Its design allows you to apply more force when scrubbing.

⚠ CAUTION: Make sure the Steam Mop is unplugged or in Standby Mode while attaching or removing the Flat Scrubber Accessory. Avoid touching the Accessory, as it will be very hot after steaming.

⚠ CAUTION: To avoid scalding injuries, always unplug and allow the Steam Mop to cool before removing or changing Accessories or Cleaning Pads.

⚠ CAUTION: Do not use on wallpaper.

- 1** To attach the Flat Scrubber Pad, place it exterior side down on a flat surface, then set the Flat Scrubber Accessory into the inside of it. Pull the Pad over the edges of Accessory until it fits snugly.
- 2** Attach the Flat Scrubber Accessory by connecting it to the Direct Steam Nozzle until it clicks into place.
- 3** When you press the Steam Control Button Accessory Mode (**ACCESSORY**) will automatically be selected and you can begin cleaning (**LO** and **HI** Settings are not available for above-floor cleaning).
- 4** To remove the Flat Scrubber Accessory, squeeze the Accessory Release Buttons, then slide out the Accessory.

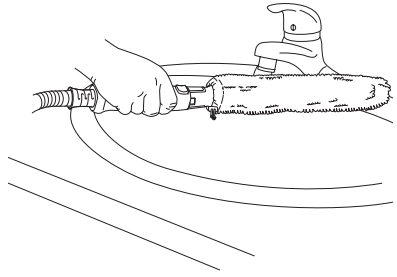

USING THE STEAM DUSTER ACCESSORY

Cleaning Tip: The Steam Duster Accessory is ideal for cleaning and dusting a variety of surfaces, like large areas, hard-to-reach places, and crevices.

⚠ CAUTION: Make sure the Steam Mop is unplugged or in Standby Mode while attaching or removing the Steam Duster Accessory. Avoid touching the Accessory, as it will be very hot after steaming.

⚠ CAUTION: To avoid scalding injuries, always unplug and allow the Steam Mop to cool before removing or changing Accessories or Cleaning Pads.

- 1** Slide the Steam Duster Pad all the way up the Steam Duster Accessory so it fits snugly.
- 2** Cinch the elastic band and slide the locking toggle to tighten.
- 3** Attach the Steam Duster Accessory by connecting it to the Direct Steam Nozzle until it clicks into place.
- 4** When you press the Steam Control Button Accessory Mode (**ACCESSORY**) will automatically be selected and you can begin cleaning (**LO** and **HI** Settings are not available for above-floor cleaning).
- 5** To remove the Steam Duster Accessory, squeeze the Accessory Release Buttons, then slide out the Accessory.

Caring for Your Steam Mop

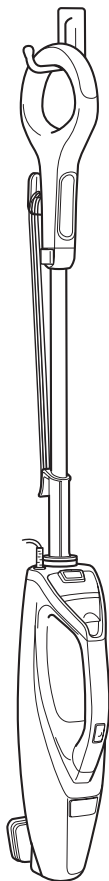

fig. 13

AFTER USE AND STORAGE

- 1 Press the Steam Control Button until the Steam Mop returns to Standby Mode. Unplug the cord from the outlet and place the Steam Mop into the upright position. Let it cool.
- 2 If you have been using the Handheld Steamer, reattach it to the Mop Handle.
- 3 Remove the Pocket Pad from the Mop Head by undoing the hook-and-loop closure and using the loop on the side to pull it off the Mop Head, avoiding contact with the hot Pocket Pad.
- 4 Empty the Water Tank before storing. Open the Water Tank Cap and empty the Tank in a sink. Close the Cap.
- 5 To store the Steam Mop hanging up, first remove the Mop Head (after it has cooled and the steam has been released), then hang on a large hook (not included) (**fig. 13**).

Caring for Your Steam Mop - continued

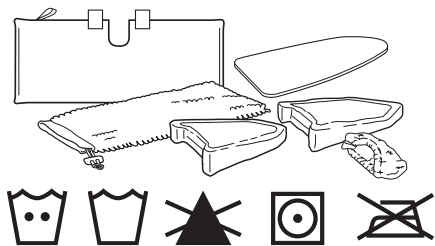

fig. 14



fig. 15

POCKET PAD CARE INSTRUCTIONS

Care

Before washing, close the hook-and-loop fasteners so they won't snag on the Pocket Pads. Machine wash the Pocket Pads separately with warm water using liquid detergent.

NEVER USE BLEACH, POWDERED DETERGENT, OR FABRIC SOFTENERS as they may damage or leave a coating on the Pocket Pads that will reduce their cleaning performance and absorbency. Pocket Pads should be line-dried or tumble-dried on a low setting, as this will extend the life of the microfiber fabric (**fig. 14**).

Loose fibers can indicate wearing of the microfiber fabric. Do not pull the loose fibers as this can cause the weave to come undone. Simply trim the loose fibers with scissors (**fig. 15**).

Replacement Pocket Pads

For best cleaning results, we recommend replacing your Pocket Pads every 3 to 4 months following normal use. As with any fabric, dirt particles, grease, friction, and repeated washing can cause the fibers to break down, and you may notice an increase in the effort needed to push or pull the Steam Mop.

You can purchase replacement Pocket Pads and Accessories by visiting www.sharkclean.com or calling 1-800-798-7398.



STEAM NOZZLE CARE

If you believe the Steam Nozzle or the Direct Steam Nozzle is clogged, please contact Customer Service at 1-800-798-7398 or consumer-services@euro-pro.com.

Ordering Optional Accessories

NOTE: Select Accessories are included. Others are available for purchase at www.sharkclean.com or by calling 1-800-798-7398.

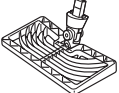
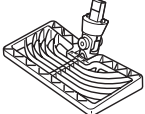
For a list of what is included with this model, refer to inside flap of box.

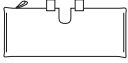
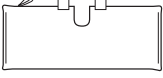
| ACCESSORY | |
|--|--|
| Triangle Mop Head For cleaning corners and hard-to-reach areas (not for sanitization). |  101SC4601 |
| Rectangle Mop Head For all-purpose cleaning. |  102SC4601 |
| XL Mop Head For large-area cleaning (not for sanitization). |  100SC4601 |
| Triangle Washable All-Purpose Scrub Pocket Pad One side features scrubbing strips to help remove tough, dried-on stains; the other features shaggy fingers to lift and lock in dust and dirt. |  P179W |
| Rectangle Washable All-Purpose Scrub Pocket Pad One side features scrubbing strips to help remove tough, dried-on stains; the other features shaggy fingers to lift and lock in dust and dirt. |  P139W |
| XL Rectangle All-Purpose Pocket Pad Shaggy fingers on both sides lift and lock in dust and dirt. |  P180W |

ACCESSORY

Scrub Blast Pad

Quilted microfiber deep-cleans hard-to-clean surfaces.



P168W

Total Clean Pocket Pad

One side features a scrubber to help remove stuck-on messes; the other features quilted microfiber to lift and lock in dust and dirt.



P173W

Precision Clean Pocket Pad

One side features a scrubber to help remove stuck-on messes; the other features quilted microfiber to lift and lock in dust and dirt.



P171W

EZ Reach Bending Duster Pad & Steam Duster Pad

Extra-large shaggy fingers on both sides lift and lock in dust and dirt.



P170W

Flat Scrubber Pad

Shaggy fingers lift and lock in dust and dirt.



P123W

Stain Blast Scrubber Pad

Breaks apart tough, dried-on stains fast.



P176W

Troubleshooting Guide

| PROBLEM | POSSIBLE REASONS & SOLUTIONS |
|---|--|
| The Steam Mop isn't producing any steam. | <p>The Steam Mop should be securely plugged into an electrical outlet. Check your fuse or circuit breaker or try a different outlet.</p> <p>Make sure the Water Tank is full, the unit is plugged in, and the light around the Steam Control Button is solid.</p> <p>If the light around the Steam Control Button is not lit, try a different electrical outlet.</p> <p>If the light around the Steam Control Button is blinking, press the Steam Control Button to select a Steam Setting.</p> <p>If the light around the Steam Control Button is solid, wait 30 seconds for the unit to warm up.</p> <p>If after following the above steps the Steam Mop still does not produce any steam, contact Customer Service at 1-800-798-7398 or consumer-services@euro-pro.com.</p> |
| The Steam Mop is producing intermittent steam. | <p>This is normal—for more consistent steam select the HI Setting.</p> <p>Also make sure the Water Tank is full.</p> |
| I can't select a Steam Setting. | <p>Make sure the Steam Mop is plugged in and the light around the Steam Control Button is solid.</p> <p>If your Steam Mop is producing steam but the light around the Steam Control Button is not lit, call customer service at 1-800-798-7398</p> |
| I am getting streaky/cloudy floors. | <p>The Pocket Pad might be dirty. If it is, flip it over to the clean side or change it entirely. If you washed the Pocket Pad with powdered detergent, then it could be damaged and require replacement.</p> <p>This could also be an indication of soap or grease residue that has accumulated on the floor. As our Steam Mops use only a small amount of water, it may not be enough to rinse off the accumulation of residue that the steam is bringing to the surface. We suggest rinsing the floor with nothing but water, letting it dry, and then steam mopping again with a clean Pocket Pad. One or more rinses will generally remove the residue.</p> <p>A more stubborn case may require you to rinse the floor with a mix of one part vinegar and two parts water* (but DO NOT put vinegar or any other cleaner into the Steam Mop's Water Tank).</p> <p>*Please consult your flooring manufacturer's care and maintenance instructions before applying any cleaning products or solutions including vinegar.</p> |

| PROBLEM | POSSIBLE REASONS & SOLUTIONS |
|---|--|
| <p>My unit stopped steaming in Above-Floor Mode.</p> | <p>First, check that the unit is plugged in and the ACCESSORY Setting is selected.</p> <p>Make sure the Steam Nozzle is not facing upward (see page 10). Make sure the Accessory Hose is firmly secured to the Main Unit and the Accessory is firmly secured to the Accessory Hose.</p> <p>NOTE: The Accessory Hose should attach to the Main Unit with the Hose Release Button facing the top/front of the Main Unit. See Page 11.</p> <p>If the problem persists, unplug the Steam Mop and check the water level. Add water if needed.</p> <p>If you continue to experience a problem, please contact Customer Service at 1-800-798-7398 or consumer-services@euro-pro.com.</p> |

Frequently Asked Questions

| QUESTION | ANSWER |
|---|--|
| How do I deploy the Stain Scrubber? | To deploy the Stain Scrubber, slide the Engage Scrubber/Release Head Button all the way down until you hear a click. The Stain Scrubber will automatically pop into position. Lift the Mop Body off the Mop Head and place it on the floor to start scrubbing. |
| How do I retract the Stain Scrubber? | Re-dock the Mop Body onto the Mop Head and the Stain Scrubber will automatically retract. |
| Is the Stain Scrubber going to damage my floors? | The Stain Scrubber is designed to be safe on all sealed floors, but it is always recommended to test an isolated area of the surface to be cleaned before proceeding. |
| What surfaces can I use the Steam Mop on? | <p>The Steam Mop is designed for use on all sealed hard-floor surfaces. We recommend that you first test an isolated area of the floor surface to be cleaned as well as review the use and care instructions from your floor manufacturer.</p> <p>⚠ WARNING: Do not use on leather, wax-polished furniture, synthetic fabrics, velvet, or other delicate, steam-sensitive materials.</p> <p>NOTE: On surfaces treated with wax and on some no-wax floors, the sheen may be removed by the heat or steam action of the unit. Test an isolated area of flooring first to see if sheen is affected.</p> |
| Can I put something other than water in the Water Tank of the Steam Mop? | DO NOT add cleaning solutions, scented perfumes, oils, or any other chemicals to the water used in this appliance as this may damage the unit or make it unsafe for use. We recommend using distilled water in your Steam Mop. |
| How do I convert to the Handheld Steamer for Above-Floor Cleaning? | Remove the Mop Handle by pressing and holding down the Handle Release Button while pulling the Mop Handle out of the Mop Body. Press down the Engage Scrubber/Release Head Button and lift the unit off the Mop Head. Attach the Accessory Hose by snapping it into the Steam Nozzle of the Handheld Steamer. |
| Can I steam soft surfaces and fabrics with the Above-Floor Accessories? | No, Above-Floor Accessories are designed to clean hard surfaces only. |
| Which Steam Setting should I use with the Above-Floor Accessories? | Once you transition to the Handheld Steamer, the unit will only be able to select the ACCESSORY Setting. You will not be able to select the LO or HI Settings. |



ONE (1) YEAR LIMITED WARRANTY

EURO-PRO Operating LLC warrants this product to be free from defects in material and workmanship for a period of one (1) year from the date of the original purchase, when utilized for normal household use, subject to the following conditions, exclusions, and exceptions.

If your appliance fails to operate properly while in use under normal household conditions within the warranty period, return the complete appliance and accessories, freight prepaid. For assistance with warranty service options or customer support, please call Customer Service at 1-800-798-7398 or visit www.sharkclean.com.

If the appliance is found to be defective in material or workmanship, **EURO-PRO Operating LLC** will repair or replace it free of charge. Proof of purchase is required and a fee of \$19.95 will apply to cover the cost of return freight.*

The liability of **EURO-PRO Operating LLC** is limited solely to the cost of the repair or replacement of the unit at our option. This warranty does not cover normal wear of parts and does not apply to any unit that has been tampered with or used for commercial purposes. This limited warranty does not cover damage caused by misuse, abuse, negligent handling, or damage due to faulty packaging or mishandling in transit. This warranty does not cover damage or defects caused by or resulting from damages from shipping or repairs, service, or alterations to the product or any of its parts that have been performed by a repair person not authorized by **EURO-PRO Operating LLC**.

This warranty is extended to the original purchaser of the unit and excludes all other legal and/or conventional warranties. The responsibility of **EURO-PRO Operating LLC** warranty if any, is limited to the specific obligations expressly assumed by it under the terms of the limited warranty. In no event is **EURO-PRO Operating LLC** liable for incidental or consequential damages of any nature whatsoever. Some states/provinces do not permit the exclusion or limitation of incidental or consequential damages, so the above may not apply to you.

This warranty gives you specific legal rights, and you may also have other rights which vary from state to state or province to province.

***Important: Carefully pack item to avoid damage in shipping. Be sure to include proof of purchase date and to attach tag to item before packing with your name, complete address, and phone number with a note giving purchase information, model number, and what you believe is the problem with the item. We recommend you insure the package (as damage in shipping is not covered by your warranty). Mark the outside of your package "ATTENTION CUSTOMER SERVICE".**

Product Registration

Please visit www.sharkclean.com or call **1-800-798-7398** to register your new Shark® product within ten (10) days of purchase. You will be asked to provide the store name, date of purchase, and model number, along with your name and address.

The registration will enable us to contact you in the unlikely event of a product safety notification. By registering, you acknowledge you have read and understood the instructions for use and the accompanying warnings set forth in the instructions.

Questions or Problems?

CALL US.
We are here to
help with our
hassle-free
return service.

Toll-Free Customer Support Telephone:

Mon-Sat: 7am-11pm, Sun: 9am-8pm EST

1-800-798-7398

 consumer-services@euro-pro.com

EURO-PRO Operating LLC

U.S.: Newton, MA 02459

Canada: Ville St. Laurent, Québec H4S 1A7

1-800-798-7398

www.sharkclean.com

COPYRIGHT © 2015 EURO-PRO OPERATING LLC

Euro-Pro, Shark and Steam Pocket are registered trademarks of Euro-Pro Operating LLC.

SH70_31_B_E_1507/0_1

PRINTED IN CHINA. Illustrations may differ from actual product. We are constantly striving to improve our products,

therefore the specifications contained herein are subject to change without notice.

For Shark (Ninja) U.S. Patent information, visit <http://www.europro.com/USPatents>