

# OWNER'S MANUAL

## 3-4 and 4-5 Person Cedar Elite Premium Saunas



**Please Do Not Hesitate to  
Contact Our Consumer Hotline  
at 800-759-0977  
with Any Questions That May  
Arise During Assembly or  
Use of This Product!**

# TABLE OF CONTENTS

|                          |       |
|--------------------------|-------|
| ASSEMBLY TIPS & WARNINGS | 3     |
| PARTS IDENTIFIER         | 4     |
| ASSEMBLY INSTRUCTIONS    | 5-9   |
| OPERATION INSTRUCTIONS   | 10    |
| ENJOYING YOUR SAUNA      | 11    |
| HEALTH & SAFETY WARNINGS | 12    |
| CLEANING & MAINTANENCE   | 13    |
| TROUBLESHOOTING GUIDE    | 13-14 |
| REPLACEMENT PARTS        | 15-17 |
| WARRANTY INFORMATION     | 18    |

*If you would like a French version of this manual, please contact our Customer Service Department at 800-759-0977 or [custserv@splashnetxpress.com](mailto:custserv@splashnetxpress.com)*

*Si vous voulez une version française d'un manuel, s'il vous plaît contacter notre service à la clientèle au 800-759-0977 ou [custserv@splashnetxpress.com](mailto:custserv@splashnetxpress.com)*

*The information contained in this manual is subject to change without notice.*

## ASSEMBLY TIPS & WARNINGS

- Before you begin, read all assembly instructions and safety warnings carefully.
- This sauna requires at least 2 adults to complete assembly.

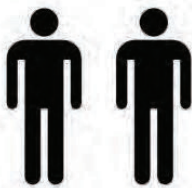

- Remove all of the contents from boxes and verify that you have all of the parts shown on the Parts Identifier before you begin assembly. *Note: Some parts may be pre-installed or pre-assembled.*
- This manual is used for the assembly of several sauna models; therefore, some figures or drawings may not look exactly like your product.
- Cover the sauna floor during assembly to avoid staining the unfinished wood surface.
- Retain this Owner's Manual for future reference.

### ELECTRICAL REQUIREMENTS

- We recommend consulting a licensed electrician and checking local ordinances before installing ANY sauna.
- These saunas require a 20 amp receptacle and a 20 amp circuit breaker. *Note: Electrical modifications may be required to accommodate 20 amp power.*

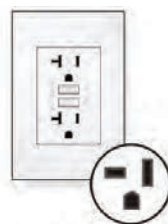













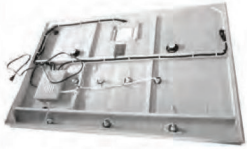





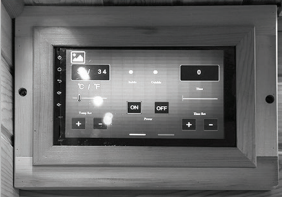

- Refer to the serial plate on the back of the sauna for complete electrical specifications.
- ***These saunas requires a dedicated circuit - No other appliances should share the same outlet with the sauna.***

### CHOOSING A LOCATION

- This sauna should only be placed INDOORS on a dry, level surface.
- There should be a minimum of 5 inches clearance between the sauna and any wall.
- Make sure the main power cord will reach the outlet and remains easy to access.
- The sauna should only be used in a dry location as moisture will damage the wood and electrical components.
- Keep the sauna away from any potential hazards including water sources, flammable objects and combustible materials.

# PARTS IDENTIFIER (NOT TO SCALE)

|                                                                                                                                                           |                                                                                                                           |                                                                                                                                                        |                                                                                                                               |                                                                                                                       |
|-----------------------------------------------------------------------------------------------------------------------------------------------------------|---------------------------------------------------------------------------------------------------------------------------|--------------------------------------------------------------------------------------------------------------------------------------------------------|-------------------------------------------------------------------------------------------------------------------------------|-----------------------------------------------------------------------------------------------------------------------|
| <br><b>FRONT PANEL WITH GLASS DOOR</b>                                   | <br><b>LEFT PANEL</b>                    | <br><b>RIGHT PANEL</b>                                                | <br><b>BACK PANEL</b>                      | <br><b>ROOF</b>                    |
| <br><b>ROOF COVER</b>                                                    | <br><b>FLOOR</b>                         | <br><b>BENCH SUPPORT</b>                                              | <br><b>BENCH SEAT</b>                      | <br><b>BENCH HEATER PANEL</b>      |
| <br><b>BACKREST</b>                                                     | <br><b>DOOR HANDLE</b>                  | <br><b>TOWEL HOOK</b>                                                | <br><b>CONTROL PANEL WITH FRAME</b>        | <br><b>MOOD LIGHTING REMOTE</b>   |
| <br><b>OXYGEN IONIZER</b>                                              | <br><b>2" (50mm) SCREW<sup>2</sup></b> | <br><b>1-1/8" (30mm) SCREW<sup>2</sup></b>                          | <br><b>3/4" (20mm) SCREW<sup>2</sup></b> | <sup>2</sup> Extra hardware is included - It is normal to have extra screws leftover when sauna assembly is complete. |
| ADDITIONAL EQUIPMENT REQUIRED:<br><br><b>PHILLIPS HEAD SCREWDRIVER</b> | <br><b>STEP LADDER</b>                 | <b><i>This manual is used for the assembly of several sauna models; therefore, some images or drawings may not look exactly like your product.</i></b> |                                                                                                                               |                                                                                                                       |

Refer to REPLACEMENT PARTS (PAGE 15-17) to determine the correct part number when ordering replacements.

# ASSEMBLY INSTRUCTIONS

1. Begin assembly by determining an appropriate location for your sauna – see ASSEMBLY TIPS & WARNINGS for details. Place the FLOOR PANEL on the floor in this location.



2. Place the BACK PANEL on the FLOOR PANEL, lining up the BACK PANEL against the floor trim piece on the backside of the FLOOR.



3. Place the RIGHT PANEL on the FLOOR in the same manner and buckle it to the BACK PANEL.

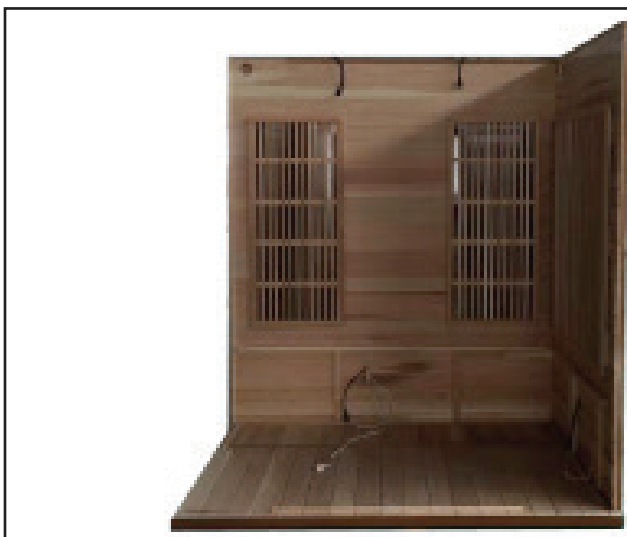

*NOTE: make sure all panels fit together snugly, with side wall end fitting in groove and outer trim overlapping wall, when buckling panels.*



## ASSEMBLY INSTRUCTIONS (CONT.)

4. Place the LEFT PANEL on the FLOOR in the same manner and buckle it to the BACK PANEL.

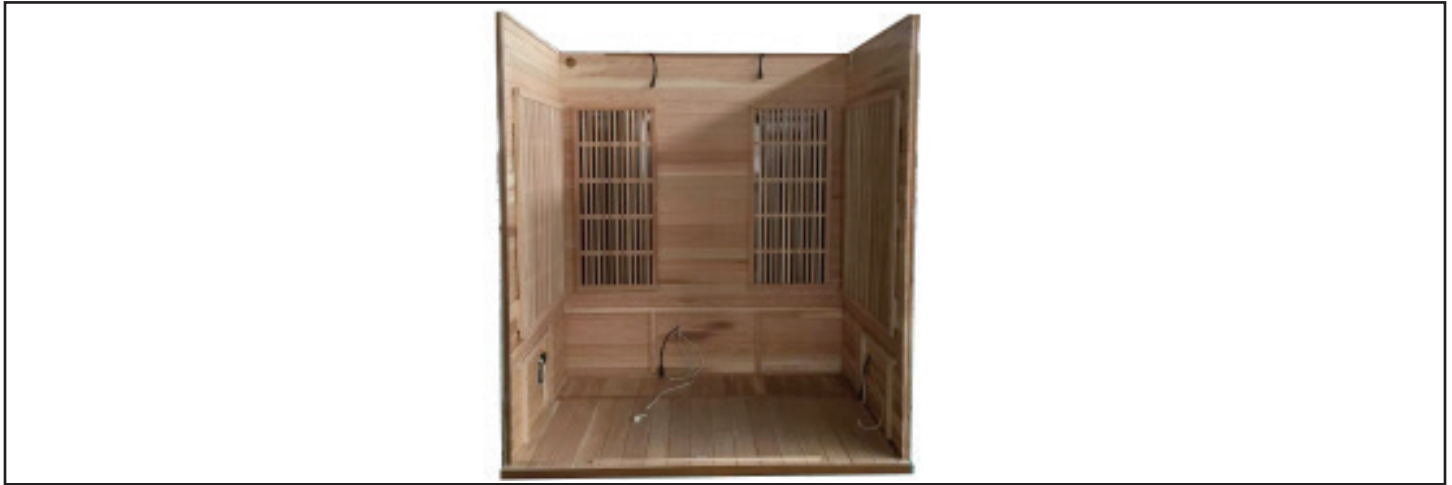

5. Slide the BENCH SUPPORT HEATER PANEL (LONG) into place between the two SIDE PANELS. Connect the heater plug. *Note: It may be necessary to move a side wall out slightly to do this.*



6. Place the two BENCH SUPPORT HEATER PANELS (SHORT) into place, one on each side, against the back SUPPORT HEATER PANEL. Connect the heater plugs.



## ASSEMBLY INSTRUCTIONS (CONT.)

7. Attach two FRONT SIDE BENCH SUPPORTS to BENCH SUPPORT HEATER PANELS (SHORT) with 2" SCREWS. Attach each BENCH SEAT with 2" SCREWS.

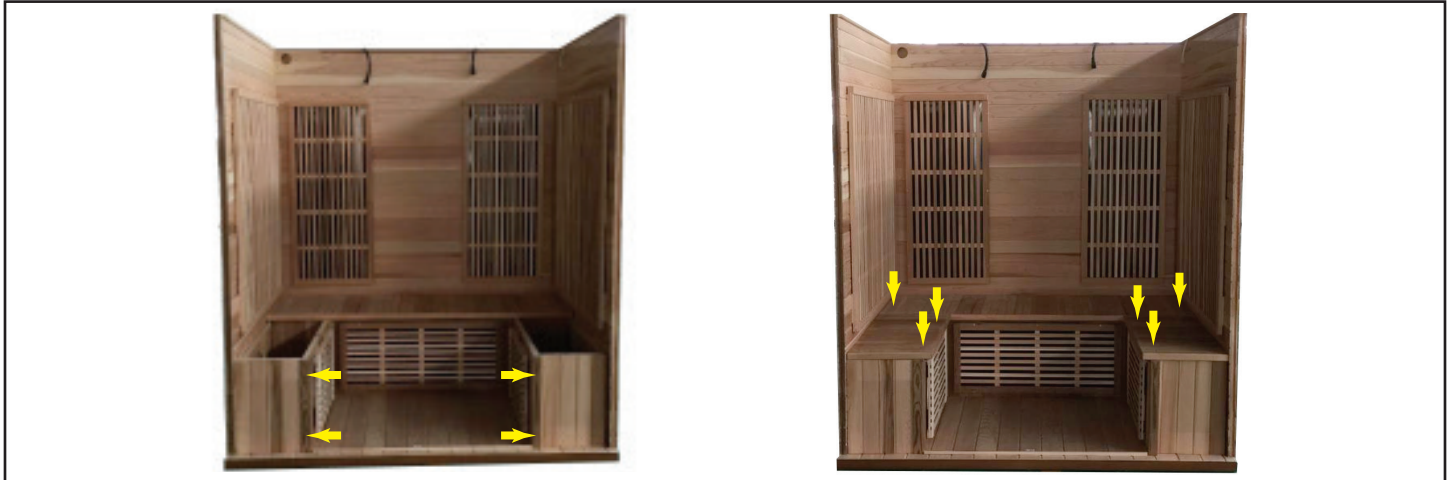

8. Place the FRONT PANEL on front lip of the FLOOR and buckle it to the SIDE PANELS.



9. Lift the ROOF above the sauna, feeding the control panel and heater cables through the corresponding holes. Secure the ROOF to the sauna with 1-1/8" SCREWS. Connect the control panel wires, antenna, color therapy light and heater plugs.



## ASSEMBLY INSTRUCTIONS (CONT.)

10. Feed the main power cable through hole in ROOF and plug securely into receptacle on back of POWER SUPPLY box. Secure the ROOF COVER with 3/4" SCREWS.

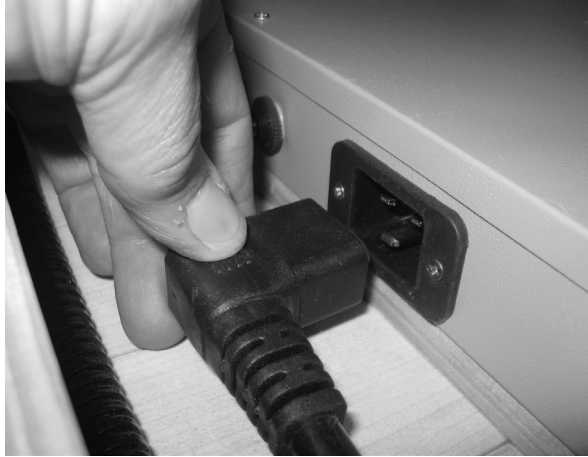

11. Connect touch screen control panel as shown and mount frame to BACK PANEL with 2" SCREWS.



12. Attach the DOOR HANDLE to the GLASS DOOR by assembling parts (A) as shown (for top and bottom of handle), then inserting set screws (B) into handle and screwing into fitting (C).

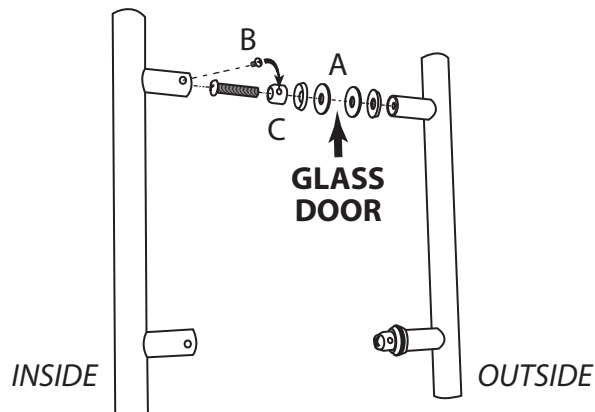

## ASSEMBLY INSTRUCTIONS (CONT.)

13. Remove the back cover of the OXYGEN IONIZER by turning it as indicated. Unwrap and install the fragrance patch, then reattach the back cover. Attach the OXYGEN IONIZER in the designated position with 3/4" SCREWS. Plug the power cable into the OXYGEN IONIZER.



14. Attach the DOUBLE TOWEL HOOK with 3/4" SCREWS. *Note: attaching hook is optional, but if you do, consider the position carefully before driving any screws into the sauna interior.*

15. Plug the main power cable into a dedicated outlet. *Note: No other appliances should share the same outlet with this sauna.*

## CONGRATULATIONS!

The assembly of your sauna is now complete.

Please review the Operation Instructions and Health & Safety warnings before using your sauna.

To ensure years of trouble-free use, follow the Cleaning & Maintenance guidelines carefully.

# OPERATION INSTRUCTIONS

## SAUNA CONTROL PANEL - MAIN SCREEN

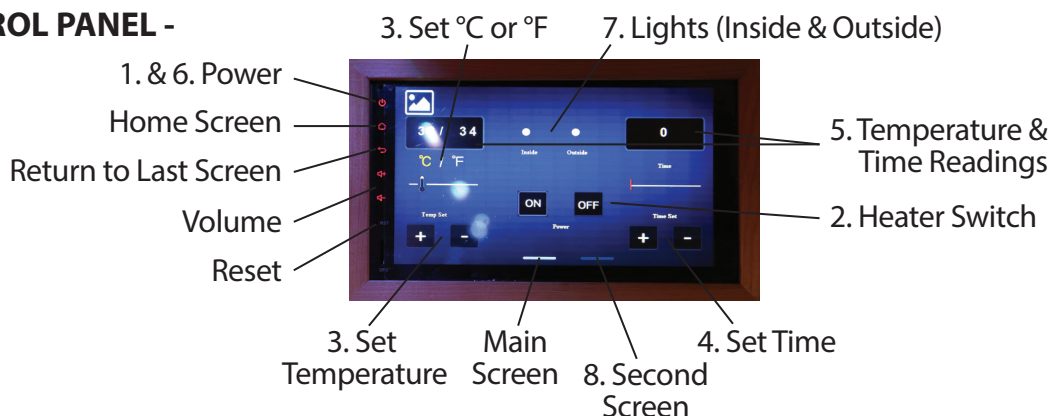

1. Press POWER to turn ON Control Panel. This will open Main Screen.
2. Press center Heater Switch to turn Sauna Heater Panels ON or OFF .
3. Select °C or °F and set the desired TEMPERATURE with the (+) and (-) buttons.
4. Set the desired TIME with the (+) and (-) buttons.
5. When the TIME reaches 00, the heaters will turn OFF automatically.
6. After your sauna session, press POWER to turn OFF the sauna.
7. Press INSIDE or OUTSIDE to turn ON or OFF the corresponding light.
8. Use bottom right button to get to SECOND SCREEN for music and color therapy light controls.

## SECONDARY SCREEN - Use button to select function

### COLOR THERAPY CONTROL PANEL

(use LED COLOR button to reach controls)

1. Press ON or OFF in top white bar.
2. Press cycled color, or individual color desired, using color buttons.
3. Use dimer switch to control brightness.
4. Cycle switch can be used to go through colors and select.

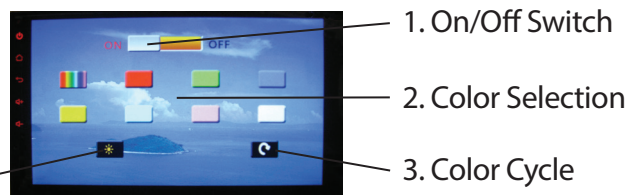

**TUNER** - Use buttons to select AM and FM radio signal (FM1, FM2, FM3, AM1 or AM2), scroll through channels (<>), or auto seek (AMS). Channels can be saved in P1- P6.

**BLUETOOTH** - Use touch controls to select and play music.

**CALENDAR** - Use arrow buttons on right side of screen to set date and time, then press SAVE.

## INTERIOR MOOD LIGHTING

1. Use the remote control to make adjustments to interior light color and intensity.

## OXYGEN IONIZER

1. Press ION to release negatively charged ions to purify the air.
2. Press O3 to disinfect the air with ozone.



## ENJOYING YOUR SAUNA

1. Prior to initial use, wipe down all interior surfaces of the sauna with a damp cloth.
2. Turn on the sauna and set temperature to 104° F for one hour to burn off any factory dust.
3. Always drink plenty of water before, during and after your sauna session to stay properly hydrated.
4. A normal sauna session should last 30 minutes or less.
5. Allow approximately 15 to 25 minutes for the sauna to warm up before entering.
6. Perspiration will begin within 15 to 25 minutes after entering the sauna.
7. Limit the use of lotions or oils on your body while using your sauna. These products can block your pores and limit perspiration, decreasing the effectiveness of your sauna session.
8. For spot treatment of a particular area, position that body part closer to the heater, allowing for deeper heating in that area.
9. During your sauna session, place towels on the bench seats and on the floor to absorb perspiration and maintain the cleanliness of your sauna.
10. Towel off excess perspiration during your sauna session to help your body perspire more freely.
11. Open the ceiling vent or the front door to allow fresh air into your sauna.
12. Allow your body to cool down following your sauna session, then rinse the perspiration off your body in a warm shower.

## HEALTH & SAFETY WARNINGS

1. Review all instructions and warnings before operating your sauna. A sauna is not a toy. Serious injury may result from negligence, intentional misuse and failure to follow safety instructions.
2. **Hyperthermia Danger:** Hyperthermia occurs when the body absorbs more heat than it can dissipate. When the elevated body temperatures are sufficiently high, hyperthermia is a medical emergency and requires immediate treatment to prevent disability or death. It is very important not to allow your body's core temperature to rise above 103° F. Symptoms of hyperthermia include dizziness, lethargy, drowsiness and fainting. The effects of hyperthermia may include failure to perceive heat, failure to recognize the need to exit the sauna, unawareness of the impending health hazard, physical inability to exit the sauna and unconsciousness.
3. If you are feeling uncomfortable, faint or dizzy, exit the sauna immediately.
4. Do not exceed recommended time and temperature guidelines.
5. Do not touch or interfere with the temperature sensor on the control panel.
6. Do not touch or spray water on the heater elements.
7. Do not use the sauna while under the influence of drugs or alcohol.
8. Do not sleep inside the sauna.
9. Do not use the sauna immediately following strenuous exercise. Allow your body to cool down for 30 minutes before entering the sauna.
10. Pets should never be placed in the sauna.
11. Pregnant women, children under the age of 6, the elderly and infirm should not use the sauna.
12. Children over the age of 6 should always be supervised by an adult.
13. People with health problems including open wounds, fever, sunburn or dehydration should not use the sauna.
14. People suffering from obesity or with a history of heart disease, low or high blood pressure, circulatory system problems or diabetes should consult a physician before using the sauna.
15. Consult a physician before using the sauna if you take any prescription medications.
16. Keep towels and combustible materials away from the heater elements.
17. Remove all towels and materials after your sauna session.
18. Never leave your sauna unattended while in use.
19. Always unplug the sauna and allow it to cool down before performing any cleaning or maintenance.
20. Always turn off and unplug the sauna when not in use.

## CLEANING & MAINTENANCE

1. Always unplug the sauna and allow it to cool down before performing any cleaning or maintenance.
2. Use furniture polish or furniture oil when cleaning the sauna exterior.
3. The sauna interior surfaces should only be wiped down with a damp cloth. Do NOT use chemicals, abrasive cleaners or solvents on the unfinished interior wood.
4. As with all natural wood products, variations in the color and the grain as well as irregularities such as knots and fine cracks may be present. These characteristics are a part of the natural beauty of the wood and should not be considered defective.

## TROUBLESHOOTING GUIDE

### WARNING!

- Always unplug the sauna and allow it to cool down before performing any maintenance.
- Repairs to the electrical components of the sauna should only be performed by a qualified service technician.
- Unauthorized repairs or alterations will void the manufacturer's warranty.

### Problem    THERE IS NO POWER TO THE SAUNA

- Solution**
1. Check that the Main Power Cable is plugged into the wall outlet.
  2. Check that the circuit breaker for the outlet has not tripped. If the breaker has tripped, check that the amperage of the breaker is appropriate for your sauna.
  3. Check all connections to the Power Supply Box.
  4. Check for damage to the Main Power Cable; replace, if necessary.
  5. Replace the Power Supply Box, if necessary.



### Problem    ONE HEATER DOES NOT WORK

- Solution**
1. Check that all the connections are tight.
  2. Replace the Heater Element.

### Problem    NONE OF THE HEATERS WORK

- Solution**
1. Check that all connections are tight.
  2. Replace the Heater Circuit Board, if necessary.

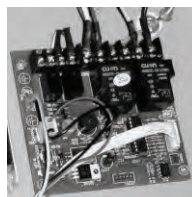

## TROUBLESHOOTING GUIDE (CONT.)

### **Problem** THE CONTROL PANEL DOES NOT WORK

1. Check that all the connections are tight.

**Solution** 2. Try resetting Control Panel by inserting a pin or paperclip end into the small hole next to RST on lower left.  
3. Try unplugging, wait a minute, and replugging power cord. If still not working, replace the Control Panel.

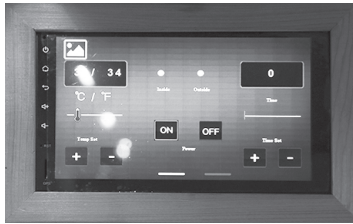

### **Problem** THE LIGHTS ARE NOT WORKING

1. Check that all the connections are tight.

**Solution** 2. If one light does not work, replace the bulb. *Note: Do not touch the glass part of the bulb with your fingers during installation.*  
3. If neither the lights nor the radio are working, replace the Power Supply Box.

### **Problem** THE SPEAKERS ARE NOT WORKING

1. Check that the volume is not turned all the way down and that the fader control is set correctly.

**Solution** 2. If only one speaker is working, check to see that the sound balance on the stereo is not set all the way to one side.  
3. Check that all the connections are tight.  
4. Replace the speaker, if necessary.

### **Problem** THE COLOR THERAPY LIGHTS ARE NOT WORKING

**Solution** 1. Check that all the connections are tight.  
2. Replace the Color Therapy Light, if necessary.

## REPLACEMENT PARTS

The following pages list part numbers specific to your particular sauna model. Please reference the model number at the top of each page to make sure you're using the correct list for your sauna. In the event that you need replacement parts, use these guides to reference the part number. It is important to use only replacement parts specified by the manufacturer. The use of unauthorized substitutes may damage your sauna or cause electrical hazards resulting in injury or fire, and will void the warranty.

# REPLACEMENT PARTS

Rev. 7/16

## SA1315 3 to 4-PERSON CEDAR ELITE SAUNA WITH CARBON HEATERS

| REF. # | DESCRIPTION                             | PART NUMBER | QTY.  |
|--------|-----------------------------------------|-------------|-------|
| 1      | FRONT PANEL with GLASS DOOR             | SAP2800     | 1     |
| 2      | BACK PANEL                              | SAP2801     | 1     |
| 3      | LEFT PANEL                              | SAP2802     | 1     |
| 4      | RIGHT PANEL                             | SAP2803     | 1     |
| 5      | BENCH SEAT (LONG)                       | SAP2804     | 1     |
| 6      | ROOF                                    | SAP2805     | 1     |
| 7      | FLOOR                                   | SAP2806     | 1     |
| 8,9    | 300W HEATER ELEMENT – BACK PANEL        | SAP2422     | 2     |
| 8,9    | 300W HEATER ELEMENT – LEFT PANEL        | SAP2422     | 2     |
| 8,9    | 300W HEATER ELEMENT – RIGHT PANEL       | SAP2422     | 2     |
| 10     | ROOF COVER                              | SAP2807     | 1     |
| 11     | BENCH SEAT (SHORT)                      | SAP2808     | 2     |
| 12     | 180W HEATER ELEMENT – BACK BENCH HEATER | SAP2419     | 1     |
| 13     | FRONT SIDE BENCH SUPPORT                | SAP2809     | 2     |
| 14     | BENCH SUPPORT HEATER PANEL (LONG)       | SAP2810     | 1     |
| 15     | THERMOSTAT WIRE                         | SAP25314    | 1     |
| 16     | TOWEL HOOK                              | SAP2811     | 1     |
| 17     | MAIN POWER CABLE                        | SAP2704     | 1     |
| 18     | DOOR HANDLE                             | SAP2812     | 1 SET |
| 19     | BENCH SUPPORT HEATER PANEL (SHORT)      | SAP2813     | 2     |
| 20     | OXYGEN IONIZER                          | SAP2409     | 1     |
| 21     | GLASS DOOR                              | SAP2814     | 1     |
| 21     | GLASS CLIP - METAL                      | SAP2537     | 2     |
| 21     | DOOR MAGNET                             | SAP25371    | 2     |
| 22     | COLOR THERAPY LIGHT                     | SAP2410     | 1     |
| 23     | DOOR HINGE                              | SAP24154    | 2     |
| 24     | EXTERIOR LIGHT BULB                     | SAP2825     | 5     |
| 24,31  | LIGHT HOUSING                           | SAP2606     | 6     |
| 25     | MOOD LIGHTING                           | SAP2815     | 1 SET |
| 26     | MOOD LIGHTING REMOTE                    | SAP2816     | 1     |
| 27     | VENTILATION COVER                       | SAP2817     | 1     |
| 28     | SPEAKER                                 | SAP2416     | 2     |
| 29     | POWER SUPPLY BOX                        | SAP24071    | 1     |
| 29     | POWER SUPPLY RECEPTACLE                 | SAP24073    | 1     |
| 29     | HEATER CIRCUIT BOARD                    | SAP2826     | 1     |
| 29     | 25 AMP OVERCURRENT PROTECTOR            | SAP2530     | 1     |
| 30     | BACKREST                                | SAP2818     | 1     |
| 31     | INTERIOR LIGHT BULB                     | SAP2404     | 1     |
| 32     | 2" (50mm) SCREW                         | SAP2411     | 12    |
| 32     | 1-1/8" (30mm) SCREW                     | SAP2411     | 6     |
| 32     | 3/4" (20mm) SCREW                       | SAP2411     | 20    |
| 33     | 125W HEATER ELEMENT – SIDE BENCH HEATER | SAP2819     | 2     |
| 34     | TOUCH SCREEN CONTROL PANEL FRAME        | SAP2820     | 1     |
| 35     | TOUCH SCREEN CONTROL PANEL              | SAP2821     | 1     |
| 36     | BUCKLE                                  | SAP2607     | 12    |
| 37     | WOODEN POWER CABLE COVER                | SAP3128     | 1     |
| 38     | COLOR THERAPY CONTROL PANEL WIRE        | SAP2532     | 1     |
| 38     | CONTROL PANEL WIRING HARNESS            | SAP2822     | 1     |
| 38     | CONTROL PANEL FUSE                      | SAP2823     | 1     |
| 38     | CIRCUIT BOARD TO POWER SUPPLY BOX WIRE  | SAP2824     | 1     |

Please see drawing on page 17 to assist in identifying parts.

# REPLACEMENT PARTS

Rev. 7/16

## SA1322 4 to 5-PERSON CEDAR ELITE SAUNA WITH CARBON HEATERS

| REF. # | DESCRIPTION                             | PART NUMBER | QTY.  |
|--------|-----------------------------------------|-------------|-------|
| 1      | FRONT PANEL with GLASS DOOR             | SAP2830     | 1     |
| 2      | BACK PANEL                              | SAP2831     | 1     |
| 3      | LEFT PANEL                              | SAP2832     | 1     |
| 4      | RIGHT PANEL                             | SAP2833     | 1     |
| 5      | BENCH SEAT (LONG)                       | SAP2834     | 1     |
| 6      | ROOF                                    | SAP2835     | 1     |
| 7      | FLOOR                                   | SAP2836     | 1     |
| 8,9    | 300W HEATER ELEMENT – BACK PANEL        | SAP2422     | 2     |
| 8,9    | 300W HEATER ELEMENT – LEFT PANEL        | SAP2422     | 2     |
| 8,9    | 300W HEATER ELEMENT – RIGHT PANEL       | SAP2422     | 2     |
| 10     | ROOF COVER                              | SAP2837     | 1     |
| 11     | BENCH SEAT (SHORT)                      | SAP2838     | 2     |
| 12     | 180W HEATER ELEMENT – BACK BENCH HEATER | SAP2419     | 1     |
| 13     | FRONT SIDE BENCH SUPPORT                | SAP2839     | 2     |
| 14     | BENCH SUPPORT HEATER PANEL (LONG)       | SAP2840     | 1     |
| 15     | THERMOSTAT WIRE                         | SAP25314    | 1     |
| 16     | TOWEL HOOK                              | SAP2811     | 1     |
| 17     | MAIN POWER CABLE                        | SAP2704     | 1     |
| 18     | DOOR HANDLE                             | SAP2812     | 1 SET |
| 19     | BENCH SUPPORT HEATER PANEL (SHORT)      | SAP2841     | 2     |
| 20     | OXYGEN IONIZER                          | SAP2409     | 1     |
| 21     | GLASS DOOR                              | SAP2814     | 1     |
| 21     | GLASS CLIP - METAL                      | SAP2537     | 2     |
| 21     | DOOR MAGNET                             | SAP25371    | 2     |
| 22     | COLOR THERAPY LIGHT                     | SAP2410     | 1     |
| 23     | DOOR HINGE                              | SAP24154    | 2     |
| 24     | EXTERIOR LIGHT BULB                     | SAP2825     | 5     |
| 24,31  | LIGHT HOUSING                           | SAP2606     | 6     |
| 25     | MOOD LIGHTING                           | SAP2815     | 1 SET |
| 26     | MOOD LIGHTING REMOTE                    | SAP2816     | 1     |
| 27     | VENTILATION COVER                       | SAP2817     | 1     |
| 28     | SPEAKER                                 | SAP2416     | 2     |
| 29     | POWER SUPPLY BOX                        | SAP24071    | 1     |
| 29     | POWER SUPPLY RECEPTACLE                 | SAP24073    | 1     |
| 29     | HEATER CIRCUIT BOARD                    | SAP2826     | 1     |
| 29     | 25 AMP OVERCURRENT PROTECTOR            | SAP2530     | 1     |
| 30     | BACKREST                                | SAP2818     | 1     |
| 31     | INTERIOR LIGHT BULB                     | SAP2404     | 1     |
| 32     | 2" (50mm) SCREW                         | SAP2411     | 12    |
| 32     | 1-1/8" (30mm) SCREW                     | SAP2411     | 6     |
| 32     | 3/4" (20mm) SCREW                       | SAP2411     | 20    |
| 33     | 125W HEATER ELEMENT – SIDE BENCH HEATER | SAP2819     | 2     |
| 34     | TOUCH SCREEN CONTROL PANEL FRAME        | SAP2820     | 1     |
| 35     | TOUCH SCREEN CONTROL PANEL              | SAP2821     | 1     |
| 36     | BUCKLE                                  | SAP2607     | 12    |
| 37     | WOODEN POWER CABLE COVER                | SAP3128     | 1     |
| 38     | COLOR THERAPY CONTROL PANEL WIRE        | SAP2532     | 1     |
| 38     | CONTROL PANEL WIRING HARNESS            | SAP2822     | 1     |
| 38     | CONTROL PANEL FUSE                      | SAP2823     | 1     |
| 38     | CIRCUIT BOARD TO POWER SUPPLY BOX WIRE  | SAP2824     | 1     |

Please see drawing on page 17 to assist in identifying parts.

# PARTS SCHEMATIC

Rev. 7/16

## SA1315 & SA1322

*This drawing is for illustrative purposes only. It will not match your sauna exactly, but will indicate location of similar parts. Illustrations are not to scale.*

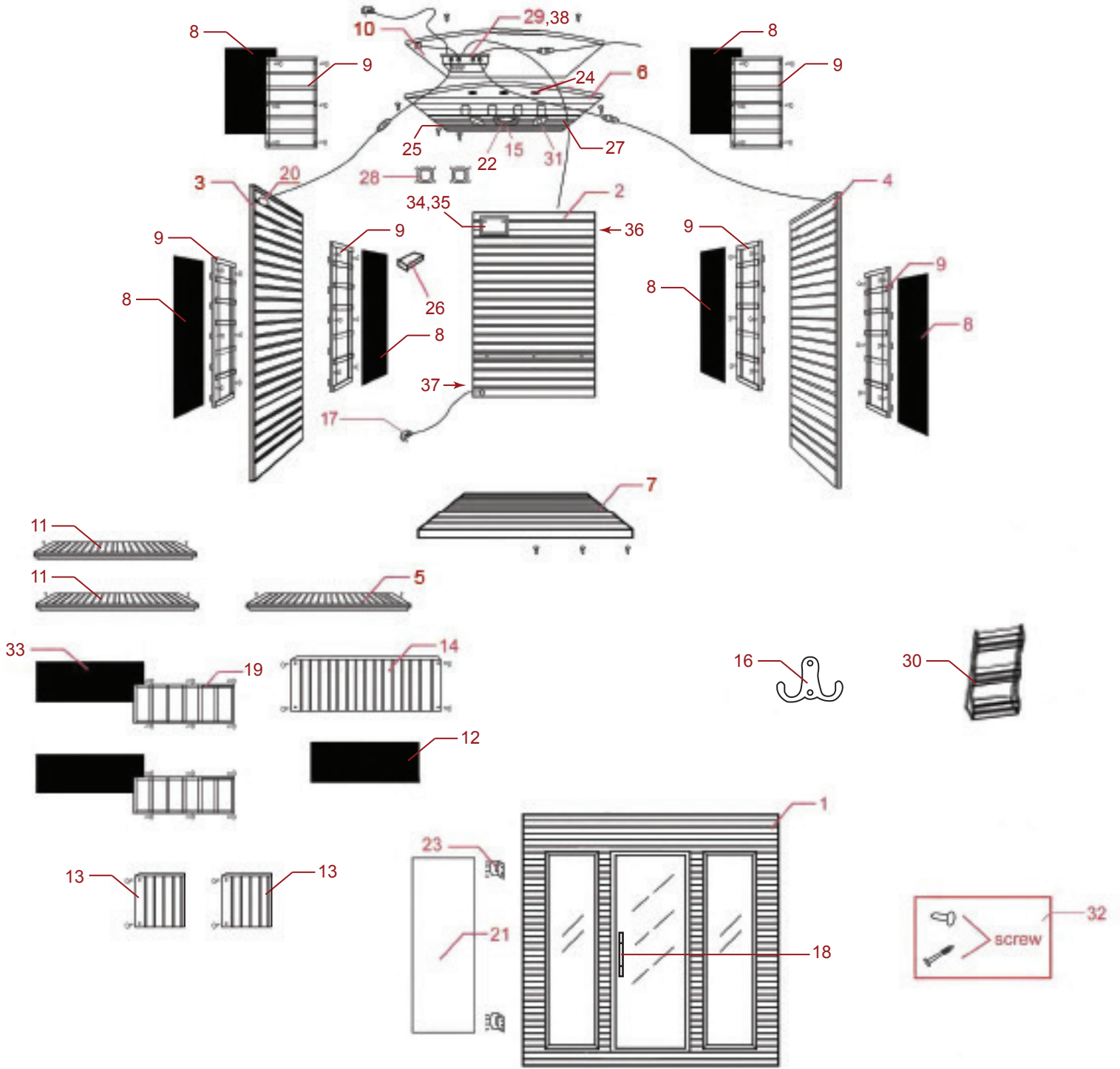

# SAUNA WARRANTY REGISTRATION CARD

1. This sauna has a 7-Year Limited Warranty against defects in materials and workmanship from date of purchase. To receive the warranty, the card below must be filled out completely and returned within thirty (30) days from date of purchase. This 7-Year Limited Warranty covers the wood structure\*. Heating elements and all electronics are covered by a 5-Year Limited Warranty. The radio/CD player (if included with your sauna) is covered by a limited 1-Year Warranty. The light bulbs are covered for 90 days.
2. This product is intended to be utilized for **private, non-commercial use**. Blue Wave Products sauna must be used as directed in the Product Operation Manual. Utilization of **non**-Blue Wave replacement parts or repairs which are not done by or under the direction of Blue Wave Products, Inc. shall also void any warranties/guarantees, expressed or implied.
3. This warranty does **not** cover defects or damage due to improper installation, alteration, accident, installation of unauthorized parts or any other event beyond the control of the Blue Wave Products. Defects or damage resulting from misuse, abuse or negligence will void this warranty. This warranty does **not** cover scratching or damage that may result from normal usage.
4. Please notify Blue Wave Products in advance of any sauna warranty claim prior to shipping the sauna back. Contact our warranty claim department at [warranty@splashnetxpress.com](mailto:warranty@splashnetxpress.com). This warranty becomes valid at time of purchase and terminates either by specified time frame listed above, owner transfer, or relocation.
5. This warranty is nontransferable and is expressly limited to the repair or replacement of the defective product. During the warranty period, Blue Wave Products shall repair or replace defective parts at no cost to the purchaser. Shipping charges and insurance are **not** covered and are the responsibility of the purchaser. Labor charges and related expenses for removal, installation or replacement of the product or components are **not** covered under this warranty.
6. If the warranty claim department determines that the item must be returned, it must be returned with freight prepaid and a receipt showing date of purchase, purchase price, and the dealer from which the sauna was purchased. **No warranty claim will be honored without a receipt.**
7. Warranty claims will only be resolved with the repair of the current product, or shipment of a replacement product or parts at the sole discretion of Blue Wave Products. NO REFUNDS will be given.
8. Blue Wave Products reserves the right to make substitutions to warranty claims if parts are unavailable or obsolete.
9. Blue Wave Products shall **not** be liable for loss of use of the product or other consequential or incidental costs, expenses or damages incurred by the consumer of any other use. The user assumes all risk of injury resulting from the use of this product.
10. Improper installation, misuse or damages resulting from acts of nature will render this warranty null and void.
11. This warranty is in lieu of all other warranties expressed or implied and no responsibility is assumed for future damage due to misuse. This sauna is intended for **INDOOR USE ONLY**– outdoor installation of the sauna **WILL VOID THE WARRANTY**. Additional actions that will void the warranty are: Use of lacquer or paints on any part of the sauna, placing sauna on non-approved surface, and outdoor applications.

*\*Surface cracks are NOT considered defects in material or workmanship, as they are normal characteristics of all wood. This includes minor cracks due to wood expansion and contraction. Note: since the wood used in construction has been kiln dried, a certain amount of expansion and contraction is expected in the wood within a sauna environment. Also, over time the sauna wood may darken or change color tones. This color change is considered normal aging and is not covered under warranty.*

To send in this warranty card:  
Fill out below, detach and mail  
to the following address:

**BLUE WAVE PRODUCTS**  
1745 Wallace Ave. Suite B  
St. Charles, IL 60174

For further warranty information  
or inquiries, please call 800-759-0977

Detach Here

Detach Here

## SAUNA WARRANTY REGISTRATION FORM

Date Purchased: \_\_\_\_/\_\_\_\_/\_\_\_\_

Name: \_\_\_\_\_

Address: \_\_\_\_\_

City/State/Zip: \_\_\_\_\_

Phone: (    ) \_\_\_\_\_ Email: \_\_\_\_\_

Purchased from: \_\_\_\_\_

Item Number: \_\_\_\_\_ Purchase Price: \_\_\_\_\_