

**SPORTCRAFT** 

**TABLE**  
**Games**

---

**96" Billiards Table**  
**244cm Mesa De Billar**

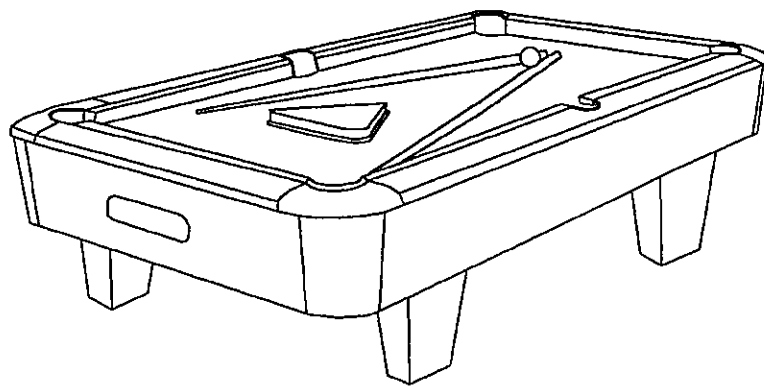

PLEASE CALL CUSTOMER SERVICE WITH  
ANY PART OR ASSEMBLY QUESTIONS.  
1-877-244-5466 9 TO 4 EST MONDAY - FRIDAY  
or via email at [customerservice@lionsportsinc.com](mailto:customerservice@lionsportsinc.com)

#64822 #64823  
#64824 #64825  
#64826



# **Congratulations for choosing Sportcraft Games!**

**This game has been manufactured from  
high quality materials for recreational purposes.**

## **CAUTION:**

**Please carefully read this manual  
and familiarize yourself with all the  
parts and contents before beginning  
assembly.**

## **WARNING:**

### **CHOKING HAZARD-**

**This Game Contains Small Parts**

### **SHARP OBJECTS -**

**This Game Contains Parts Which May Have Sharp Edges.  
Not Recommended for Children Under 8 Years of Age.**

## **Caring for Your Game Table:**

**Keep the table free from dust. To remove dust use a lightly dampened,  
lint free towel. Wipe from the center of the table surface to the edge  
of the table as you clean.**

**Do not put wet objects such as drinks on the playing surface  
or any other part of the table as it might cause damage to the table.**

**Do not store in a damp place.  
Do not place heavy objects on the playing surface.**

# ¡Felicitaciones por elegir los juegos Sportcraft!

Este juego fue fabricado usando materiales de alta calidad para fines recreativos.

## PRECAUCIÓN:

Lea este manual con atención y familiarícese con todas las piezas y contenido antes de comenzar el ensamblaje.

## ADVERTENCIA:

### PELIGRO DE ASFIXIA

Este juego contiene piezas pequeñas

### OBJETOS FILOSOS

Este juego contiene piezas que pueden tener bordes filosos. No se recomienda para niños menores de 8 años de edad.













## Cuidado de su mesa de juego:

Mantenga la mesa libre de polvo. Para eliminar el polvo use una toalla levemente húmeda y que no desprenda pelusas. Pase la toalla desde el centro de la superficie de la mesa hacia el borde de la mesa mientras la limpia.

No apoye objetos como bebidas sobre la superficie de juego ni sobre ninguna otra parte de la mesa ya que esto podría provocar daños a la mesa.

No la guarde en un lugar húmedo.  
No ponga objetos pesados sobre la superficie de juego.

# SPORTCRAFT

ASSEMBLY INSTRUCTION							
#1	CABINET		1 PC	#2	TABLE TENNIS BOARD		2 PCS
#3	BOLT 5/16"*2"		16 PCS	#4	LEGS		4 PCS
#5	LEG LEVELERS 5"		4 PCS	#6	ALLEN WRENCH		1 PC
#7	WASHER 5/16"*19mm		16 PCS	#8	NET END POST		2 PCS
A)	BRUSH		1 PC	B)	CHALK		2 PCS
C)	BILLIARD BALL		1 SET	D)	PLASTIC TRIPOD		1 PC
E)	CUE		2 PCS				

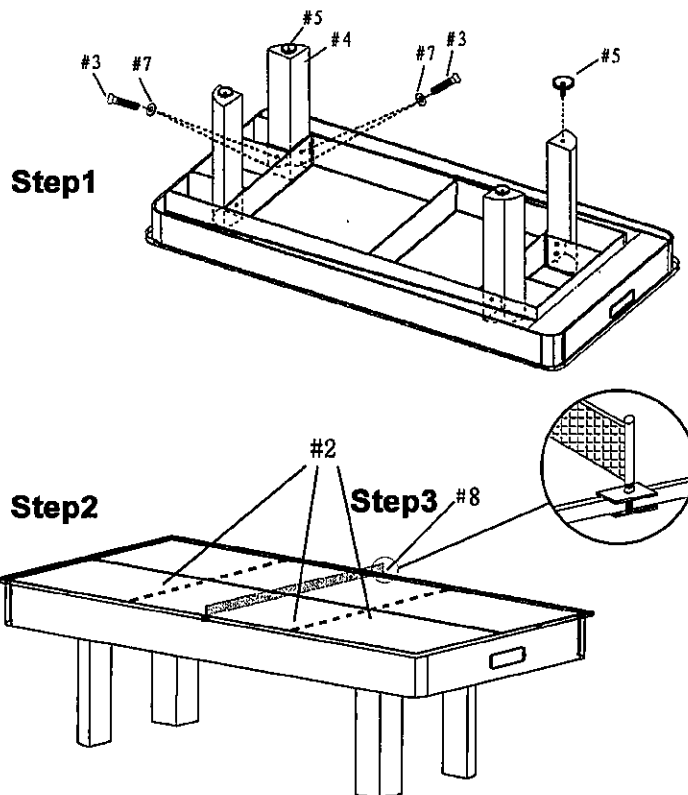

**Step1:** Carefully, with the help from another adult, flip the table upside down on a flat surface to assemble legs. Attach 4 legs (#4) using 16 (#3) bolts and 16 (#7) washers. Tighten with allen wrench (#6) DO NOT overtighten. Screw on the Leg Levelers to the bottom of all 4 legs (#5)

**Step2:** Carefully, with the help from another adult, flip the table over on to it's legs. Rack it up, Chalk the cues and play!

**Step3:** To play table tennis - Place the two table tennis boards (#2) on top of the pool table and slide end post (#8) onto the sides of the table tennis board.





## Limited Warranty

This product is warranted to be free of defects in workmanship or materials from the time of purchase for a period of 90 days. This limited warranty covers normal consumer usage. This limited warranty does not cover institutional or commercial use and does not cover failures which result from alterations, accidents, misuse, abuse, neglect, or acts of God.

Should evidence of defects in materials or workmanship or any customer service issues occur within the 90 day limited warranty period, please contact Lion Sports Inc.

Requests for warranty service can be made at 1-877-244-5466 between the hours of 9am and 4pm EST Monday through Friday or via email at [customerservice@lionsportsinc.com](mailto:customerservice@lionsportsinc.com)

This warranty gives you specific legal rights and you may have other rights which vary from state to state.



**Lion Sports Inc.**

**701 Koehler Ave. Ste 2**

**Ronkonkoma, NY 11779**

**Toll Free Customer Service Hotline – 1-877-244-5466**

**Or Email [customerservice@lionsportsinc.com](mailto:customerservice@lionsportsinc.com)**



Sportcraft® is a registered trademark of ABG-Sportcraft, LLC in the USA and other countries.

Sportcraft™ is a trademark of ABG-Sportcraft, LLC. ©2012 ABG-Sportcraft, LLC

The Lion Head and Lion Sports Logos are Registered Trademarks of Lion Sports Inc.



## Garantía limitada

Este producto está garantizado como libre de defectos de mano de obra o materiales desde el momento de la compra por un período de 90 días. Esta garantía limitada cubre el uso normal del consumidor. Esta garantía limitada no cubre el uso institucional o comercial y no cubre fallas debidas a alteraciones, accidentes, uso indebido, descuido o casos de fuerza mayor.

Si llegara surgir evidencia de defectos en los materiales o la mano de obra o cualquier problema de servicio al cliente dentro del período de 90 días de la garantía limitada, comuníquese con Lion Sports Inc.

Las solicitudes de servicio de garantía se pueden realizar llamando al 1-877-244-5466 de lunes a viernes entre las 9 a.m y las 4 p.m. hora oficial del Este o por correo electrónico a [customerservice@lionsportsinc.com](mailto:customerservice@lionsportsinc.com)

Esta garantía le otorga derechos legales específicos y usted podría tener otros derechos que varían de un estado a otro.



**Lion Sports Inc.**  
**701 Koehler Ave. Ste 2**  
**Ronkonkoma, NY 11779**

Línea directa de servicio al cliente sin costo 1-877-244-5466  
o por correo electrónico [customerservice@lionsportsinc.com](mailto:customerservice@lionsportsinc.com)



Sportcraft® es una marca comercial registrada de ABG-Sportcraft, LLC en los EE. UU. y otros países.  
Sportcraft® es una marca comercial de ABG-Sportcraft, LLC. ©2012 ABG-Sportcraft, LLC

Los logotipos de Lion Head y Lion Sports son marcas comerciales registradas de Lion Sports Inc.