

Furniture of America[®]

Assembly Instructions

CM-CR142-1/2/3

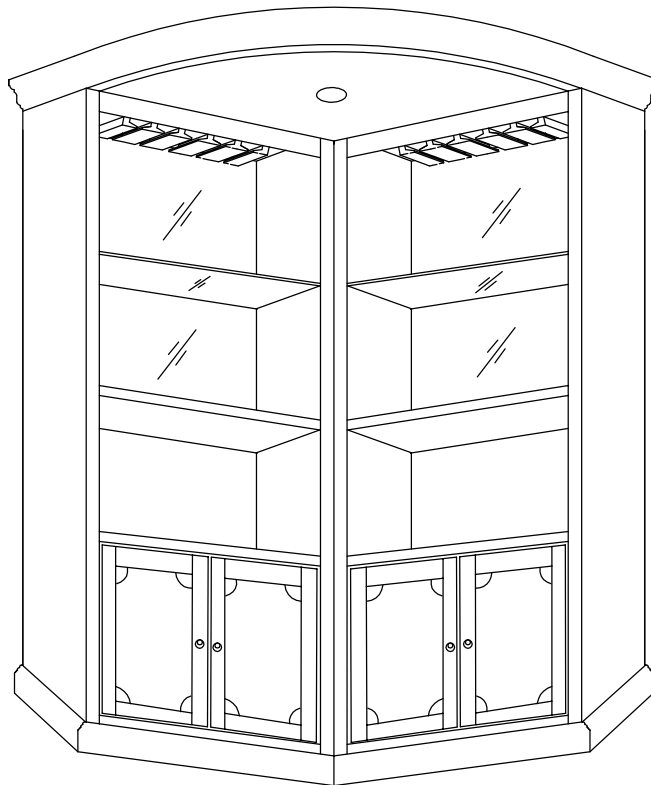

ASSEMBLY RATING

The Assembly Rating is a 5-point system that shows the degree of effort needed in assembling a specific product (with 1 being easy and 5 being difficult). For some products, two persons are recommended.

EASY  DIFFICULT

Tools Required For Assembly:

Wrench



(Included)

Phillips Screwdriver



(Not Included)

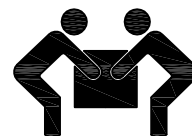

2 PERSONS RECOMMENDED

ASSEMBLY & CARE ADVICE

FOR YOUR FURNITURE TO LAST, CORRECT ASSEMBLY AND PROPER MAINTENANCE ARE NECESSARY. PLEASE FOLLOW THE INFORMATION PROVIDED BELOW TO FULLY ENJOY YOUR FURNITURE.

BASIC ASSEMBLY TECHNIQUES

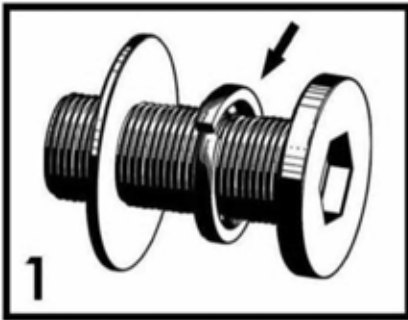

When lock or spring washer is used in an assembly, please make sure the lock or spring washer is placed between the larger flat washer and the head of the screw or bolt.

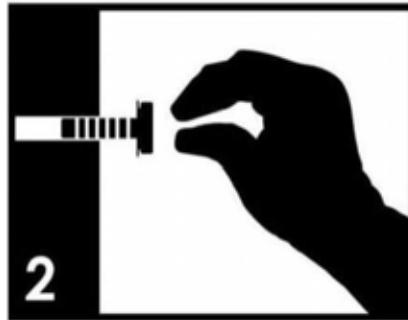

Position each part correctly and insert screws or bolts into their respective holes by hand tighten or using the proper hand tool. Only tighten when step is completed or when instructed to do so.

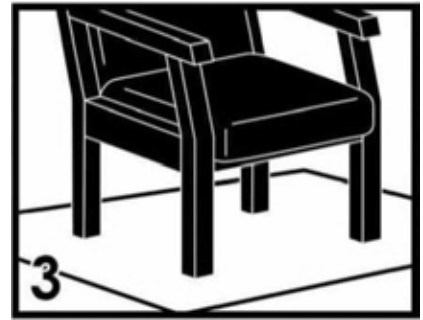

Use cardboard or carpet area when assembling furniture to prevent scratches. Make sure the furniture rests on a flat and level surface with each leg evenly touching the floor.

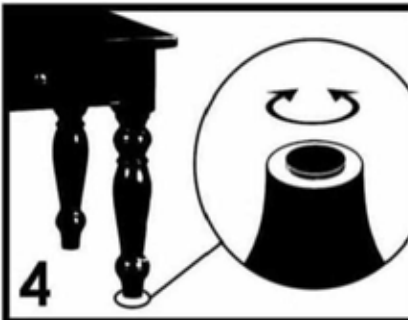

Some furniture comes with height adjustment knobs underneath each leg. To lower or to raise each leg, you need to turn clockwise or counterclockwise, respectively.

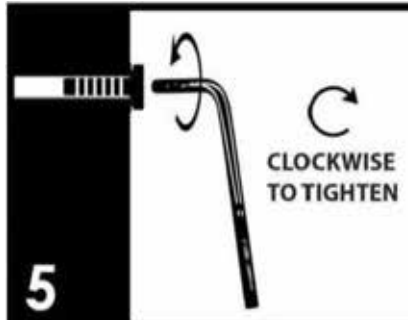

Make sure all parts are properly aligned, then use the appropriate hand tool to completely tighten the bolts or screws. Do not use power tools and do not overtighten.

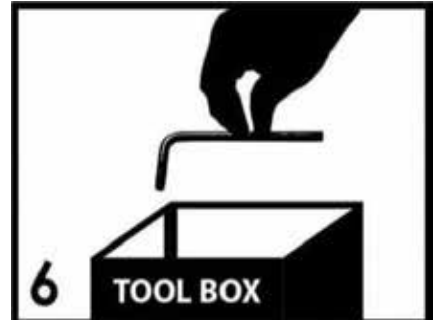

Save the instructions and store the Allen wrench or any supplied tool for later maintenance. After two weeks, check and tighten any loose hardware and repeat again every six months thereafter.

IT IS THE USER'S RESPONSIBILITY TO MAINTAIN THE FURNITURE. THE HARDWARE MAY LOOSEN OVER TIME AND MAY CAUSE THE FURNITURE TO BE WOBBLY AND UNABLE TO SUPPORT ITS INTENDED WEIGHT CAPACITY. THIS MAY LEAD TO COLLAPSE AND MAY CAUSE SERIOUS INJURY.

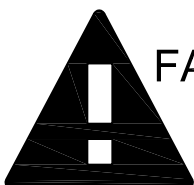

FAILURE TO FOLLOW THE GUIDELINES ABOVE MAY RESULT IN INJURY AND/OR PROPERTY DAMAGE.



Before you begin, please read Page 2 of "Assembly and Care Advice".

And remember, do not tighten until each step is completed or instructed.

Parts List

Hardware List



#1 x 1pc
Curio Cabinet Bridge



#A x 1pc
Wrench

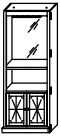

#2 x 1pc
Left Curio Cabinet

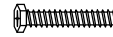

#B x 4pcs
Bolt 5/16"X1-1/2"

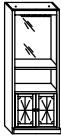

#3 x 1pc
Right Curio Cabinet



#C x 4pcs
Lock Washer



#4 x 2pcs
Glass Shelf



#D x 4pcs
Flat Washer

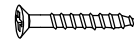

#E x 4pcs
Screw

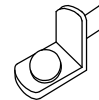

#F x 8pcs
support Bracket



#E x 4pcs
#F x 8pcs

- I. Align the right curio cabinet (#3) to the pre-drilled holes on the edge of the left curio cabinet (#2). Insert 4 screws (#E) and secure using the Phillips screwdriver.
- II. Insert support brackets (#F) into the pre-drilled holes located on the inner part of the cabinets. Four in each cabinet. Then apply the glass shelf.

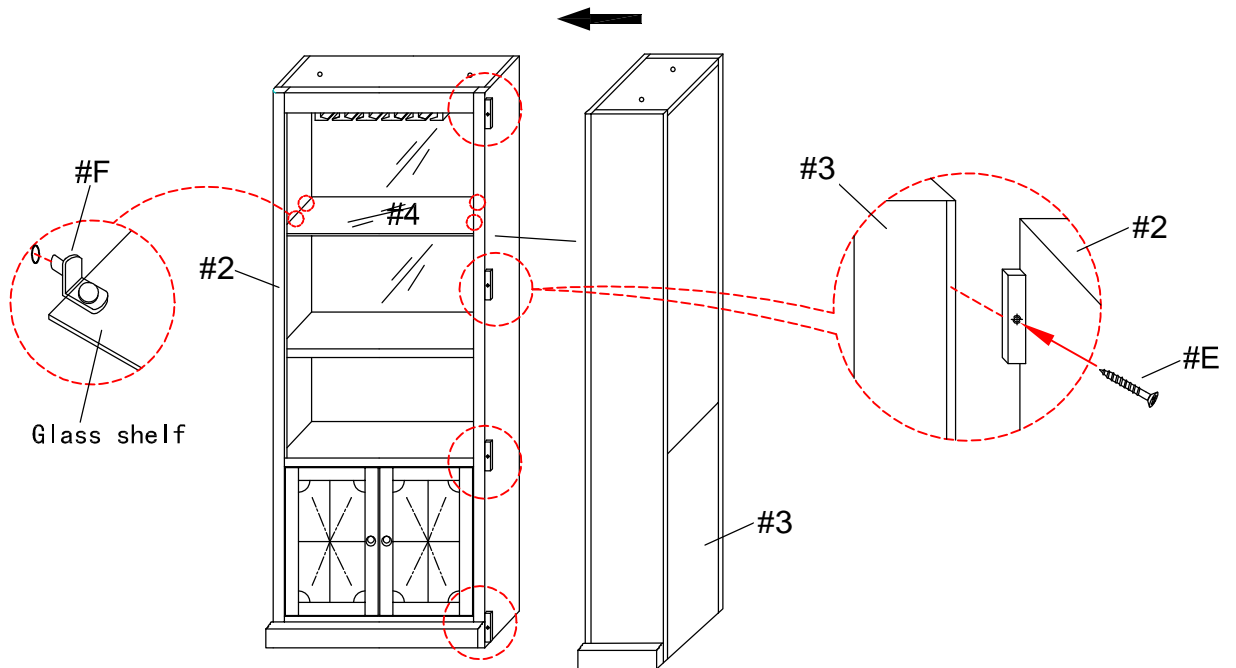

#B x 4pcs
#C x 4pcs
#D x 4pcs

Carefully place the curio cabinet bridge (#1) on top of the assembled cabinets. Align the pre-drilled holes. Prepare 4 bolt assemblies by FIRST inserting the lock washer (#C) onto the bolt (#B) then the flat washer (#D) onto that SAME bolt (#B). Insert bolt assemblies into the inner pre-drilled holes in the cabinets. Secure using the wrench (#A).

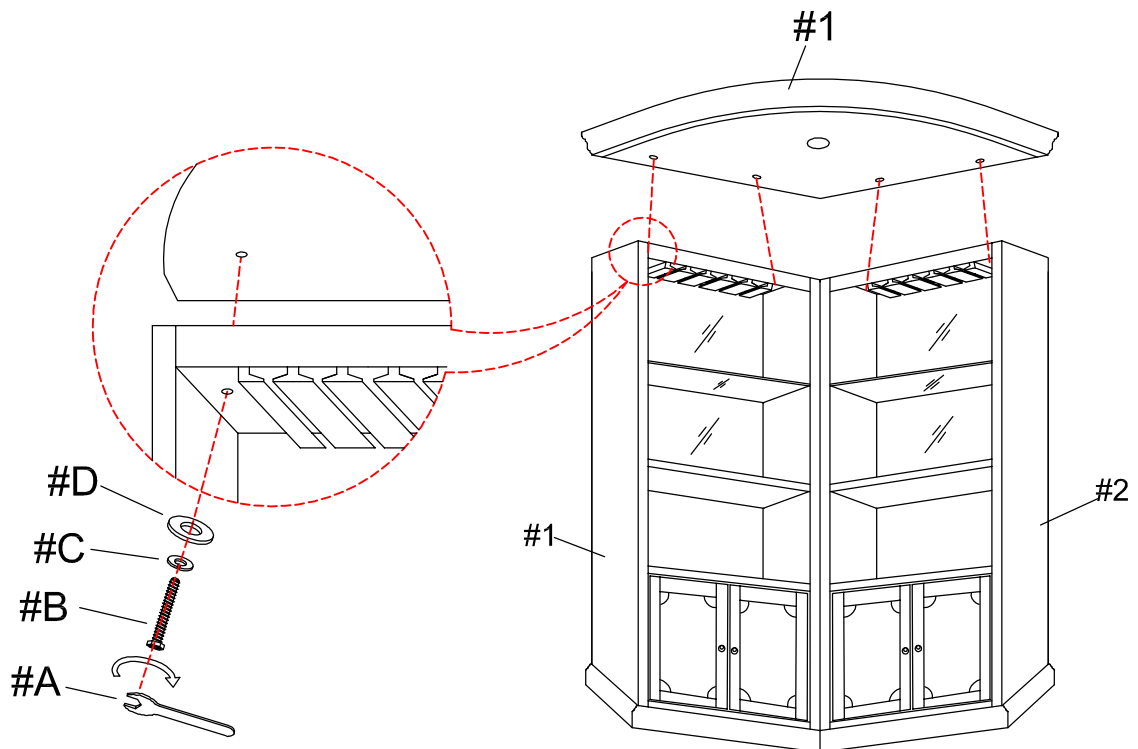

ASSEMBLY IS COMPLETED