

LOTOS LTP6000

Plasma Cutter

TABLE OF CONTENTS

SAFETY	2
SPECIFICATIONS	5
GENERAL DESCRIPTION.....	5
WHAT'S INCLUDED	5
POWER SUPPLY RATINGS	6
REAR CONTROL PANEL	7
CONTROLS AND SETTINGS.....	7
INSTALLATION	8
BEFORE INSTALLATION	8
INPUT CONNECTIONS.....	10
OUTPUT CONNECTIONS	11
OPERATION	13
MAINTENANCE	14
TROUBLESHOOTING	15
OTHER ACCESSORIES	17

SAFETY



PLEASE READ AND UNDERSTAND THE FOLLOWING SAFETY HIGHLIGHTS.

BE SURE THAT ALL INSTALLATION, OPERATION, MAINTENANCE AND REPAIR PROCEDURES ARE PERFORMED ONLY BY QUALIFIED INDIVIDUALS. ARC AND TIG WELDING CAN BE HAZARDOUS. PROTECT YOURSELF AND OTHERS FROM POSSIBLE SERIOUS INJURY OR DEATH. KEEP CHILDREN AWAY. PACEMAKER WEARERS SHOULD CONSULT WITH THEIR DOCTOR BEFORE OPERATING.

❖ **ELECTRIC AND MAGNETIC FIELDS may be dangerous**



- Electric current flowing through any conductor causes localized Electric and Magnetic Fields (EMF). Plasma cutting current creates EMF fields around plasma cutting cables and plasma cutters.
- EMF fields may interfere with some pacemakers, and users of plasma cutter having pacemakers should consult their physician before operating.
- Exposure to EMF fields in plasma cutting may have other health effects which are now not known.
- Use the following procedures in order to minimize exposure to EMF fields from the cutting circuit:
 - Connect the work cable to the work piece as close as possible to the area being cut.
 - Do not work next to power source.

❖ **ELECTRIC SHOCK can be fatal**



- The electrode and work (or ground) circuits are electrically “hot” when the machine is on. Do not touch these “hot” parts with your bare skin or wet clothing. Wear dry, hole-free gloves to insulate hands.
- Insulate yourself from work and ground using dry insulation. Make certain the insulation is large enough to cover your full area of physical contact with work and ground.
- Always be sure the work cable makes a good electrical connection with the metal being cut. The connection should be as close as possible to the area being cut.
- Ground the work metal to be cut to a good electrical (earth) ground.
- Maintain the plasma cutting torch, work clamp, power cable and cutting machine in good, safe operating condition. Replace damaged insulation.
- Never dip the electrode in water for cooling.
- When working above floor level, use a safety belt to protect yourself from a fall should you get a shock.

❖ **ARC RAYS can burn**

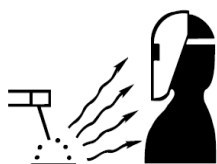

- Use a shield with the proper filter and cover plates to protect your eyes from sparks and the rays of the arc when plasma cutting or observing open arc plasma cutting.
- Use suitable clothing made from durable flame-resistant material to protect your skin and that of your helpers from the arc rays.
- Protect other nearby personnel with suitable, non-flammable screening and/or warn

them not to watch the arc nor expose themselves to the arc rays or to hot spatter or metal.

❖ **FUMES AND GASES can be dangerous**

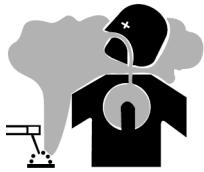

- Plasma cutting may produce fumes and gases hazardous to health. Avoid breathing these fumes and gases. When cutting, keep your head out of the fume. Use enough ventilation and/or exhaust at the arc to keep fumes and gases away from the breathing zone. In confined spaces or in some circumstances, outdoors, a respirator may be required. Additional precautions are also required when cutting on galvanized steel.
- Do not cut in locations near chlorinated hydrocarbon vapors coming from degreasing, cleaning or spraying operations. The heat and rays of the arc can react with solvent vapors to form phosgene, a highly toxic gas, and other irritating products.
- Read and understand the manufacturer's instructions for this equipment and the consumables to be used, including the material safety data sheet (MSDS) and follow your employer's safety practices. MSDS forms are available from your welding distributor or from the manufacturer.

❖ **CUTTING SPARKS can cause fire or explosion**

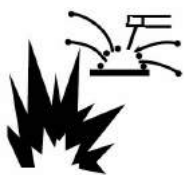

- Remove fire hazards from the cutting area. If this is not possible, cover them to prevent the welding sparks from starting a fire. Remember that cutting sparks and hot materials from cutting can easily go through small cracks and openings to adjacent areas. Avoid cutting near hydraulic lines. Have a fire extinguisher readily available.
- Where compressed gases are to be used at the job site, special precautions should be used to prevent hazardous situations.
- Do not heat, cut or weld tanks, drums or containers until the proper steps have been taken to insure that such procedures will not cause flammable or toxic vapors from substances inside. They can cause an explosion even though they have been "cleaned".
- Sparks and spatter are thrown from the cutting arc. Wear oil free protective garments such as leather gloves, heavy shirt, cuff-less trousers, high shoes and a cap over your hair. Wear ear plugs when welding out of position or in confined places. Always wear safety glasses with side shields when in a plasma cutting area.
- Connect the work cable to the work as close to the cutting area as practical. Work cables connected to the building framework or other locations away from the cutting area increase the possibility of the cutting current passing through lifting chains, crane cables or other alternate circuits. This can create fire hazards or overheat lifting chains or cables until they fail.

❖ **CYLINDER may explode if damaged**



- Use only compressed gas cylinders containing the correct shielding gas for the process used and properly operating regulators designed for the gas and pressure used. All hoses, fittings, etc. should be suitable for the application and maintained in good condition.
- Always keep cylinders in an upright position securely chained to an undercarriage or fixed support.
- Cylinders should be located:
 - Away from areas where they may be struck or subjected to physical damage.
 - A safe distance from arc welding or cutting operations and any other source of heat, sparks, or flame.

- Never allow any electrically “hot” parts to touch a cylinder.
- Keep your head and face away from the cylinder valve outlet when opening the cylinder valve.
- Valve protection caps should always be in place and hand tight except when the cylinder is in use or connected for use.

❖ **ELECTRICALLY POWERED EQUIPMENT can be dangerous**



- Turn off input power using the disconnect switch at the fuse box before working on the equipment.
- Install equipment in accordance with the local codes and the manufacturer’s recommendations.
- Ground the equipment in accordance with the manufacturer’s recommendations.

❖ **MOVING PARTS can cause injury**



- Keep away from moving parts such as fans.
- Keep all doors, panels, covers, and guards closed and securely in place.

.....
Please read this Operation Manual carefully and thoroughly before attempting to operate this machine. Keep this manual handy for quick reference. Pay close attention to the safety instructions provided for your own protection.
.....

SPECIFICATIONS

❖ GENERAL DESCRIPTION

The LOTOS LTP6000 Plasma Cutter is a heavy-duty machine, with a duty cycle of 60% at maximum output. The pilot arc feature is especially useful for continuous cutting on rough surfaces or dirty metal. The arc is started by high frequency which is known for producing more reliable, consistent, and cleaner cuts without having to spend extra time on cleaning. It is an ideal choice for factory maintenance, fabrication work, farm work, and auto body repairs.

- ✓ 60-Amp pilot arc plasma cutter
- ✓ Automatic dual frequency (50/60Hz)
- ✓ High frequency start and contact start hand torch
- ✓ Suitable for stainless steel, alloy steel, mild steel, copper and aluminum, etc.

❖ WHAT'S INCLUDED



- Power Supply
- Plasma Cutting Torch
- Plasma Cutting Consumables
- Ground Clamp
- Air Filter & Regulator
- Air Hose
- Air Hose Connections

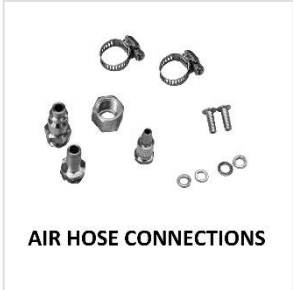

❖ POWER SUPPLY RATINGS

LTP6000		
General Specification	Input Voltage	220~240V ± 10%, 1-PH, 50/60Hz
	Input Current	30A
	No-load Voltage	230V
	Working Environment Humidity	≤90%
	Ambient Temperature	-10~40°C
	Dimensions	19" (483mm) L 8" (203mm) W 12" (305mm) H
	Weight	40lbs (18.1kg)
	Rated Duty Cycle ¹	60% @60A 100% @40A
	Power Cable	6' (1.8m)
Plasma Cutting Specification	Output Current	20~60A
	Open Circuit Voltage	230V
	Gas Supply	Clean, dry, oil-free air
	Recommended Pressure/Flow Rate	0.2~0.4Mpa, 4.0cfm @75psi (Minimum working pressure: 65psi)
	Post-flow Time	10s
	Pilot Arc Start Mode	High Frequency
	Maximum Severance Cutting Thickness ²	1 1/4" (31mm)
Material ²	Mild Steel	Ideal Cut 1" (25mm) @60A
	Stainless Steel	
	Aluminum	
Warranty	New Unit	1-Year Warranty
	Refurbished Unit	60-Day Warranty

¹ Duty Cycle is percentage of 10 minutes that unit can weld at rated load without overheating.

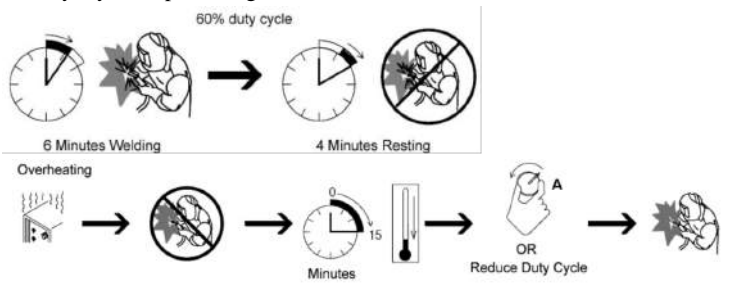

² Production cutting thickness are the results of LOTOS's laboratory testing. Production speeds are approximately 80% of maximum. For optimum cut quality, cutting speeds may vary based on different cutting applications.

❖ REAR CONTROL PANEL

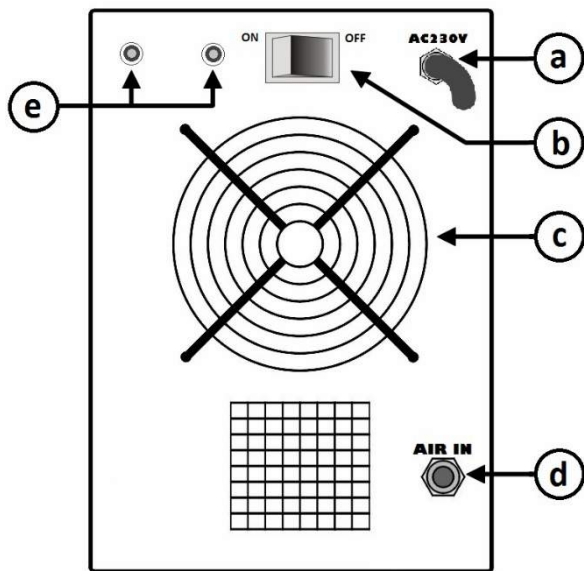

The unit is connected to the supply even if the Power Switch is in the “OFF” position, and therefore there are electrically live parts inside the power source. Carefully follow the instructions given in this manual.

REAR CONTROL PANEL	
a	Power Cord
b	Unit Power Switch
c	Cooling Fan
d	Air Inlet / Air Hose Connection
e	Air Regulator Mounts

❖ CONTROLS AND SETTINGS

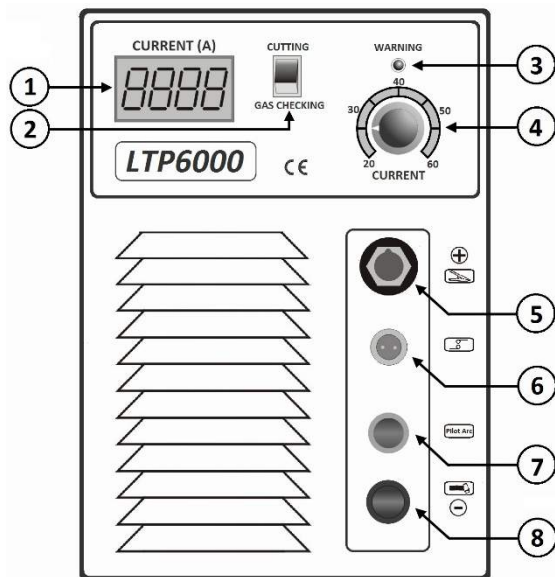

CONTROLS & SETTINGS	
1	Digital Display
2	Cutting/Gas Checking Switch ¹
3	Warning Light ²
4	Current Adjust Knob
5	Ground Cable & Clamp Connection (Electrode Positive)
6	Torch Trigger Control Connection
7	Pilot Arc Connection
8	Torch Power Connection (Electrode Negative)

The annotation will be used later in *Installation* section to avoid confusions.

¹ Switch between Cutting mode and Gas Checking mode.

² Warning light indicates over-current, over-heating or other electrical problems with the unit when the light is on.

INSTALLATION



PLEASE READ ENTIRE INSTALLATION SECTION BEFORE STARTING INSTALLATION. BE SURE THAT ONLY QUALIFIED PERSONNEL SHOULD PERFORM THIS INSTALLATION.

❖ BEFORE INSTALLATION

WARNING

ELECTRIC SHOCK can kill

- ♦ Turn the input power OFF and unplug the machine from the receptacle before working on this equipment. Allow machine to sit for 5 minutes minimum to allow the power capacitors to discharge before working inside this equipment.
- ♦ Insulate yourself from the work and ground.
- ♦ Always wear dry insulating gloves.
- ♦ Always connect the cutting machine to a power supply grounded according to the National Electrical Code and local codes.



➤ **SELECT SUITABLE LOCATION**

The Inverter will operate in harsh environments. Even so, it is important that simple preventative measures are followed in order to assure long life and reliable operation.

- The machine must be located where there is free circulation of clean air such that air movement in the back and out the front will not be restricted.
- Dirt and dust that can be drawn into the machine should be kept to a minimum. Failure to observe these precautions can result in excessive operating temperatures and nuisance shutdown.

➤ **STACKING**

LTP6000 cannot be stacked.

➤ **TILTING**

Place the machine directly on a secure, level surface. The machine may topple over if this procedure is not followed.

➤ **ENVIRONMENTAL AREA**

Keep the machine dry. Do not place it on wet ground or in puddles. Avoid rain water. Operating in rain is not allowed.

➤ **MACHINE GROUNDING AND HIGH FREQUENCY INTERFERENCE PROTECTION**

The Capacitor Discharge Circuit used in the high frequency generator, may cause many radio, TV and electronic equipment interference problems. These problems may be the result of radiated interference.

Proper grounding methods can reduce or eliminate radiated interference.

Radiated interference can develop in the following four ways:

1. Direct interference radiated from the plasma cutter.

2. Direct interference radiated from the plasma cutting leads.
3. Direct interference radiated from feedback into the power lines.
4. Interference from re-radiation of “pickup” by ungrounded metallic objects.

Keeping these contributing factors in mind, installing equipment per the following instructions should minimize problems.

- Keep the plasma cutter power supply lines as short as possible and enclose as much of them as possible in rigid metallic conduit or equivalent shielding for a distance of 50 feet (15.2m). There should be good electrical contact between this conduit and the welder case ground. Both ends of the conduit should be connected to a driven ground and the entire length should be continuous.
- Keep the work and electrode leads as short as possible and as close together as possible. Lengths should not exceed 25 feet (7.6m). Tape the electrode and work leads together into one bundle when practical.
- Be sure the torch and work cable rubber coverings are free of cuts and cracks that allow high frequency leakage.
- Keep the torch in good repair and all connections tight to reduce high frequency leakage.
- The work terminal must be connected to a ground within ten feet of the plasma cutter, using one of the following methods.
 - a) A metal underground water pipe in direct contact with the earth for ten feet or more.
 - b) A 3/4” (19mm) galvanized pipe or a 5/8” (16mm) solid galvanized iron, steel or copper rod driven at least eight feet into the ground.
- The ground should be securely made and the grounding cable should be as short as possible using cable of the same size as the work cable, or larger. Grounding to the building frame electrical conduit or a long pipe system can result in re-radiation, effectively making these members radiating antennas.
- Keep all panels securely in place.
- All electrical conductors within 50ft (15.2m) of the plasma cutter should be enclosed in grounded, rigid metallic conduit or equivalent shielding. Flexible metallic conduit is generally not suitable.
- When the plasma cutter is enclosed in a metal building, several earth driven electrical grounds connected (as in 5b above) around the periphery of the building are recommended.

Failure to observe these recommended installation procedures can cause radio or TV interference problems.

❖ INPUT CONNECTIONS

⚠ WARNING

ELECTRIC SHOCK can be fatal

- ♦ Have a qualified electrician install and service this equipment.
- ♦ Turn the input power OFF and unplug the machine from the receptacle before working on this equipment.
- ♦ Allow machine to sit for 5 minutes minimum to allow the power capacitors to discharge before working inside this equipment.
- ♦ Do not touch electrically hot parts.
- ♦ Machine must be plugged into a receptacle that is grounded according to the National Electrical Code and local codes.
- ♦ Do not remove or defeat the purpose of the power cord ground pin.



Be sure the voltage, phase, and frequency of the input power is as specified on the rating plate, located on the backboard of the machine.

➤ CONNECTION PROCEDURE

The Inverter LTP6000 must be connected to AC220V \pm 10%, 230V \pm 10%, 240V \pm 10%, 50/60Hz Single phase supply. The rated output of the LTP6000 is available when connected to a 30A branch circuit. When connected to a branch circuit with lower amp rating, lower welding current and duty cycle must be used.

Plug Wire Connection Example: 220V, 30A INPUT (Figure A.0)

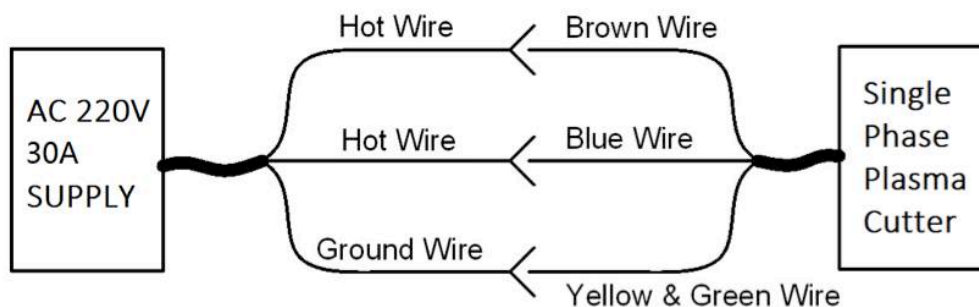

Figure A.0

⚠ WARNING

Failure to wire as instructed may cause personal injury or damage to equipment. To be installed or checked by an electrician or qualified person only.

In all cases, the green or green/yellow grounding wire must be connected to the grounding pin of the plug, usually identified by a green screw.

❖ OUTPUT CONNECTIONS

⚠ WARNING

ELECTRIC SHOCK can be fatal

- ◆ Keep the plasma cutting torch and ground cable & clamp in good condition and in safe place.
- ◆ Do not touch electrically live parts with skin or wet clothing.
- ◆ Insulate yourself from work pieces.
- ◆ Turn the machine "off" before connecting or disconnecting output cables or other equipment.



➤ GAS CONNECTION

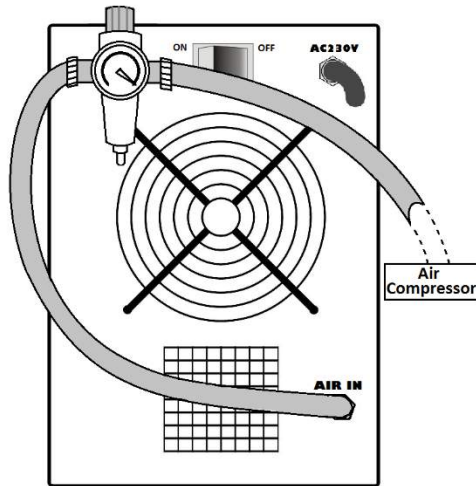

Figure A.1

Obtain the necessary air. Connect the cylinder of compressed air or air compressor with a pressure regulator and flow gage. Install an air hose between the regulator and gas inlet (located on the rear of the plasma cutter) using air hose accessories. The installed rear is shown in Figure A.1.

⚠ WARNING

CYLINDER could explode if damaged

- ◆ Keep cylinder upright and chained to a support.
- ◆ Keep cylinder away from areas where it could be damaged.
- ◆ Never allow the torch or welding electrode to touch the cylinder.
- ◆ Keep cylinder away from live electrical circuits.

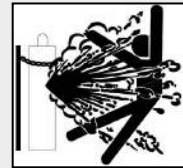

➤ CONSUMABLES INSTALLATION

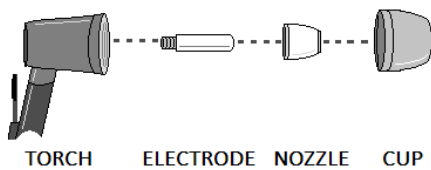

Figure A.2

The consumables set of electrode, nozzle and cup should install in order as shown in Figure A.2.

The LTP6000 can only use genuine LOTOS brand consumables sets of PCON serial.

One set of consumables has already been installed in the torch head.

➤ **OUTPUT CONNECTION** (Figure A.3)

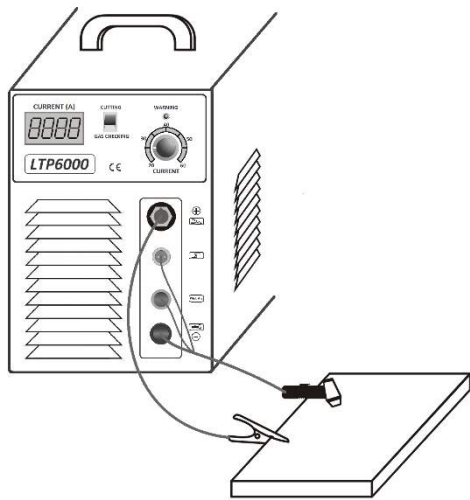

Figure A.3

The plasma cutting torch and ground cable are supplied with the plasma cutter. To connect the cables, turn the Power Switch “OFF”.

1. Plug the major power connector (the widest wire) from the torch cable to the “-” output terminal (8)¹. Turn it clockwise using the plastic safe protector until snug, do not over tighten.
2. Plug the 2-prong connector from the torch cable into the 2-pin socket (6). Turn the outer metal shell clockwise to tighten.
3. Take off the cap of the “pilot arc” socket (7) on the inverter, attach the connector with a metal chip from the torch cable to the socket, put the cap back on and turn clockwise to tighten.
4. Connect the ground cable & clamp to the “+” output terminal (5) and turn it clockwise to tighten.

To minimize high frequency interference, refer to *Machine Grounding and High Frequency Interference Protection* section of this manual for the proper procedure on grounding the work clamp and work piece.

⚠ WARNING

To avoid receiving a high frequency shock, keep the plasma cutting torch and ground clamp & cable insulation in good condition.

¹ The number inside “()” is the annotation in section *Specifications – Controls and Setting*.

OPERATION



PLEASE READ AND UNDERSTAND THIS ENTIRE SECTION BEFORE OPERATING YOUR MACHINE. ONLY QUALIFIED PERSONNEL SHOULD OPERATE THIS EQUIPMENT. OBSERVE ALL SAFETY INFORMATION THROUGHOUT THIS MANUAL.

⚠ WARNING

ELECTRIC SHOCK can be fatal

- ◆ Have an electrician install and service this equipment.
- ◆ Turn the input power off at the fuse box, disconnect or unplug supply lines and allow machine to sit for five minutes minimum to allow the power capacitors to discharge before working inside this equipment.
- ◆ Do not touch electrically hot parts. Turn the input power OFF and unplug the machine from the receptacle before working on this equipment.



FUMES AND GASES can be dangerous

- ◆ Keep your head out of fumes.
- ◆ Use ventilation or exhaust to remove fumes from breathing zone.

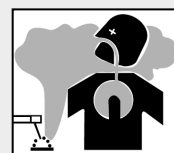

CUTTING SPARKS can cause fires or explosions

- ◆ Keep flammable material away.
- ◆ Do not weld, cut or gouge on containers that have held combustibles.

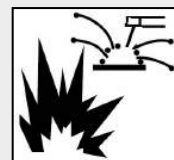

ARC RAYS can burn

- ◆ Wear eye, ear and body protection.



- 1) Connect up the air compressor using air filter and regulator as *Installation* indicates.
- 2) Install LTP6000 plasma cutting torch and ground cable & clamp as *Installation* indicates, turn the power ON.
- 3) Adjust the air pressure and make it is adequate to machine, open the valve of pressed air.
- 4) The recommended air pressure is 0.2~0.4Mpa, gas flow is 4.0cfm @75psi.
- 5) Set the function button to GAS CHECKING, check the torch head to confirm air flows out.
- 6) If gas does not flow out, turn the power OFF to check gas connections and air compressor. Then repeat 4).
- 7) If gas flows out smoothly, set the function button to CUT. Adjust output current by “Current Adjust Knob”. The output current can be adjusted from 20A to current level set by the user. The maximum current is 60A.
- 8) Press and hold the trigger to make a cut.

MAINTENANCE



PLEASE READ AND UNDERSTAND THIS ENTIRE SECTION BEFORE DOING MAINTENANCE FOR YOUR MACHINE. ONLY QUALIFIED PERSONNEL SHOULD OPERATE THIS EQUIPMENT. OBSERVE ALL SAFETY INFORMATION THROUGHOUT THIS MANUAL.

WARNING

ELECTRIC SHOCK can be fatal

- ◆ Have a qualified electrician install and service this equipment.
- ◆ Turn the input power off at the fuse box, disconnect or unplug supply lines and allow machine to sit for five minutes minimum to allow the power capacitors to discharge before working inside this equipment. Allow machine to sit for 5 minutes minimum to allow the power capacitors to discharge before working inside this equipment.
- ◆ Do not touch electrically hot parts.



❖ INPUT FILTER CAPACITOR DISCHARGE PROCEDURE

The machine has internal capacitors which are charged to a high voltage during power-on conditions. This voltage is dangerous and must be discharged before the machine can be serviced. Discharging is done automatically by the machine each time the power is switched off. However, the user must allow the machine to sit for at least 5 minutes to allow time for the process to take place.

❖ ROUTINE MAINTENANCE

Routine maintenance will prevent metal powder from accumulating near the aeration fins and over them.

Carry out the following periodic controls on the power source:

- Clean the power source inside by means of low pressure compressed air.
- Check the electric connections and all the connection cables.
- Always use gloves in compliance with the safety standards.

TROUBLESHOOTING



PLEASE READ AND UNDERSTAND THIS ENTIRE SECTION. SERVICE AND REPAIR SHOULD ONLY BE PERFORMED BY TRAINED PERSONNEL FOR YOUR SAFE, PLEASE OBSERVE ALL SAFETY INFORMATION THROUGHOUT THIS MANUAL.

WARNING

ELECTRIC SHOCK can kill

- ♦ Service and Repair should only be performed by Trained Personnel. Have a qualified electrician install and service this equipment.



❖ HOW TO USE TROUBLESHOOTING GUIDE

This Troubleshooting Guide is provided to help you locate and repair possible machine malfunctions. Simply follow the three-step procedure listed below.

Step 1. LOCATE PROBLEM (SYMPTOM).

Look under the column labeled “PROBLEM (SYMPTOMS)”. This column describes possible symptoms that the machine may exhibit. Find the listing that best describes the symptom that the machine is exhibiting.

Step 2. POSSIBLE CAUSE.

The second column labeled “POSSIBLE CAUSE” lists the obvious external possibilities that may contribute to the machine symptom.

Step 3. RECOMMENDED ACTION

This column provides a course of action for the Possible Cause.

If you do not understand or are unable to perform the Recommended Course of Action safely, contact your sales agency.

❖ **PROBLEMS IN PLASMA CUTTING**

TROUBLESHOOTING PLASMA CUTTING		
PROBLEMS (SYMPTOMS)	PROBLEM CAUSE	RECOMMENDED ACTION
Fan stops working	<ul style="list-style-type: none"> ◆ Fan power cord is off ◆ Enclosure blocks the fan that causes deformations ◆ The fan fails 	<ul style="list-style-type: none"> ◆ Reconnect the power cord ◆ Reform the enclosure ◆ Replace the fan
Warning light on	<ul style="list-style-type: none"> ◆ Over heat ◆ Over current 	<ul style="list-style-type: none"> ◆ Cut after cooling down ◆ Lower input voltage or replace machine
No output	<ul style="list-style-type: none"> ◆ Over current protection ◆ The machine fails 	<ul style="list-style-type: none"> ◆ Lower input voltage ◆ Do maintenance in manufacturer or service center
Output current decreased	<ul style="list-style-type: none"> ◆ Input voltage is too low ◆ Input line is too thin 	<ul style="list-style-type: none"> ◆ Increase input voltage ◆ Thicken power line
Current cannot be regulated	<ul style="list-style-type: none"> ◆ Connecting line of the potentiometer is off ◆ Potentiometer of current regulation fails 	<ul style="list-style-type: none"> ◆ Reconnection the line ◆ Replace the potentiometer
High frequency arc cannot be generated	<ul style="list-style-type: none"> ◆ The switch fails ◆ Incorrect selection for the air flow, the electrode fails ◆ High frequency arc generator fails 	<ul style="list-style-type: none"> ◆ Replace the switch ◆ Replace the electrode ◆ Replace the high frequency arc generator

OTHER ACCESSORIES

The following accessories and consumables can be purchased on www.uwelding.com, or call 408-739-2329 to order.

CONSUMABLES



ACCESSORIES

