

# 3 TIER GLASS BOOK SHELF

Style # 157002



## Assembly Instructions

We have designed our furniture with you, the customer in mind. Our clear, easy to follow, step by step instructions will guide you through the project from start to finish. Feel confident that this will be a fun and rewarding project. The final product will be a quality piece of furniture that will go together smoothly and give years of enjoyment.

## No tools required.



Please do not return to the store

- . Broken or Missing Parts?
- . Need help with Assembly?

If you have any questions just call 1-800-468-6447 or email us at [parts@convenience-concepts.com](mailto:parts@convenience-concepts.com)

**▲ CAUTION**

Use **ONLY** as directed.  
Product warranty is voided  
by altering product.

# Hardware Identification

For ease of identification all hardware is organized into separate Hardware Packs for each Step in the Instruction Manual.

## Hardware Pack

(A) End Caps X4

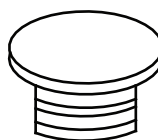

(B) Shelves X3

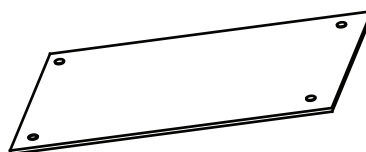

(C) Metal Poles X8

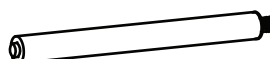

(D) Plastic Feet X4

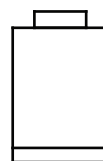

(E) Expansion Pipe X2



(F) Eyelet Screw X2



(G) Cable Tie X2



## Item Identification

For ease of identification all parts are labeled to correspond to the Step number in which the part is used.

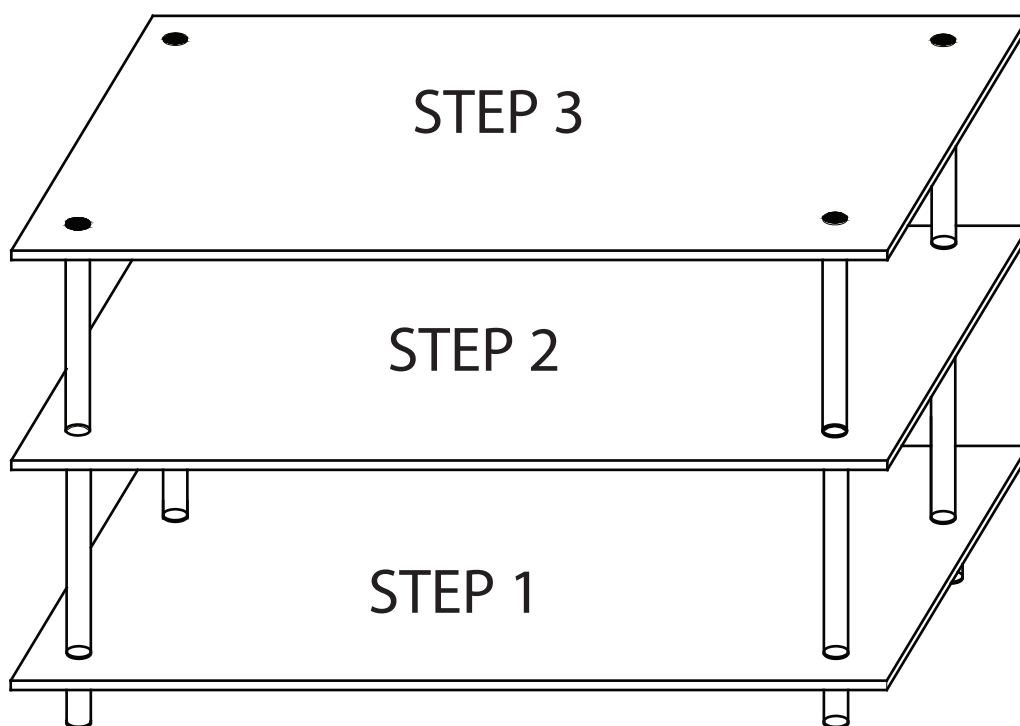

Gently screw metal poles (C) using care not to over tighten.

## STEP #1

### SHELF ASSEMBLY

Shelf 1

Hardware Pack 1

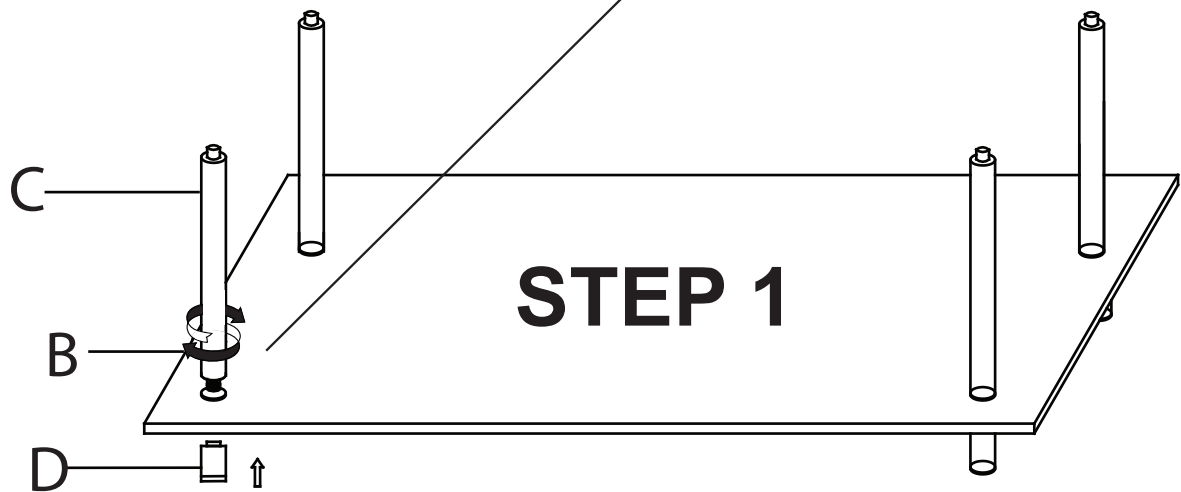
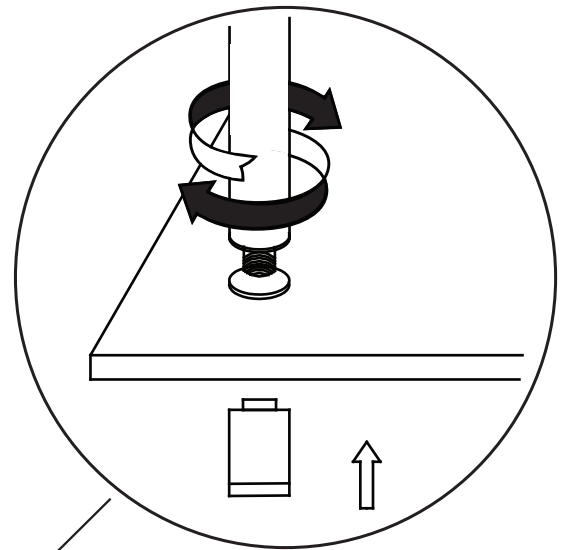
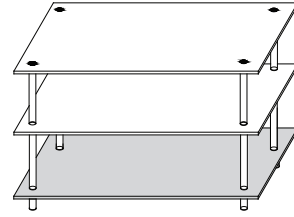

- (1) Place Shelf (B) on top of Plastic Feet (D).
- (2) Gently screw Poles (C) into Plastic Feet (D) using care not to over tighten.

**STEP #2**  
**SHELF ASSEMBLY**  
Shelf 2

Hardware Pack 1

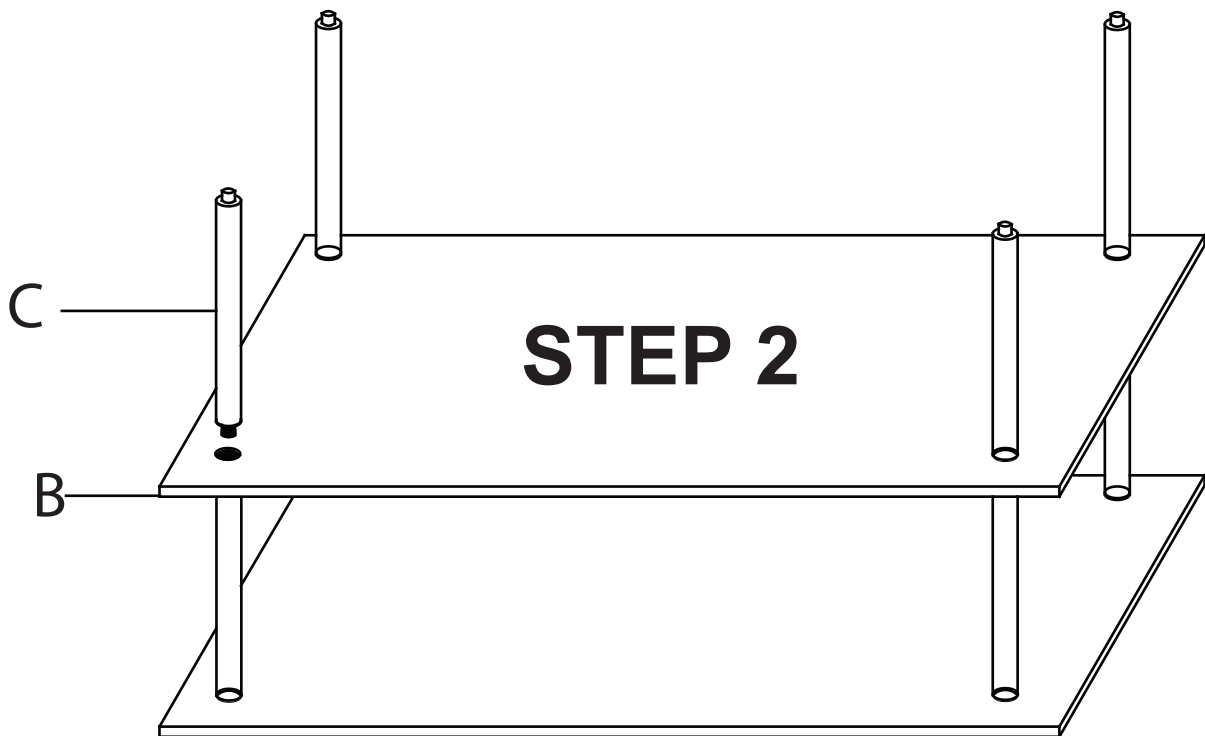
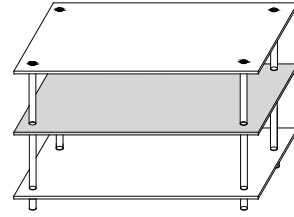

- (1) Place Shelf (B) onto Metal Poles (C).
- (2) Gently screw another set of Poles (C) into unit using care not to over tighten.

## STEP #3

### SHELF ASSEMBLY

Shelf 3

Hardware Pack 1

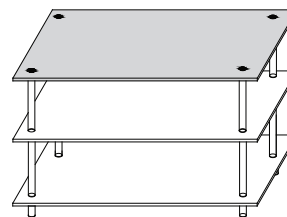

- (1) Place Shelf (B) onto assembly.
- (2) Fasten End Caps (A) using a clockwise rotation.
- (3).Drill hole slightly smaller than anchor (E) into drywall and gently tap anchor into hole.
- (4).Insert eyelet screw (F) into anchor and fasten unit to wall using cable tie.

