

# POWERSMART®

## INSTRUCTION MANUAL

22" 3-in-1 Self Propelled Lawn Mower

Model # DB8631



**Have product questions or need technical support? Please feel free to contact us!**

Website: [www.Amerisuninc.com](http://www.Amerisuninc.com)  
[www.powersmartusa.com](http://www.powersmartusa.com)

Toll free: 1-800-791-9458 Mon-Fri 9-5 EST  
Email: [support@amerisuninc.com](mailto:support@amerisuninc.com)



## **CONTENTS**

Technical data.....	3
Introduction.....	4
Safety information.....	4
General safety procedures .....	5
Important safety instructions.....	6
Knowing your lawn mower.....	8
Lawn mower preparation.....	9
Operation.....	12
Maintenance.....	15
Storage.....	16
Troubleshooting.....	17
Exploded view & parts list.....	18
Warranty.....	20

## **TECHNICAL DATA**

22" 3-in-1 Self Propelled Lawn Mower      Model # DB8631

Engine type:	4 stroke, OHV, single cylinder with forced air cooling system
Displacement:	196 cc
Fuel tank capacity:	0.9 Gallon
Oil capacity:	18 fl.oz
Cutting width:	22 inch
Cutting height:	1.2 – 3. 5 inch
Height adjustment:	5 Position
Drive type:	Rear- wheel drive
Grass catcher capacity:	1.5 Bushels
Wheel:	Front: 8 inch / Rear: 10 inch
Package dimensions (L x W x H):	37.6 x 24.4 x 18.1 inches
Weight:	80.5 lb

## **INTRODUCTION**

Thank You for Purchasing a PowerSmart® Product. This manual provides information regarding the safe operation and maintenance of this product. Every effort has been made to ensure the accuracy of the information in this manual. PowerSmart® reserves the right to change this product and specifications at any time without prior notice.

Please keep this manual available to all users during the entire life of the lawn mower.



This manual contains special messages to bring attention to potential safety concerns, lawn mower damage as well as helpful operating and servicing information. Please read all the information carefully to avoid injury and machine damage.

### **QUESTIONS? PROBLEMS?**

Please contact our Customer Service Dept. with any questions and/or comments, either by Email: support@amerisuninc.com, or Toll Free at (800) 791-9458. We are available Mon-Fri 9am-5pm EST to help solve any issues that you might encounter.

### **NOTICE REGARDING EMISSIONS**

Engines that are certified to comply with U.S. EPA emission regulations for SORE (Small Off Road Equipment), are certified to operate on regular unleaded gasoline, and may include the following emission control systems: (EM) Engine Modifications and (TWC) Three-Way Catalyst (if so equipped).

## **SAFETY INFORMATION**

Before operating this lawn mower, read and observe all warnings, cautions, and instructions on the lawn mower and in this Owner's Manual.

**NOTE:** The following safety information is not meant to cover all possible conditions and situations that may occur. Read the entire Owner's Manual for safety and operating instructions. Failure to follow instructions and safety information could result in serious injury or death.

This safety alert symbol is used to identify safety information about hazards that can result in personal injury.



A signal word (**DANGER**, **WARNING**, or **CAUTION**) is used with the alert symbol to indicate the likelihood and the potential severity of injury. In addition, a hazard symbol may be used to represent the type of hazard.

**DANGER** indicates a hazard, which, if not avoided, will result in death or serious injury.

**WARNING** indicates a hazard, which, if not avoided, could result in death or serious injury.

**CAUTION** indicates a hazard, which, if not avoided, might result in minor or moderate injury.

**CAUTION** when used without the alert symbol, indicates a situation that could result in damage to the engine.

## **GENERAL SAFETY PROCEDURES**

For any questions regarding the hazard and safety notices listed in this manual or on the product, please call (800) 791-9458 Mon-Fri 9-5 EST before using the engine.



### **DANGER: CARBON MONOXIDE**

Using an engine indoors **CAN KILL YOU IN MINUTES**. Engine exhaust contains carbon monoxide (CO). This is a poison gas you cannot see or smell. If you can smell the engine exhaust, you are breathing CO. But even if you cannot smell the exhaust, you could be breathing CO.

**NEVER** use an engine inside homes, garages, crawlspaces, or other partly enclosed areas. Deadly levels of carbon monoxide can build up in these areas. Using a fan, or opening windows and/or doors will **NOT** properly vent CO nor supply adequate fresh air. **ONLY** use an engine outside and far away from windows, doors, and vents. These openings can pull in engine exhaust.

Even if you use an engine correctly, CO may leak into the home. **ALWAYS** use a battery-powered or battery-backup CO alarm in the home. If you start to feel sick, dizzy, or weak after the engine has been running, move to fresh air **RIGHT AWAY**. See a doctor. You may have carbon monoxide poisoning.

**WARNING:** The exhaust from this product contains chemicals known to the State of California to cause cancer, birth defects, or other reproductive harm.

**WARNING:** This engine may emit highly flammable and explosive gasoline vapors, which can cause severe burns or even death if ignited. A nearby open flame can lead to explosion even if it isn't directly in contact with gasoline.

- Do not operate near an open flame.
- Do not smoke near the engine.
- Always operate on a firm, level surface.
- Always turn engine off before refueling. Allow engine to cool for at least 2 minutes before removing fuel cap. Loosen cap slowly to relieve pressure in tank.
- Do not overfill fuel tank. Gasoline may expand during operation. Do not fill to the top of the tank. Allow for expansion.
- Always check for spilled fuel before operating.
- Empty fuel tank before storing or transporting the engine.

**WARNING:** This engine produces heat when running. Temperatures near exhaust can exceed 150°F (65°C).

Do not touch hot surfaces. Pay attention to warning labels on the engine identifying hot parts of the machine.

Allow engine to cool down after use before touching engine or areas of the engine that become hot during use.

**CAUTION:** Misuse of this engine can damage it or shorten its life. Only use engine for its intended purposes.

# **IMPORTANT SAFETY INSTRUCTIONS**

## **General Operation**

Read, understand, and follow all instructions on the machine and in the manual(s) before starting.

1. Do not put hands or feet near or under the machine. Keep clear of the discharge opening at all times.
2. Only allow responsible adults, who are familiar with the instructions, to operate this machine.
3. Clear the area of objects such as rocks, wire, toys, etc., which could be thrown by the blade. Stay behind the handle when the engine is running.
4. Be sure the area is clear of bystanders before operating. Stop machine if anyone enters the area.
5. Do not operate machine barefooted or while wearing sandals. Always wear substantial footwear.
6. Do not pull machine backward unless absolutely necessary. Always look down and behind before and while moving backward.
7. Never direct discharged material toward anyone. Avoid discharging material against a wall or obstruction. Material may ricochet back toward the operator. Stop the blade when crossing gravel surfaces.
8. Do not operate machine without the entire grass catcher, discharge guard, rear guard, or other safety protective devices in place and working.
9. Never leave a running machine unattended.
10. Stop the engine and wait until the blade comes to a complete stop before cleaning the machine, removing grass catcher, or unclogging the discharge guard.
11. Operate machine only in daylight or good artificial light.
12. Do not operate machine while under the influence of alcohol or drugs.
13. Never operate mower in wet grass. Always be sure of your footing; walk; never run.
14. Disengage the drive system, if so equipped, before starting the engine.
15. If the machine should start to vibrate abnormally, stop the engine and check for the cause immediately. Vibration is generally a warning of trouble.
16. Always wear eye protection when operating machine.
17. See manufacturer's instructions for proper operation and installation of accessories. Only use accessories approved by the manufacturer.

## **Slope Operation**

Slopes are a major factor related to slip and fall accidents, which can result in severe injury. Operation on all slopes require extra caution. If you feel uneasy on a slope, do not mow it.

1. Mow across the face of slopes; never up and down. Exercise extreme caution when changing direction on slopes.
2. Watch for holes, ruts, bumps, rocks, or other hidden objects. Uneven terrain could cause a slip and fall accident. Tall grass can hide obstacles.
3. Do not mow on wet grass or excessively steep slopes. Poor footing could cause a slip and fall accident.
4. Do not mow near drop-offs, ditches, or embankments. You could lose your footing or balance.

## **Children**

Sever injury can occur if the operator is not alert to the presence of children in the immediate area. Children are often attracted to the mowing activity. Never assume that children will remain where you last saw them.

1. Keep children out of the mowing area and under the watchful care of a responsible adult other than the operator.
2. Be alert and turn mower off if a child enters the area.
3. Never allow children under the age of 16 to operate the lawn mower.

4. Use extra care when approaching blind corners, shrubs, trees, or other objects that may block your view of a child.

### **Service**

1. Safe Handling of Gasoline
2. To avoid personal injury or property damage, use extreme care in handling gasoline. Gasoline is extremely flammable and the vapors are explosive.
3. Extinguish all cigarettes, cigars, pipes, and other sources of ignition.
4. Only use a US EPA approved compliant portable fuel container.
5. Never remove gas cap or add fuel with the engine running. Allow engine to cool before refueling.
6. Never attempt to refuel the lawn mower while indoors.
7. Never store the machine or fuel container where there is an open flame, spark, or pilot light such as on a water heater or on other appliances.
8. Never fill containers inside a vehicle or on a truck or trailer bed with a plastic liner. Always place containers on the ground away from your vehicle before filling.
9. Remove gas-powered equipment from the truck or trailer and refuel it on the ground. If this is not possible, then refuel such equipment with a portable container, rather than from a gasoline dispenser nozzle.
10. Keep the nozzle in contact with the rim of the fuel tank or container opening at all times until fueling is complete. Do not use a nozzle lock-open device.
11. If fuel is spilled on clothing, change clothing immediately.
12. Never overfill fuel tank. Replace gas cap and tighten securely.

### **General Service**

1. Never operate machine in a closed area.
2. Keep all nuts and bolts tight to be sure the equipment is in safe working condition.
3. Never tamper with safety devices. Check their proper operation regularly.
4. Keep machine free of grass, leaves, or other debris build-up. Clean up oil or fuel spillage and remove any fuel-soaked debris. Allow machine to cool before storing
5. If you strike a foreign object, stop and inspect the machine. Repair, if necessary, before starting.
6. Never make any adjustments or repairs with the engine running. Disconnect the spark plug wire to prevent unintended starting.
7. Check grass catcher components and the discharge guard frequently and replace with manufacturer's recommended parts, when necessary.
8. Mower blades are sharp. Wrap the blade or wear gloves, and use extra caution when servicing them.
9. Do not change the engine governor setting or overspeed the engine.
10. Maintain or replace safety and instruction labels, as necessary.

# KNOWING YOUR LAWN MOWER

Please use the illustration below to familiarize yourself with the location and function of the components that control of your lawn mower.

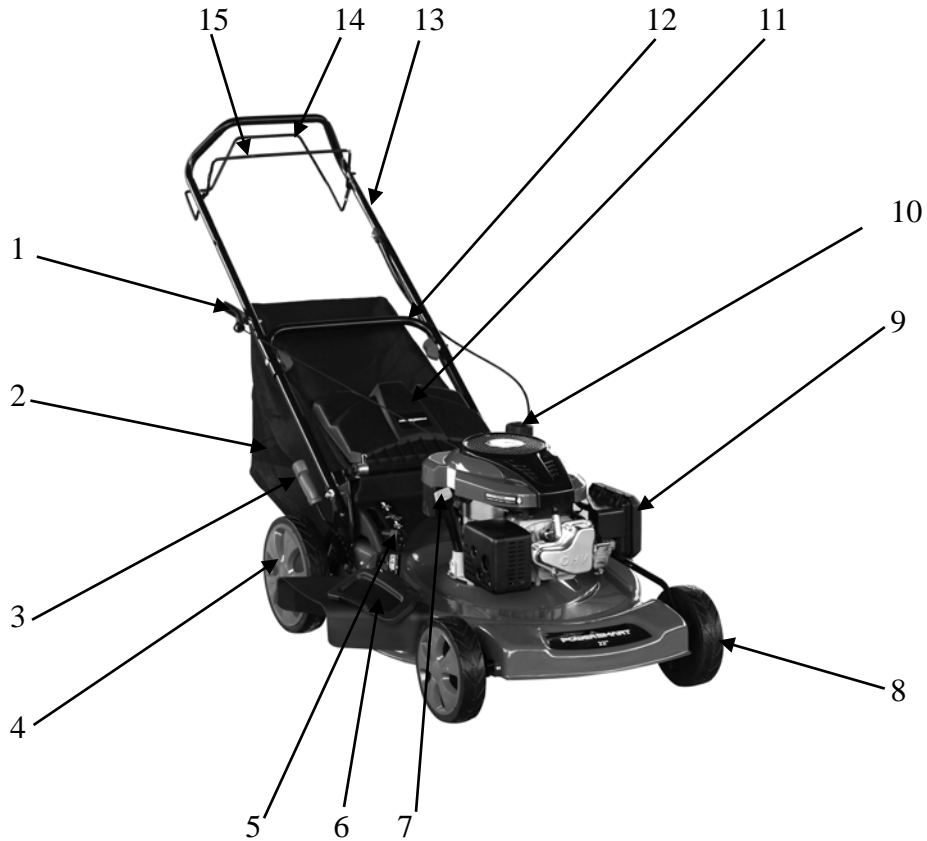

1	Recoil Starter handle	9	Air Filter
2	Grass catcher	10	Fuel tank cap
3	Cutting height adjustment lever	11	Rear discharge door
4	Rear wheel	12	Lower handle
5	Mulching control lever	13	Upper handle
6	Side discharge cover	14	Engine start/stop lever
7	Oil dipstick	15	Drive control bar
8	Front wheel		



# LAWN MOWER PREPARATION

The following section describes steps necessary to prepare the lawn mower for use. If after reading this section, you are unsure about how to perform any of the steps please call (800) 791-9458 Mon-Fri 9-5 EST for customer service. Failure to perform these steps properly can damage the lawn mower or shorten its lifespan.

## UNPACKING

Unpack the lawn mower and all its parts, and compare against the list below. Do not discard the carton or any packaging until the engine is completely assembled.

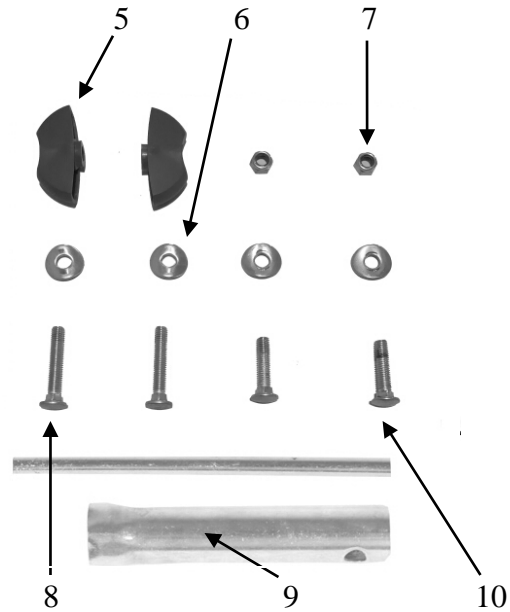
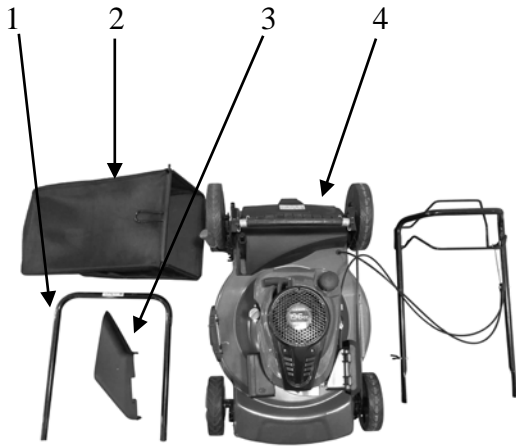

- 1 Lower handle
- 2 Grass Catcher
- 3 Side discharge chute
- 4 Lawn mower with upper handle
- 5 Knob (2)

- 6 Washer (4)
- 7 Nut M8 (2)
- 8 Screw M8×45 (2)
- 9 Spark plug wrench
- 10 Screw M8×35 (2)

## ATTACH LOWER & UPPER HANDLE

1. Take lower handle and line up the hole in the lower handle with the hole on the handle bracket.
2. Secure the lower handle with handle bracket with provided M8 screw (1) , M8 nut (1) and Saddle washer on each side.

M8 Screw, Nut  
and washer

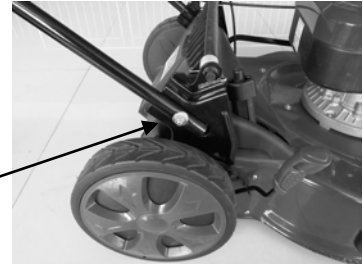

3. Pull upper handle up and lock it in position with bolts, washer and knob on both side.

Knob, washer and screw

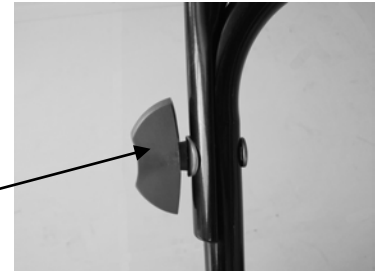

4. Insert the recoil starter handle cable into the hook provided on the upper handle.

Recoil starter handle



## GRASS CATCHER

### Attach grass catcher

1. Lift mower rear discharge door.
2. Place grass catcher into the slots in the handle brackets.
3. Release the rear discharge door so that it rests on the grass catcher.

**Caution:** Make sure that the Mulching Control Lever is in the bagging position



### Remove grass catcher

1. Lift mower rear discharge door.
2. Lift grass catcher up and off the slots in the handle bracket.
3. Move the Mulching Control lever to the mulching position .
4. Release mower rear discharge door to allow it to close rear opening of mower.



## SIDE DISCHARGE CHUTE

To convert mower for side discharge, ensure that the mulching control lever is in the mulching position, the grass catcher has been removed and that the rear discharge door is closed.

1. Lift the spring-loaded discharge cover located on the side of the mower.
2. Slide two hooks of the side discharge chute under the hinge pin and lower the spring on the side discharge cover.

**Caution:** Do not attempt to remove the permanently mounted spring loaded side discharge cover at any time.



## ADJUSTING THE CUTTING HEIGHT



**Warning!** Cutting height adjustments should only be performed after the engine and blades have come to a complete stop!

It is always best to begin cutting your lawn with a higher deck height to prevent scalping your lawn.

The cutting height is adjusted with a single lever.  
Actuate the adjustment lever and pull it to the required position.  
Please make sure that the lever locks into position.

Cutting height adjustment lever



## OPERATION

### GAS AND OIL FILL-UP

The engine comes shipped without oil or gasoline. Be sure to add oil and gasoline before starting the engine.

Refer to the separate engine operator's manual for additional engine information.

1. Add oil before starting mower for the first time.
2. Service the engine with gasoline as instructed in the separate engine operator's manual.



**Warning:** Use extreme care when handling gasoline. Gasoline is extremely flammable and its vapors are explosive. Never fuel the machine indoors or while the engine is hot or running. Extinguish all cigarettes, cigars, pipes and other potential sources of ignition.

## ENGINE START/STOP LEVER

This lawn mower comes equipped with an engine start/stop lever to prevent unintentional starting and to ensure safe operation. Releasing this lever will quickly stop the blade in case of danger. The lever must be actuated before the lawn mower is started. When the engine start/stop lever is released, it must return to its initial position.

Before you start mowing, you should run through this process several times in order to ensure that the lever and actuator cables are working properly. Repeat the test several times after the engine has started up. When the engine start/stop lever is released, the engine must stop within a few seconds. If not, contact Customer Service.



**Warning:** The blade begins to rotate as soon as the engine is started.

## START THE ENGINE

1. Ensure that the ignition cable is connected to the spark plug.
2. Stand behind the lawn mower. Actuate the engine start/stop lever with one hand. The other hand must be on the starter handle.
3. Start the engine using the starter handle. To do this pull out the handle approx. 4 –6 inches (until you feel a resistance) and then start the engine with a sharp tug. If the engine does not start, tug the handle again.

**Caution:** Never allow the actuator cable to snap back.

**Caution:** In cold weather, it may be necessary to repeat the starting process several times.

## STOP THE ENGINE

Release the engine start/stop lever to stop the engine.

## DRIVE CONTROL BAR

If you press drive control bar the clutch for the drive will be closed and the lawnmower will start to move with the engine running. Release the drive control bar in good time to stop the moving lawnmower.

Practice starting and stopping before you use the mower for the first time until you are familiar with controlling the mower.

## MOWING

The engine throttle on your mower has been preset to provide optimum bagging and mulching performance for years to come.

Only use a sharp blade that is in good condition. This will prevent the grass blades from becoming frayed and the lawn from turning yellow.

Mow in straight lines for a nice, clean look. The swaths should overlap each other by a few inches in order to avoid stripes.

Engine start/stop lever



Drive control bar



It's important to keep the underside of the mower deck clean and remove grass build-up. This buildup will decrease mulching quality, and make it harder for the equipment to bag the grass.

Always mow along inclines (not up and down). You can prevent the lawn mower from slipping down by holding a position at an angle upwards. Select the cutting height according to the length of the grass. If necessary, mow a number of times so that you never cut more than 2 inches of grass in one go.

Turn off the engine before doing any checks on the blade. Keep in mind that the blade continues to rotate for a few seconds after the engine has been turned off. Never attempt to manually stop the blade. Regularly check to see if the blade is securely attached, is in good condition and is sharp. If the contrary is the case, sharpen the blade or replace it. In the event that the blade strikes an object, immediately turn off the lawn mower and wait for the blade to come to a complete stop. Then inspect the condition of the blade and the blade mount. Replace any parts that are damaged.

### USING AS MULCHING CONTROL LEVER

If the Grass Catcher is on the mower, and the Mulching Control Lever is in the bagging position, move the lever to the mulching position before mulching the clippings.

If the Side-discharge Chute is on the mower, remove it before mulching the clippings.

Mulching control lever



### USING AS SIDE DISCHARGE

You should fit the mulching adapter in order to use the side discharge.

1. On the side of the mower, lift the side discharge cover.
2. Slide two hooks of side discharge chute under hinge pin on the side discharge cover. Lower the side discharge cover.

**Caution:** Do not remove side discharge cover at any time.



### USING AS A REAR BAGGER

To use the grass catcher to collect clippings while you are operating the mower.

1. Attached grass catcher following instruction in the lawn mower preparation. Grass clippings will automatically collect in bag as you run the mower. Operate mower until grass catcher is full.
2. Stop engine completely by releasing the engine start/stop lever. Make sure that the engine has come to a complete stop.
3. Lift rear discharge door and pull grass catcher up and away from the mower to remove the grass catcher. Dispose of the grass clippings and reinstall the grass catcher when complete.

 **Warning:** If you strike a foreign object, stop the engine. Remove spark plug wire, thoroughly inspect mower for any damage, and repair damage before restarting and operating. Excessive vibration of the mower during operation is an indication of damage. The mower should be promptly inspected and repaired.

## **MAINTENANCE**

Proper routine maintenance of this mower will help prolong the life of the machine.

Always observe safety rules when performing any maintenance.

The warranty on this lawn mower does not cover items that have been subjected to operator abuse or negligence. To receive full value from warranty, operator must maintain the lawn mower as instructed here.

Changing of engine-governed speed will void engine warranty.

All adjustments should be checked at least once each season.

Periodically check all fasteners and make sure these are tight.



**Warning:** Always stop engine, allow engine to cool, disconnect spark plug wire before performing any type of maintenance on your machine.

### **DECK CARE**

It is important to clean underside of the mower deck after use to prevent the build-up of grass clippings or other debris. Follow steps below for proper cleaning.

1. Allow the engine to run until it is out of fuel. Do not attempt to pour fuel from the engine.
2. Disconnect spark plug wire. Refer to engine operator's manual.
3. Slowly tip mower so that it rests on the housing.
4. To prevent oil spills, always tip the mower so that the Air Filter is facing up.
5. Hold mower firmly and scrape and clean the underside of the deck with a suitable tool.
6. Gently lower the mower back on its wheels on the ground.

**Warning:** Never tip the mower more than 90° in any direction and do not leave the mower tipped for any length of time. Oil can drain into the upper part of the engine causing a starting problem.

### **MOWER BLADE**

To ensure safe operation, have all blade sharpening, balancing and mounting work carried out by an authorized service center. To achieve optimal results, we recommend having the blade checked once a year.

If, in spite of all caution, the blade comes into contact with an obstacle, switch off the engine immediately and pull off the spark plug connector. Tilt the lawn mower to the rear and check the blade for damage. Always keep the side with the air cleaner facing up. Damaged or bent blades must be replaced. Never straighten a bent blade. Never work with bent or heavily worn blades as this will result in vibrations, causing further damage to the mower.



**Warning:** Risk of injury when working with a damaged blade.

## **STORAGE**

**CAUTION:** Never place any type of storage cover or tarp on the MOWER while it is still hot.

If the MOWER is being stored for short periods of time (30 to 60 days), add stabilized fuel to the gas tank until it is full. Run the engine for 2 – 3 minutes allowing stabilized fuel mixture to circulate through the carburetor.

**NOTE:** Keeping the fuel tank full, reduces the amount of air and vapor and helps reduce deterioration of the fuel. This will also help minimize moisture accumulation common with ethanol blended fuels.

When storing the mower for extended periods of time:

1. Start the engine and run it until the tank and fuel line are completely empty and the engine stalls.
2. Change the oil after each season.
3. Remove the spark plug. Use an oil-can to fill the cylinder with approx. 2 ml of oil. Slowly pull back the starter handle, which will bathe the cylinder wall with oil. Screw the spark plug back in.
4. Clean the cooling fins of the cylinder and the housing.
5. Be sure to clean the entire equipment to protect the paint.
6. Store the equipment in a well-ventilated place.



## **TROUBLESHOOTING**

<b>Problem</b>	<b>Cause</b>	<b>Solution</b>
Engine fails to start	Engine start/stop lever disengaged.	Engage engine start/stop lever.
	Spark plug wire disconnected.	Connect spark plug wire.
	Fuel tank empty or stale fuel.	Fill tank with clean, fresh gasoline.
	Engine not primed.	Press primer bulb.
	Faulty spark plug.	Clean, adjust gap, or replace.
	Blocked fuel line.	Clean fuel line.
	Engine flooded.	Wait a few minutes to restart, do not prime.
Engine runs erratic.	Spark plug wire loose.	Connect and tighten spark plug wire.
	Blocked fuel line or stale fuel.	Clean fuel line. Fill tank with clean, fresh gasoline.
	Water or dirt in fuel system.	Drain fuel tank. Refill with fresh fuel.
	Dirty air filter	Please refer to engine manual.
Engine overheats.	Engine oil level low.	Fill crankcase with proper oil.
	Air flow restricted.	Clean area around and on top of engine.
Idles poorly.	Spark plug fouled, faulty, or gap too wide.	Reset gap or replace spark plug.
	Dirty air cleaner.	Please refer to engine manual.
Excessive vibration/noise	Blade loose or unbalanced.	Tighten and balance blade.
	Bent/damaged blade.	See an authorized service dealer.
Mower will not mulch grass.	Wet grass.	Do not mow when grass is wet, wait until dry to cut.
Uneven cut.	Excessively high grass.	Mow once at a high cutting height, then mow again at desired height or make a narrower cutting path.
	Dull blade.	Sharpen or replace blade.

**EXPLODED VIEW AND PARTS LIST**

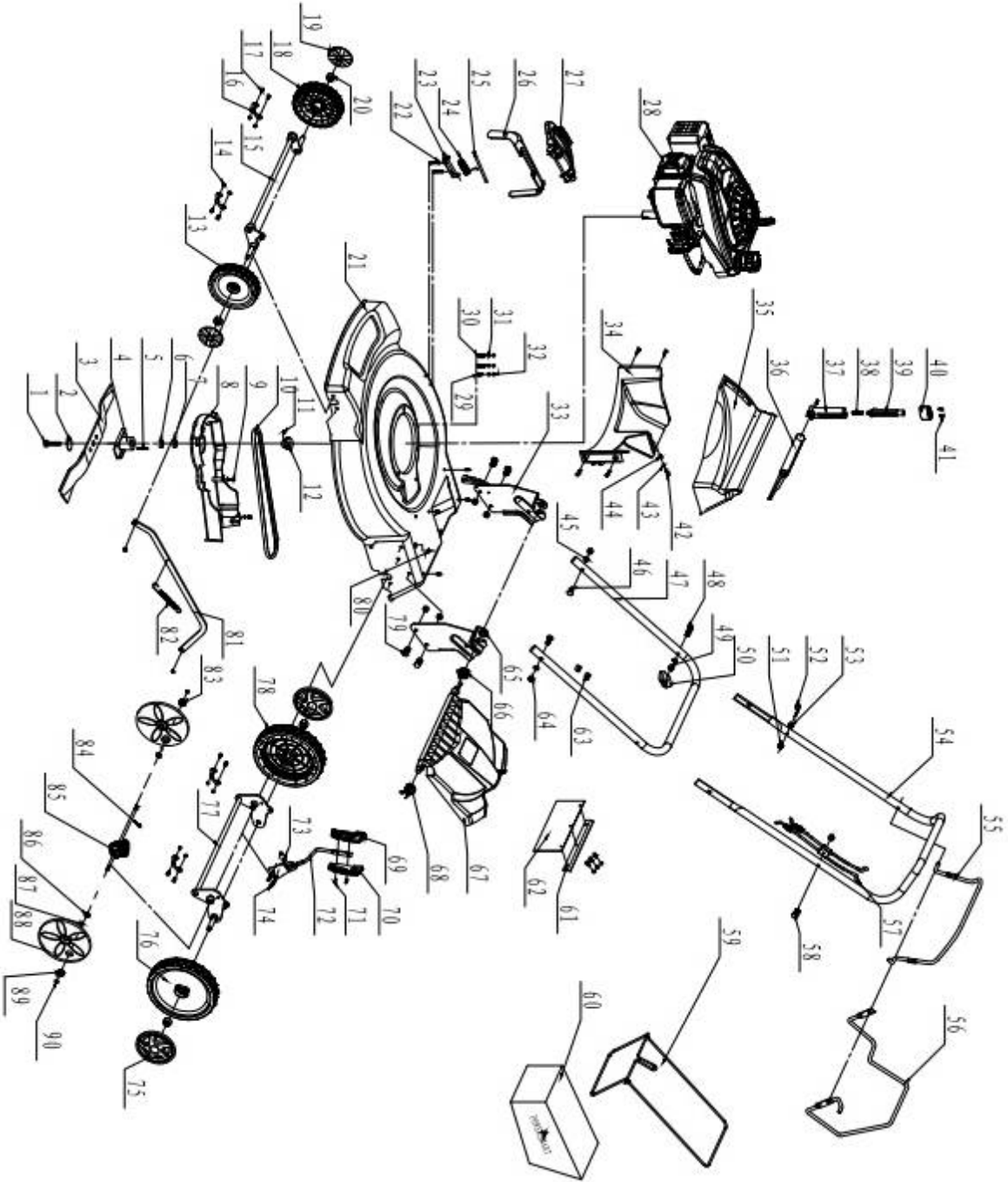

Item	Stock#	Description	QTY	Item	Stock#	Description	QTY
1	303020394	Hex washer screw	1	46	303020146	Hex washer screw	2
2	303043023A	Butterfly washer	1	47	303080284	Lower frame	1
3	303070697	22" New Blade	1	48	303020126	Hex washer screw	2
4	303180653	Adapter	1	49	303030026	nut	2
5	303110023	Flat key	1	50	203020336	Knob	2
6	303160423	Flat washer	1	51	303030025	Cap nut	1
7	303160550A	Spacer bush	1	52	303070633	Cable Hanger	1
8	203050146A	Belt protection cover	1	53	303030065	nut	1
9	303010164	Screw	11	54	303080285	Upper frame	1
10	302040048	Belt	1	55	303160463	Blade control bar	1
11	303020471	Screw	1	56	303160462	Self-propelled drive bar	1
12	303160454	Small pulley	1	57	303200079	Brake Control Cable	1
13	203050157	8" wheel left	1	58	303020308	Hex washer screw	1
14	303030032	Nylon lock nut	14	59	303180656A	Straw Basket	1
15	303180654B	Front wheel Axle	1	60	302120009	Straw Bag	1
16	303070613	Rear Axle keeper	4	61	303070349	Rubber plate	1
17	303020276	Hex washer screw	13	62	302080025A	Rubber	1
18	203050150	8" Wheel Right	1	63	203040007	Cable Clip	2
19	203050261	8" wheel cover	2	64	303030036	Lock nut	2
20	303030077	Flange nut	8	65	303070702A	Left Junction Plate	1
21	303180814A	22" Deck	1	66	303160461	Right Torsional Spring	1
22	303041009	Washer	2	67	203050153	Rear discharge Plate	1
23	303160456	Side Discharge Bracket	1	68	303160464	Left Torsional Spring	1
24	303160455	Torsional Spring	1	69	203010766	Adjusting handle 1	1
25	303160410A	Spring Pin shaft	1	70	203010767	Adjusting handle 2	1
26	203050148A	Side discharge chute	1	71	303010159	Screw	2
27	203050147	Side discharge deflector	1	72	303210016A	Adjusting handle welding	1
28	303190222	EngineLC1P70FC,Recoil start,196CC	1	73	303030032	Nylon lock nut	2
29	303020279	Hex washer screw	1	74	303020339	Hex washer screw	2
30	303020124	Hex washer screw	2	75	203050262	Rear wheel cover 10"	2
31	303041022	Washer	3	76	203010594	Rear wheel left 10"	1
32	303042023	Falt washer	3	77	303180655A	Rear wheel Axle	1
33	303210017B	Right Junction Plate	1	78	203010600	Rear wheel right 10"	1
34	203040018A	Blocking Plate	1	79	303020281	Hex washer screw	4
35	203050154A	Rear discharge cover	1	80	302060025	Cable rubber seal	1
36	203050156A	Rear block plate	1	81	303160457B	go up and down Link	1
37	203050155	rear discharge handle	1	82	303160414	Connecting rod tension	1
38	303160460	handle press spring	1	83	303160470	Drive gear Right	1
39	203010596	Link lever	1	84	303130132	Self-propelled spring	1
40	203010597	Handle cover	1	85	303240335	22" Drive assembly	1
41	303010095	Screw	2	86	303100065	Wheel bearing	2
42	303010185	Screw	1	87	303123017A	cylindrical pin	2
43	303042042	Flat washer	3	88	203050151	Inner damper	2
44	203020339	Spacer bush	1	89	303160471	Drive gear Left	1
45	303043010	Saddle washer	4	90	303050007	closing ring	2

## **TWO (2) YEARS LIMITED WARRANTY**

PowerSmart is committed to building equipment that will provide years of dependable service. Our warranties are consistent with our commitment and dedication to quality.

### **TWO (2) YEARS LIMITED WARRANTY OF POWER SMART PRODUCTS FOR HOME USE.**

PowerSmart ("Seller") warrants to the original purchaser only, that all PowerSmart consumer power tools will be free from defects in material or workmanship for a period of two (2) years from date of purchase. If the tool(s) is used while providing professional or commercial services, the warranty coverage shall be for a maximum of (90) days.

**SELLER'S SOLE OBLIGATION AND YOUR EXCLUSIVE REMEDY** under this Two (2) Years Limited Warranty and, to the extent permitted by law, any warranty or condition implied by law, shall be the re-pair or replacement of parts, without charge, which are defective in material or workmanship and which have not been misused, carelessly handled, or improperly repaired, by person(s) other than an Authorized Seller or Service Center.

Please be aware that normal wear parts are not covered this warranty. This includes drive belts, blades and grass bags. Carburetor issues, and/or other damage found to be the result of stale, contaminated or compromised fuel, is not covered under this limited warranty.

To make a claim under this Limited Warranty, you must return the entire power tool product; transportation prepaid, to PowerSmart. The owner must include a legible copy of the original receipt, which shall list the date of purchase, along with the company's name where the product was purchased.

**THIS LIMITED WARRANTY DOES NOT APPLY TO ANY ACCESSORY ITEMS INCLUDED WITH THE TOOL SUCH AS CIRCULAR SAW BLADES OTHER RELATED ITEMS OR TO ANY REPLACEMENT PARTS LISTED UNDER MAINTENANCE.**

**ANY IMPLIED WARRANTIES SHALL BE LIMITED IN DURATION TO TWO (2) YEARS FROM DATE OF PURCHASE. SOME STATES IN THE U.S. AND SOME CANADIAN PROVINCES DO NOT ALLOW LIMITATIONS ON HOW LONG AN IMPLIED WARRANTY LASTS, SO THE ABOVE LIMITATION MAY NOT APPLY TO YOU.**

**IN NO EVENT SHALL SELLER BE LIABLE FOR ANY INCIDENTAL OR CONSEQUENTIAL DAMAGES (INCLUDING BUT NOT LIMITED TO LIABILITY FOR LOSS OF PROFITS) ARISING FROM THE SALE OR USE OF THIS PRODUCT. SOME STATES IN THE U.S. AND SOME CANADIAN PROVINCES DO NOT ALLOW THE EXCLUSION OR LIMITATION OF INCIDENTAL OR CONSEQUENTIAL DAMAGES, SO THE ABOVE LIMITATION OR EXCLUSION MAY NOT APPLY TO YOU.**

**THIS LIMITED WARRANTY GIVES YOU SPECIFIC LEGAL RIGHTS, AND YOU MAY ALSO HAVE OTHER RIGHTS WHICH VARY FROM STATE TO STATE IN THE U.S., PROVINCE TO PROVINCE IN CANADA AND FROM COUNTRY TO COUNTRY.**

For questions, comments, technical assistance or to order repair parts

Please call toll free at: 1-800-791-9458 (M-F 9am – 5pm CST)

Email: [support@amerisuninc.com](mailto:support@amerisuninc.com)

**PLEASE SAVE ALL OF YOUR ORIGINAL RECEIPTS. THIS WARRANTY IS VOID WITHOUT THEM.**