

OWNER'S MANUAL

**ELECTRIC
INDUCTION
RANGE**

**Read this owner's manual thoroughly before operating the appliance
and keep it handy for reference at all times.**

LSIS3018SS



MFL68881515_01

www.lg.com

Copyright © 2019 - 2020 LG Electronics Inc. All Rights Reserved.

TABLE OF CONTENTS

3 IMPORTANT SAFETY INSTRUCTIONS

10 PRODUCT OVERVIEW

- 10 Parts
- 10 Accessories

11 INSTALLATION

- 11 Installation Overview
- 11 Product Specifications
- 12 Before Installing the Range
- 13 Installing the Range
- 15 Connecting Electricity
- 19 Engaging the Anti-tip Device
- 19 Optional Rear Filler
- 20 Test Run

21 OPERATION

- 21 Control Panel Overview
- 22 Knob Positions
- 23 Changing Oven Settings
 - 23 Clock
 - 23 Lockout
 - 23 Minimum & Maximum Default Settings
 - 24 Timer On/Off
 - 24 Wi-Fi
 - 24 Settings
 - Setting the Hour Mode
 - Setting Convection Auto Conversion
 - Adjusting the Oven Temperature
 - Turning the Preheat Alarm Light On/Off
 - Adjusting the Oven Beeper Volume
 - Selecting Fahrenheit or Celsius
 - Turning the Cooktop Beeper On/Off
- 26 Start Time (Delayed Timed Cook)
- 26 Cook Time (Timed Cook)
- 26 Oven Light
- 27 Using the Cooktop
 - 27 Cooking Areas
 - 27 Benefits of Induction Surface Cooking
 - 27 Induction Cookware
 - 28 Cookware Placement
 - 28 Moving Cookware on the Cooktop
 - 28 Pan Sensing
 - 29 Minimum and Maximum Pan Size
 - 29 Hot Cookware and Residual Heat
 - 29 Home Canning
 - 30 Setting Surface Controls

- 30 Hot Surface Indicator
- 30 Using the Cooking Elements
- 31 The Recommended Surface Cooking Setting
 - 31 Pan Preheat Recommendations
 - 31 Noises during Cooktop Operation
- 32 Power Management
- 32 Warming Zone
- 33 Using the Oven
 - 33 Before Using the Oven
 - 33 Oven Vent
 - 33 Using Oven Racks
 - 33 Bake
 - 34 Convection Mode
 - 35 Recommended Baking and Roasting Guide
 - 36 Broil
 - 37 Recommended Broiling Guide
 - 38 Warm
 - 38 Proof
 - 38 Speed Roast
 - 39 Meat Probe
 - 40 Remote Start
 - 40 Sabbath Mode
- 41 Operating the Warming Drawer
- 42 GlideShut™ Drawer

43 SMART FUNCTIONS

- 43 LG ThinQ Application
- 45 FCC Notice
- 45 FCC RF Radiation Exposure Statement
- 46 Smart Diagnosis™ Feature

47 MAINTENANCE

- 47 Cleaning the Glass-Ceramic Cooktop
- 48 EasyClean®
- 51 Self Clean
- 53 Changing the Oven Light
- 53 Cleaning the Exterior
- 54 Removing and Replacing the Lift-Off Oven Doors and Drawer
- 55 Door Care Instructions

56 TROUBLESHOOTING

- 56 FAQs
- 58 Before Calling for Service

62 LIMITED WARRANTY

IMPORTANT SAFETY INSTRUCTIONS

Read and follow all instructions when using the range to prevent the risk of fire, electric shock, personal injury, or damage. This guide does not cover all possible conditions that may occur. Always contact your service agent or manufacturer about problems that you do not understand.

Download this owner's manual at: <http://www.lg.com>

 This is the safety alert symbol. This symbol alerts you to potential hazards that can result in property damage and/or serious bodily harm or death. All safety messages will follow the safety alert symbol and either the word **WARNING** or **CAUTION**. These words mean:

 **WARNING** - Indicates a hazardous situation which, if not avoided, could result in death or serious injury.

 **CAUTION** - Indicates a hazardous situation which, if not avoided, could result in minor or moderate injury.

ANTI-TIP DEVICE

WARNING

- **TO REDUCE THE RISK OF TIPPING, THE APPLIANCE MUST BE SECURED BY A PROPERLY INSTALLED ANTI-TIP DEVICE. TO CHECK IF THE DEVICE IS INSTALLED PROPERLY, REMOVE THE DRAWER BODY AND VERIFY THAT THE ANTI-TIP DEVICE IS ENGAGED, OR GRASP THE TOP REAR EDGE OF THE RANGE BACK GUARD AND CAREFULLY ATTEMPT TO TILT IT FORWARD.** Refer to the installation section for instructions.
 - It is possible for a child or adult to tip the range and be killed.
- Verify that the anti-tip device has been properly installed and attached to the floor or wall and engaged to the leveling leg of the range.
 - Do not operate the range without the anti-tip device in place and engaged.
 - Never remove the oven legs. The range will not be secured to the anti-tip bracket if the legs are removed.
 - Do not step or sit on the oven door. The range could be tipped and injury might result from spilled hot liquid, food, or the range itself.
 - Do not rest large, heavy items such as whole turkeys on the open oven door. The range could tip forward and cause injury.
 - Reengage the anti-tip device after pulling the range out for cleaning, service, or any other reason.
 - Failure to follow these instructions can result in death or serious burns to children or adults.

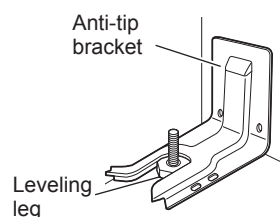

SAFETY PRECAUTIONS

- **DO NOT TOUCH HEATING ELEMENTS OR INTERIOR SURFACES OF OVEN.** Heating elements may be hot even though they are dark in color. Interior surfaces of an oven become hot enough to cause burns. During and after use, do not touch or let clothing or other flammable materials contact heating elements or interior surfaces of oven until they have had sufficient time to cool. Other surfaces, such as oven vent openings and surfaces near these openings, oven doors, and windows of oven doors, also get hot and may cause burns if not cooled.
- **Use care when opening door.** The hot air and steam that escape can cause burns to hands, face and eyes. Let hot air or steam escape from the oven before removing or replacing food in the oven.
- Do not repair or replace any part of the appliance unless specifically recommended in the manual. All other servicing should be performed by a qualified technician.
- Do not use harsh etching, abrasive cleaners or sharp metal scrapers to clean the oven door glass since they can scratch the surface. Scratches may cause the glass to shatter.



WARNING

If the door glass, cooktop glass, surface, or oven heating unit of the range are damaged, discontinue use of the range and call for service.

- Do not operate the oven without the charcoal heater mesh.
- Do not use plastic to cover food. Use foil or oven-safe lids only.
- Do not allow anyone to climb, stand or hang on the door, storage drawer or cooktop. They could damage the range and even tip it over, causing severe personal injury.
- Do not line the oven walls, racks, bottom, or any other part of the oven with aluminum foil or any other material. Doing so will disrupt heat distribution, produce poor baking results and cause permanent damage to the oven interior (aluminum foil will melt to the interior surface of the oven)
- Never attempt to dry a pet in the oven.
- **Never use your appliance for warming or heating the room.**
- Always use pot holders or oven mitts when removing food from the oven or the surface element. Cookware will be hot. **Use only dry pot holders.** Moist or damp pot holders on hot surfaces may result in burns from steam. Do not let the pot holder touch hot heating elements. Do not use a towel or other bulky cloth to remove food.
- **Do not heat unopened food containers.** Pressure in the containers may cause them to burst which may result in injury.
- Before using Wi-Fi functions, open the oven door and make sure the oven is ready for pre-heating.
- If the supply cord is damaged, it must be replaced by the manufacturer, its service agent or similarly qualified persons in order to avoid a hazard.
- If the range is placed on a base, measures must be taken to prevent the appliance from slipping off of the base.
- To avoid the product overheating, do not install a decorative panel on the front of the appliance.
- To eliminate the risk of burns or fire by reaching over heated surface units, cabinet storage space located above the surface units should be avoided. If cabinet storage is to be provided, the risk can be reduced by installing a range hood that projects horizontally a minimum of 5 inches beyond the bottom of the cabinets.

FLAMMABLE MATERIALS

WARNING

Remove all packing materials from the appliance before operating. Keep plastic, clothes, paper, and other flammable materials away from parts of the appliance that may become hot.

- Do not store or use flammable material in the oven or near or on the cooktop. Flammable materials include paper, plastic, pot holders, linens, wall coverings, curtains, and gasoline or other flammable vapors and liquids such as grease or cooking oil. These materials can be ignited when the oven and cooktop are in use.
- **Wear proper apparel.** Do not wear loose-fitting or hanging garments, which may ignite if they contact hot surfaces, and cause severe burns.
- Do not use the oven for drying clothes. Only use the oven for its intended purpose.
- If cabinet storage is provided directly above cooking surface, place items that are not frequently used and can be safely stored in an area subjected to heat. Temperatures may be unsafe for volatile items such as flammable liquids, cleaners or aerosol sprays.

ELECTRICAL SAFETY

- Always disconnect power from the appliance before servicing.
- Do not use aluminum foil or any other material to line the oven bottom. Improper installation of these liners may result in a risk of electric shock or fire.
- Do not allow aluminum foil or the temperature probe to contact heating elements.
- Be sure your range is installed and grounded properly by a qualified installer or service technician.

WARNING

Before replacing the oven light bulb, switch off the electrical power to the oven at the main fuse or circuit breaker panel. Failure to do so can result in severe personal injury, death, or electrical shock.

DEEP FAT FRYER

- Use extreme caution when moving or disposing of hot grease.
- Always heat fat slowly, and watch as it heats.
- If frying combinations of oils and fats, stir them together before heating.
- Use a deep fat thermometer, if possible, to prevent overheating fat beyond the smoking point.
- Use the least possible amount of fat for effective shallow or deep-fat frying. Filling the pan with too much fat can cause spillovers when food is added.

CHILD SAFETY

- Do not touch the hot surface between the bottom of the oven door and the top of the drawer on the front of the oven while the oven is in operation. The surface becomes hot and can cause burns and other injury.
- Do not leave small children unattended near the oven.

⚠ WARNING

Do not leave children alone or unsupervised near the appliance when it is in use or is still hot. Children should never be allowed to sit or stand on any part of the appliance as they could be injured or burned.

⚠ CAUTION

Do not store items of interest to children in cabinets above a range or on the back guard of a range – children climbing on the range to reach items could be seriously injured.

- Never let a child hang on the oven door.
- Do not allow children to crawl into the oven.
- Let hot utensils cool in a safe place, out of reach of small children.
- Children should be supervised to ensure that they do not play with the appliance.

⚠ WARNING

• The appliance and its accessible parts become hot during use. Do not touch heating elements inside the oven. Young children must be continuously supervised if allowed near the appliance.

- This appliance is not intended for use by persons (including children) with reduced physical, sensory or mental capabilities, or lack of experience and knowledge, unless they have been given supervision or instruction concerning use of the appliance by a person responsible for their safety. Do not allow children to play with the appliance. Any cleaning and user maintenance performed by children must be supervised.

GLASS-CERAMIC COOKING SURFACE

- Surface units may be hot even though they are dark in color. Areas near surface units may become hot enough to cause burns. During and after use, **DO NOT TOUCH SURFACE UNITS OR AREAS NEAR UNITS** or let clothing or other flammable materials contact surface units or areas near units until they have had sufficient time to cool. This includes the cooktop and the area above the oven door.
- **Do not cook on a broken cooktop.** If the cooktop is broken, cleaning solutions and spills may penetrate the broken cooktop and create a risk of electric shock. Switch off the appliance to avoid the possibility of electric shock and contact a qualified technician immediately.
- Do not use the glass cooktop surface as a cutting board.
- Do not place or store items that can melt or catch fire on the glass cooktop, even when it is not being used.
- **Choose proper burner size.** For smaller pots and pans, use the smaller heating elements. For larger pots and pans, use the larger heating elements. Select pans that have flat bottoms large enough to cover the heating elements. Using undersized pans exposes a portion of the heating element to direct contact and may result in clothing burning.
- **Glazed cookware.** Only certain types of glass, glass-ceramic, ceramic, earthenware, or other glazed cookware are suitable for range-top service without breaking due to the sudden change in temperature.
- Never cook directly on the glass. Always use cookware.
- Always turn the surface units off before removing cookware. Do not rely on the pan sensor.

**WARNING**

Do not leave fats or oils to heat unattended on the cooktop. Spillovers can result in a fire.

- The cooktop is not intended to be operated by means of an external timer or separate remote-control system.
- **Turn cookware handles inward so they don't extend over adjacent surface units.** This reduces the risk of burns, ignition of flammable materials, and spillage due to unintentional contact with the cookware.
- Immediately clean spills on the cooking area to prevent a tough cleaning chore later.
- Some cleaners can produce dangerous fumes if applied to a hot surface.
- Do not place metallic objects such as knives, forks, spoons, and lids on the cooktop surface, because they can get hot.
- Always place the pan in the center of the surface unit you are cooking on. **Never leave surface units unattended at high heat settings.** Proper contact of cookware to burner also will improve efficiency. Boilovers cause smoking and greasy spills that may catch on fire.
- **Clean cooktop with caution.** Do not use sponges or cloth to wipe spills on a hot cooking area. Use a proper metal scraper. If a wet sponge or cloth is used to wipe spills on a hot cooking area, it can cause steam burns. Some cleaners can produce noxious fumes if applied to a hot surface.
- Do not turn surface units on before placing cookware.
- Do not store heavy items above the cooktop surface that could fall and damage it.
- Do not place aluminum foil or plastic items such as salt and pepper shakers, spoon holders, or plastic wrappings or any other material on the range when it is in use.
- Do not use a steel-wool pad or scrub pad or abrasive cleaning pads. They can scratch the surface.

ENERGY SAVING TIPS

- Multiple-rack cooking saves time and energy. Whenever possible, cook foods requiring the same cooking temperature together in one oven.
- For optimal performance and energy savings, follow the guides on page 36 for proper rack and pan placements.
- Match the size of the cookware to the amount of food being cooked to save energy when heating. Heating ½ quart of water requires more energy in a 3-quart pot than in a 1-quart pot.
- Use cookware with flat bottoms to provide the best contact with the cooktop surface when cooking on the glass-ceramic cooktop.
- Match the size of the cooktop burner or element to the size of the cookware in use. Using a large element for a small pan wastes heating energy, and the exposed surface of the element is a burn or fire hazard.
- Reduce energy use by cleaning light oven soils with the EasyClean® feature instead of self-clean.
- Avoid opening the oven door more than necessary during use. This helps the oven maintain temperature, prevents unnecessary heat loss, and saves on energy use.

SAFETY DURING USE

CAUTION

Supervise all cooking processes. Continuously supervise quick cooking processes.

- During use the appliance becomes hot. Care should be taken to avoid touching heating elements inside the oven.
- Do not touch the oven racks while they are hot.
- Do not block the vent opening.
- Only arrange oven racks when the oven is cool.
- If a rack must be moved while the oven is hot, do not let the pot holder contact the hot heating element in the oven.
- Use caution with the Timed Cook or Delayed Timed Cook features. Use the automatic timer when cooking cured or frozen meats and most fruits and vegetables. Foods that can easily spoil, such as milk, eggs, fish, meat or poultry, should be chilled in the refrigerator first. Even when chilled, they should not stand in the oven for more than 1 hour before cooking begins, and should be removed promptly when cooking is complete. Eating spoiled food can result in sickness from food poisoning.
- Accessible parts may become hot when the grill is in use.
- Do not place food or cookware on the bottom of the oven cavity. Doing so will cause permanent damage to the oven bottom finish.
- Only use the temperature probe recommended for this oven.
- **Do not use water on grease fires.** Should an oven fire occur, leave the oven door closed and turn the oven off. If the fire continues, throw baking soda on the fire or use a fire extinguisher. Do not put water or flour on the fire. Flour may be explosive and water can spread a grease fire and cause personal injury.
- Pull the oven rack to the stop-lock position when loading and unloading food from the oven. This helps prevent burns caused by touching hot surfaces of the door and oven walls.
- Do not use the oven if a heating element develops a glowing spot during use or shows other signs of damage. A glowing spot indicates the heating element may fail and present a potential burn, fire, or shock hazard. Turn the oven off immediately and have the heating element replaced by a qualified service technician.
- When using cooking or roasting bags in the oven, follow the manufacturer's directions.

SAFETY WHEN CLEANING

CAUTION

Remove food, cookware, racks, and accessories from the oven before operating the self-cleaning function. Remove any items placed in the bottom drawer.

- Avoid touching the door, window, or oven vent area during a cleaning cycle, and keep children away from the appliance. These surfaces may get hotter than usual.
- Do not use a steam cleaner to clean the oven.
- Open a window or turn on a ventilation fan or hood before self-cleaning.
- If the oven is heavily soiled with oil, self-clean the oven before using the oven again. The oil could cause a fire.
- Wipe up heavy soil on the bottom of the oven or the excess spillage before using the Self Clean function.
- **Do not use oven cleaners.** Commercial oven cleaner or oven liner protective coating of any kind should not be used in or around any part of the oven.

- Never keep pet birds in the kitchen. The health of birds is extremely sensitive to the fumes released during an oven self-clean cycle. Fumes may be harmful or fatal to birds. Move birds to a well-ventilated room.
- Clean in the self-clean cycle only parts listed in this manual. Before self-cleaning the oven, remove the broiler pan, all oven racks, the meat probe and any utensils or food from the oven.
- Important Instruction. The oven displays an F error code and sounds three long beeps during the self-cleaning process if it malfunctions in the self-clean mode. Switch off the electrical power to the main fuse or breaker and have the oven serviced by a qualified technician.
- It is normal for the cooktop of the range to become hot during a self-clean cycle. Therefore, touching the cooktop during a self-clean cycle should be avoided.
- Never pour cold water over a hot oven for cleaning. Doing so may cause the oven to malfunction.
- Make sure oven lights are cool before cleaning.
- **Do not clean door gasket.** The door gasket is essential for a good seal. Care should be taken not to rub, damage, or move the gasket.
- If there is a fire in the oven during self-clean, turn the oven off and wait for the fire to go out. Do not force the door open. Introduction of fresh air at self-clean temperatures may lead to a burst of flame from the oven. Failure to follow this instruction may result in severe burns.

COOK MEAT AND POULTRY THOROUGHLY

- To protect against food-borne illnesses, cook meat and poultry thoroughly. The USDA has indicated the following as safe minimum internal temperatures for consumption:
 - Ground meats: 160 °F
 - Poultry: 165 °F
 - Beef, veal, pork, or lamb: 145 °F
 - Fish/seafood: 145 °F

PRODUCT OVERVIEW

Parts

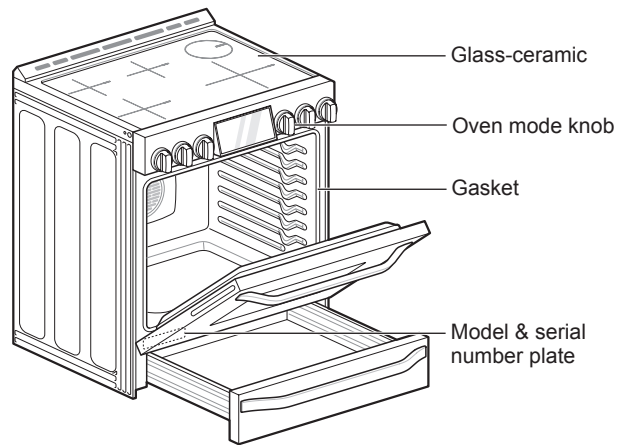
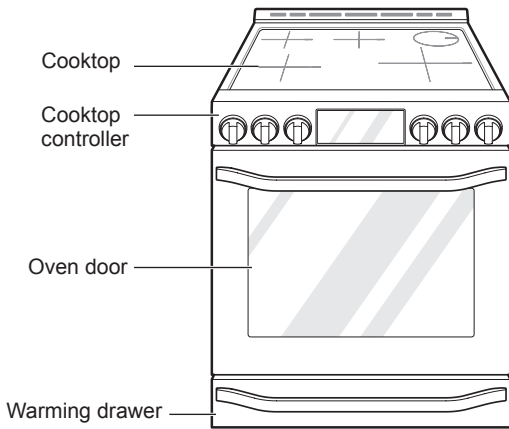

Accessories

Included Accessories



Heavy rack (2ea)

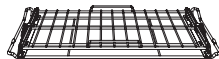

Gliding rack (1ea)

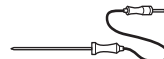

Meat probe (1ea)



Bottom rack (1ea)



Cooktop cleaner (1ea)



Spray bottle (1ea)



Non-scratch scouring pad (1ea)

Optional Accessories



Grid

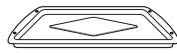

Broiler pan

NOTE

- Contact LG Customer Service at 1-800-243-0000 if any accessories are missing.
- For your safety and for extended product life, only use authorized components.
- The manufacturer is not responsible for product malfunction or accidents caused by the use of separately purchased, unauthorized components or parts.
- The images in this guide may be different from the actual components and accessories, which are subject to change by the manufacturer without prior notice for product improvement purposes.

INSTALLATION

Installation Overview

Please read the following installation instructions first after purchasing this product or transporting it to another location.

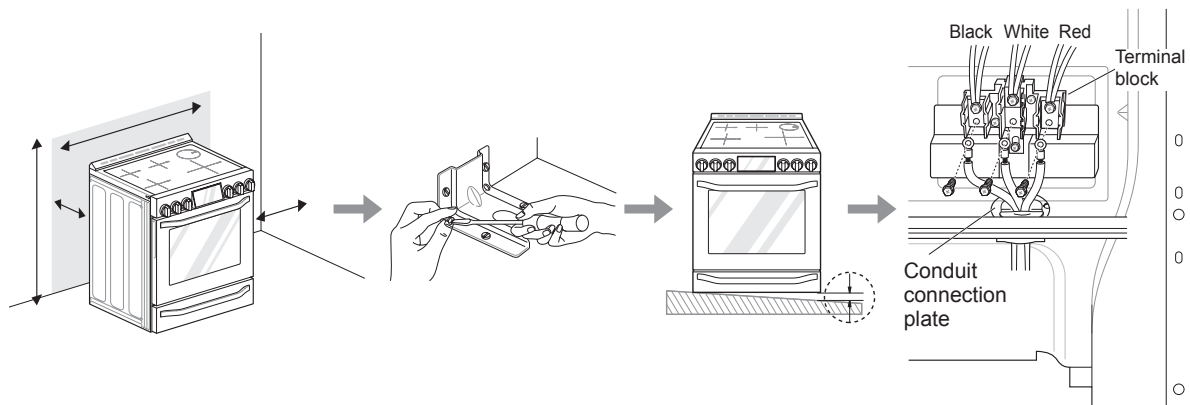

Check and choose the proper location

Install anti-tip device

Level the range

Connect electric range

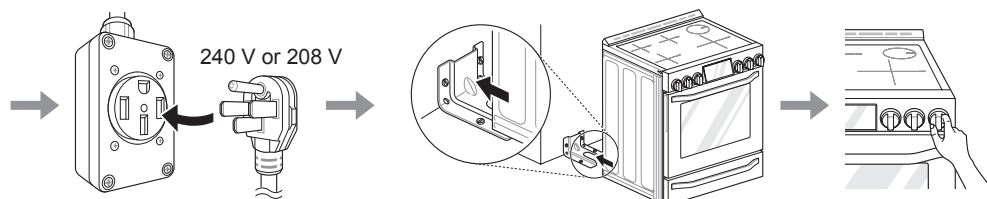

Plug in the power cord

Engage the anti-tip device

Test run

Product Specifications

The appearance and specifications listed in this manual may vary due to constant product improvements.

Oven Range Models	LSIS3018SS
Description	Electric Induction Slide In Oven Range
Electrical requirements	12.1 kW 120/240 VAC or 10.2 kW 120/208 VAC
Exterior Dimensions	29 7/8" (W) x 37 7/8" (H) x 26 1/2" (D) (D with door closed) 75.7 cm (W) x 96 cm (H) x 67.3 cm (D) (D with door closed)
Height to cooking surface	36" (91.4 cm)
Net weight	198.4 lb (90.0 kg)
Total capacity	Total cap.: 6.3 cu. ft.

Before Installing the Range



WARNING

Tip - Over Hazard

A child or adult can tip the range and be killed. Verify the anti-tip bracket has been installed. Ensure the anti-tip bracket is engaged when the range is moved.

Do not operate the range without the anti-tip bracket in place. Failure to follow these instructions can result in death or serious burns to children and adults.



To check that leveling leg is inserted into anti-tip bracket, grasp the top rear edge of the range and carefully attempt to tilt it forward.

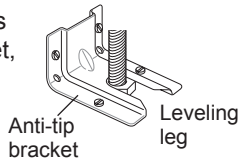

If you did not receive an anti-tip bracket with your purchase, call 1-800-243-0000 to receive one at no cost.



WARNING

- **The information in this manual should be followed exactly.** Failure to do so may result in fire, electrical shock, property damage, personal injury, or death.
- **Wear gloves during the installation procedure.** Failure to do so can result in bodily injury.

Tools Needed



Phillips screwdriver



Flat-blade screwdriver

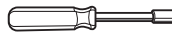

5/16" Nut driver

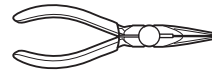

Pliers

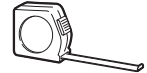

Tape measure



Level



Adjustable wrench



Drill



Safety glasses



Gloves

Parts Provided



Template (1)

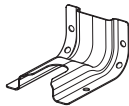

Anti-tip bracket kit (1)

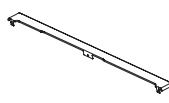

Rear filler (1)

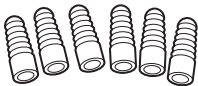

Anchor sleeves (6)



Lag bolts (6)

Parts not Provided



4-Wire cord or
3-Wire cord
(UL approved 40 or 50
AMP)



Strain relief
**(For conduit
Installations only)**

NOTE

- Observe all governing codes and ordinances.
- Have the installer show you the location of the circuit breaker or fuse. Mark it for easy reference.
- As when using any appliance generating heat, there are certain safety precautions you should follow.
- Be sure your range is installed and grounded properly by a qualified installer or service technician.

Installing the Range

Unpacking and Moving the Range

CAUTION

- **Use two or more people to move and install the range. (Excessive Weight Hazard)** Failure to do so can result in back or other injury.
- **Do not use the door handles to push or pull the range during installation or when moving the range out for cleaning or service.** Doing so can result in serious damage to the door of the range.

Remove packing material, tape and any temporary labels from your range before using. Do not remove any warning-type labels, the model and serial number label, or the Tech Sheet that is located on the back of the range.

To remove any remaining tape or glue, rub the area briskly with your thumb. Tape or glue residue can also be easily removed by rubbing a small amount of liquid dish soap over the adhesive with your fingers. Wipe with warm water and dry.

Do not use sharp instruments, rubbing alcohol, flammable fluids, or abrasive cleaners to remove tape or glue. These products can damage the surface of your range.

Your range is heavy and can be installed on soft floor coverings such as cushioned vinyl or carpeting. Use care when moving the range on this type of flooring. Use a belt when moving the range to prevent damaging the floor. Or slide the range onto cardboard or plywood to avoid damaging the floor covering.

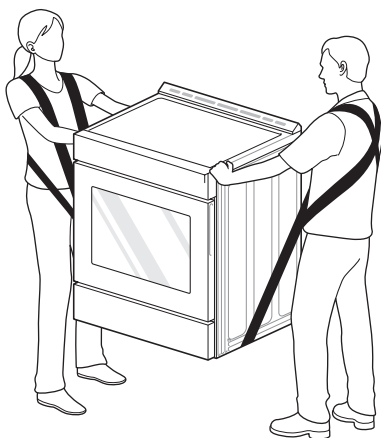

Choosing the Proper Location

CAUTION

- **Avoid placing cabinets above the range.** To minimize the hazard caused by reaching over the open flames of operating burners, install a ventilation hood over the range that projects forward at least five inches beyond the front of the cabinets.
- **Make sure wall covering, countertop and cabinets around the range can withstand the heat (up to 194 °F) generated by the range.** Discoloration, delamination or melting may occur. This range has been designed to comply with the maximum allowable wood cabinet temperature of 194 °F.
- **Before installing the range in an area covered with linoleum or other synthetic floor covering, make sure the floor covering can withstand temperatures of at least 200 °F (93 °C).**
- **Use an insulated pad or 1/4 in. (0.64 cm) plywood under the range if installing the range over carpeting.**

The range should always be plugged into its own individual properly grounded electrical outlet. This prevents overloading house wiring circuits which could cause a fire hazard from overheated wires. It is recommended that a separate circuit serving only this appliance be provided.

Mobile Home - Additional Installation Requirements

The installation of this range must conform to the Manufactured Home Construction and Safety Standard, Title 24 CFR, Part 3280 (formerly the Federal Standard for Mobile Home Construction and Safety, Title 24, HUD Part 280), or when such standard is not applicable, the Standard for Manufactured Home Installations, ANSI A225.1/NFPA 501A or with local codes.

- When this range is installed in a mobile home, it must be secured to the floor during transit. Any method of securing the range is adequate as long as it conforms to the standards listed above.
- A four-wire power supply cord or cable must be used in a mobile home installation.

Dimensions and Clearances

NOTE

Save for the use of the local electrical inspector.

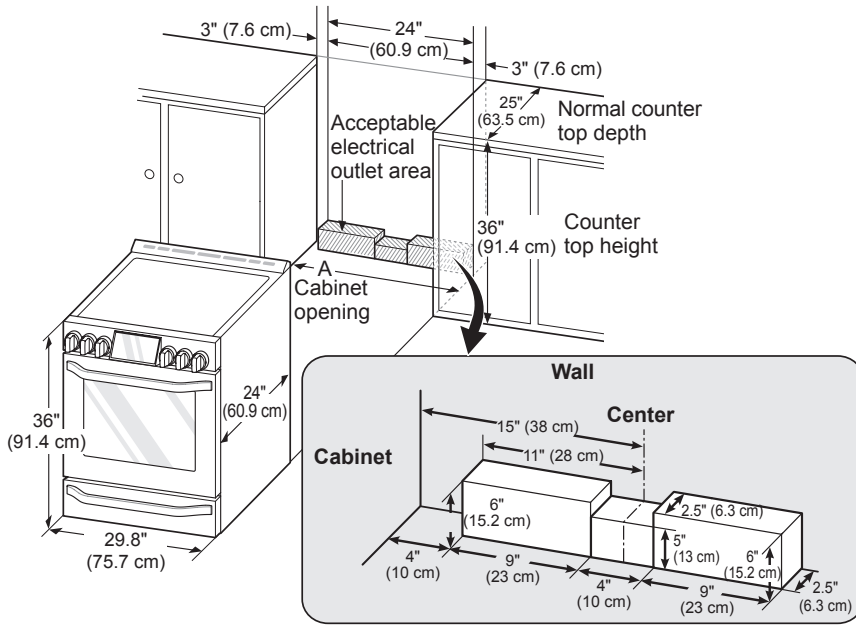

A = 30" (76.2 cm) For U.S.A

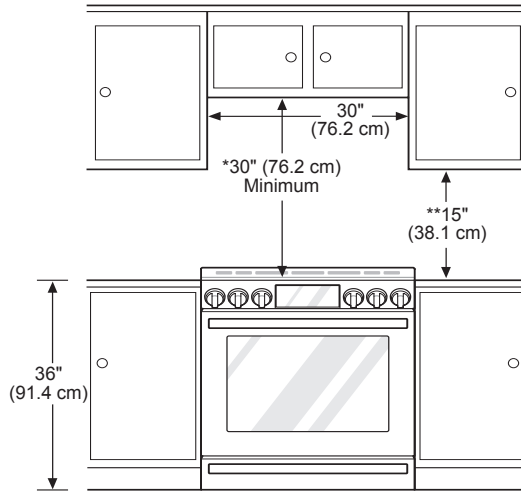

Minimum Dimensions

* 30" (76.2 cm) minimum clearance between the top of the cooking surface and the bottom of an unprotected wood or metal cabinet; or 24" (60.9 cm) minimum when bottom of wood or metal cabinet is protected by not less than 1/4" (6.4 cm) flame retardant millboard covered with not less than no. 28 MSG sheet steel, 0.015" (0.381 mm) stainless steel, 0.024" (0.610 mm) aluminum or 0.020" (0.508 mm) copper.

** 15" (38.1 cm) minimum between countertop and adjacent cabinet bottom.

Installing the Anti-tip Device

WARNING

Tip - Over Hazard

A child or adult can tip the range and be killed. Verify the anti-tip bracket has been installed. Ensure the anti-tip bracket is engaged when the range is moved. Do not operate the range without the anti-tip bracket in place. Failure to follow these instructions can result in death or serious burns to children and adults.



To check that leveling leg is inserted into anti-tip bracket, grasp the top rear edge of the range and carefully attempt to tilt it forward.

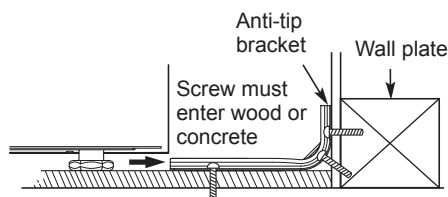
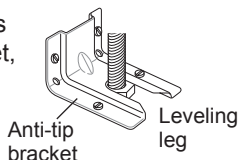

Locate the anti-tip bracket using the template

An anti-tip bracket is packaged with the template. The instructions include necessary information to complete the installation. Read and follow the range installation instruction sheet (template).

Leveling the Range

Level the range by adjusting the leveling legs with a wrench. Extending the legs slightly may also make it easier to insert the rear leg into the anti-tip bracket.

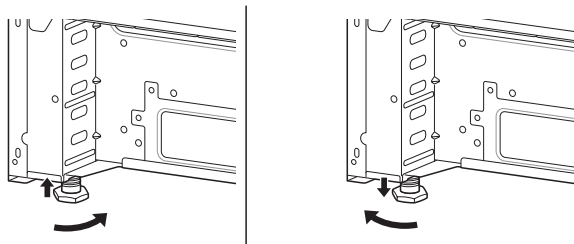

Use a level to check your adjustments. Place the level diagonally on the oven rack, and check each direction for level.

First check direction ①.

Then check direction ②. If the level doesn't show level on the rack, adjust the leveling legs with a wrench.

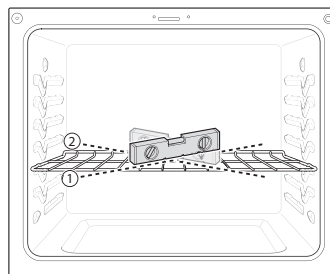

Connecting Electricity

Electrical Requirements

This appliance must be installed and grounded on a branch circuit by a qualified technician in accordance with the National Electrical code ANSI/NFPA NO. 70 - latest edition.

All wiring should conform to Local and NEC codes.

This range requires a single-phase, 3 wire, A.C 120/208 V or 120/240 V 60 Hz electrical system. Use only a 3-conductor or a 4-conductor UL-listed range cord with closed-loop terminals, open-end spade lugs with upturned ends or similar termination. Do not install the power cord without a strain relief.

A range cord rated at 40 amps with 120/240 minimum volt range is required. If a 50 amp range cord is used, it should be marked for use with 1³/₈" diameter connection openings. This appliance may be connected by means of a conduit or power cord. If a conduit is being used, go to page 18 for **3 wire conduit connections** or **4 wire conduit connections**.

WARNING

- Allow 2 to 3 ft (61.0 cm to 91.4 cm) of slack in the line so that the range can be moved if servicing is ever necessary.
- The power supply cord and plug should not be modified. If it will not fit the outlet, have a proper outlet installed by a qualified electrician.
- Using an extension cord to connect the power is prohibited. Connect the power cord and plug directly.
- Electrical ground is required on this appliance.
- Make sure that the power cord is not pinched by the range or heavy objects. Failure to do so can result in serious burns or electrical shock.

Specified power-supply-cord kit rating

Range rating, watts		Specified rating of power supply-cord kit, amperes	Diameter (inches) of Range connection Opening	
			Power cord	Conduit
120/240 volts 3-wire	120/208 volts 3-wire	40 or 50 A	1 3/8"	1 1/8"
8,750 - 16,500	7,801 - 12,500		1 3/4"	1 3/8"
16,501 - 22,500	12,501 - 18,500	50		

3, 4 - Wire electrical wall Receptacle



4 Wire receptacle (14-50R)



3 Wire receptacle (10-50R)

Connecting the Power Cord

The rear access cover must be removed. Loosen the two screws with a screwdriver. The terminal block will then be accessible.

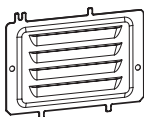

Access cover

Use the cord/conduit connection plate to install the power cord or conduit. Leave the connection plate as installed for power cord installations. Remove the connection plate for conduit installations and use the smaller 1 1/8 in. (2.8 cm) conduit hole instead of the 1 3/8 in. (3.5 cm) power cord hole.

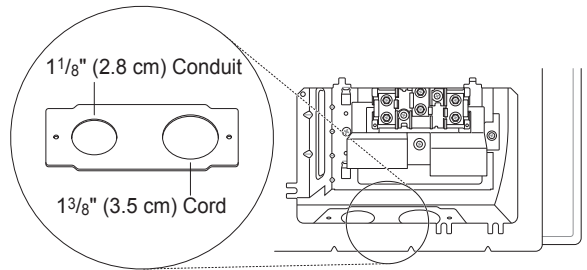

Remove the conduit connection plate

For power cord installations, hook the strain relief over the 1 3/8 in. (3.5 cm) power cord hole located below the rear of the oven. Insert the power cord through the strain relief and tighten it.

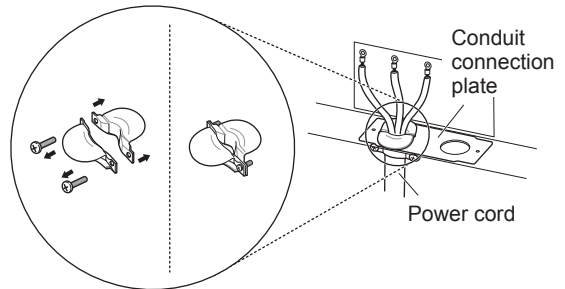

Assembling power cord strain relief at the 1 3/8" opening

For conduit installations, insert the conduit strain relief in the 1 1/8 in. (2.8 cm) conduit hole. Then install the conduit through the body of the strain relief and fasten the strain relief with its ring.

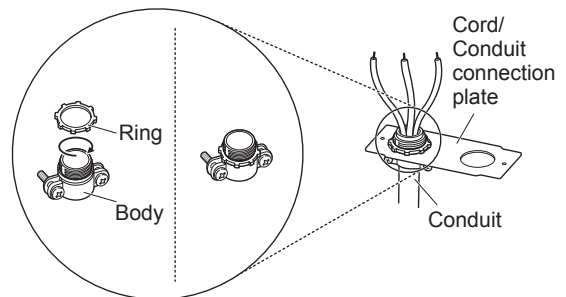

Assembling conduit cord strain relief at the 1 1/8" opening

3-Wire Connection : Power Cord

⚠ WARNING

- The middle (neutral or ground) wire, which is white, of a 3-wire power cord or a 3-wire conduit has to be connected to the middle post of the main terminal block. The remaining two wires of the power cord or conduit have to be connected to the outside posts of the main terminal connection block. Failure to do so can result in electrical shock, severe personal injury or death.

Install the power cord as follows:

For power cord installations, hook the strain relief over the power cord hole ($1\frac{3}{8}$ ") located below the rear of the oven. Insert the power cord through the strain relief and tighten it.

Do not install the power cord without a strain relief.

- 1 Remove the lower 3 screws from the terminal block and retain them.
- 2 Insert the 3 screws through each power cord terminal ring and into the lower terminals of the terminal block. Make sure that the center (neutral) wire, which is white, is connected to the center lower position of the terminal block.
- 3 Tighten the 3 screws securely into the terminal block. Do not remove the ground strap connections.

3-wire connection

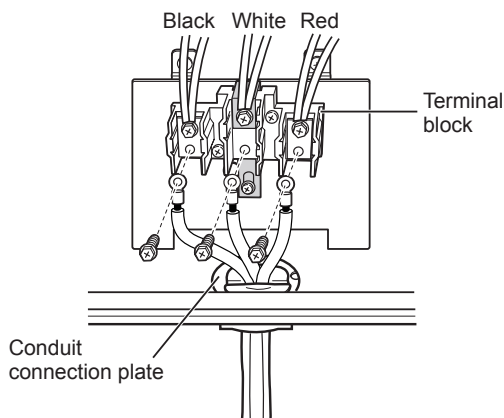

If screws are not tightened securely, it can result in electrical spark and severe personal injury or death.

4-Wire Connection : Power Cord

⚠ WARNING

- Only a 4-conductor power-supply cord kit rated 120/240 volts, 50 amperes and marked for use with ranges with closed-loop connectors or opened spade lugs with upturned ends shall be used. The white middle (neutral) wire of the power cord or 4-wire conduit has to be connected to the middle post of the main terminal block. The other two wires of the power cord or conduit have to be connected to the outside posts of the main terminal connection block. The 4th ground wire (green) must be connected to the frame of the range with the ground screw. Failure to do so can result in electrical shock, severe personal injury or death.

Install the power cord as follows:

Do not install the power cord without a strain relief.

- 1 Remove the lower 3 screws from the terminal block and retain them.
- 2 Remove the ground screw and bend the end of the ground strap up so the slot is over the hole of the center screw removed in step 1.
- 3 Insert the ground screw into the power cord ground wire (green) terminal ring and secure it to the range frame.
- 4 Insert the 3 screws through each power cord terminal ring and into the lower terminals of the terminal block. Make sure that the white center (neutral) wire is connected to the center lower position of the terminal block.
- 5 Tighten the 3 screws securely into the terminal block. The center screw now attaches the bent up ground strap to the block.

4-wire connection

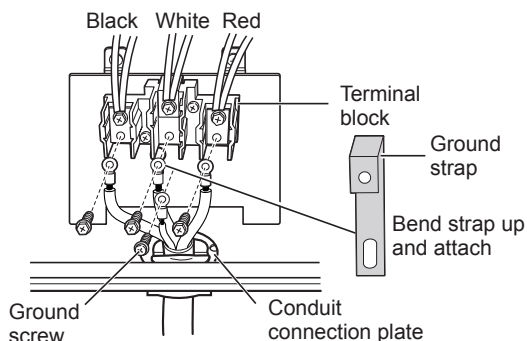

If screws are not tightened securely, it can result in electrical spark and severe personal injury or death.

3-Wire Connection: Conduit

Install the conduit as follows:

Remove the conduit connection plate from the rear of the oven and rotate it. The conduit hole (1 1/8") must be used.

First, prepare the conduit wires as shown below.

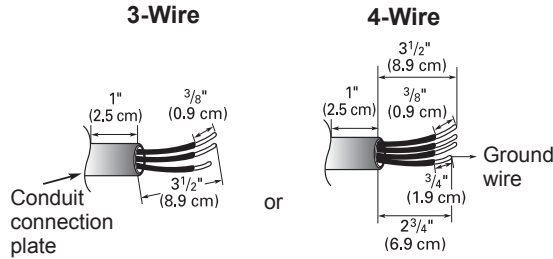

Second, install the conduit strain relief.

For conduit installations, purchase a strain relief and insert it in the 1 1/8 in. (2.8 cm) conduit hole. Then install the conduit through the body of the strain relief and fasten the strain relief with its ring. Reinstall the bracket.

For conduit connections:

If the wire in the conduit is copper it must be 8 or 10 AWG wiring.

If the wire in the conduit is aluminum it must be 6 or 8 AWG wiring.

- 1 Loosen the lower 3 screws from the terminal block.
- 2 Insert the bare wire (white/neutral) end through the center terminal block opening. Do not remove the ground strap connections.
- 3 Insert the two side bare wire ends into the lower left and the lower right terminal block openings. Tighten the 3 screws securely into the terminal block. (approximately 35 - 50 IN-LB)

3-wire connection

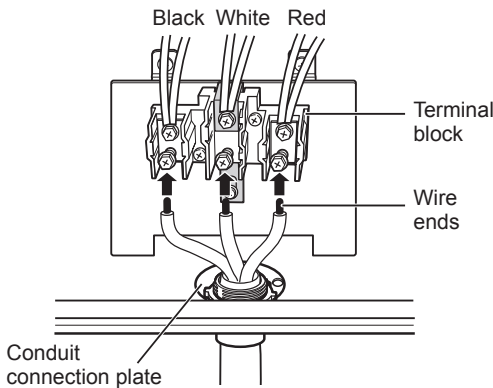

If screws are not tightened securely, it can result in electrical spark and severe personal injury or death.

4-Wire Connection: Conduit

WARNING

- The white middle (neutral) wire of the power cord or 4-wire conduit has to be connected to the middle post of the main terminal block. The other two wires of the power cord or conduit have to be connected to the outside posts of the main terminal connection block. The 4th ground wire (green) must be connected to the frame of the range with the ground screw. Failure to do so can result in electrical shock, severe personal injury or death.

- 1 Follow the instructions for installing the conduit under 3-Wire Connection: Conduit until the strain relief and bracket are installed. Do not install the conduit without a strain relief.
- 2 Loosen the 2 lower left and right screws from the terminal block. Remove the lower 2 center screws. Do not discard any screws.
- 3 Remove the ground screw and bend the end of the ground strap up so the slot is over the hole of the center screw removed in step 1.
- 4 Attach the ground (green) bare wire end to the range frame and secure it in place with the ground screw.
- 5 Insert the bare wire (white/neutral) end through the center terminal block opening. The center screw now attaches the bent up ground strap to the block.
- 6 Insert the two side bare wire ends into the left and the right terminal block openings. Tighten the 3 screws securely into the terminal block. (approximately 35 - 50 IN-LB)

4-wire connection

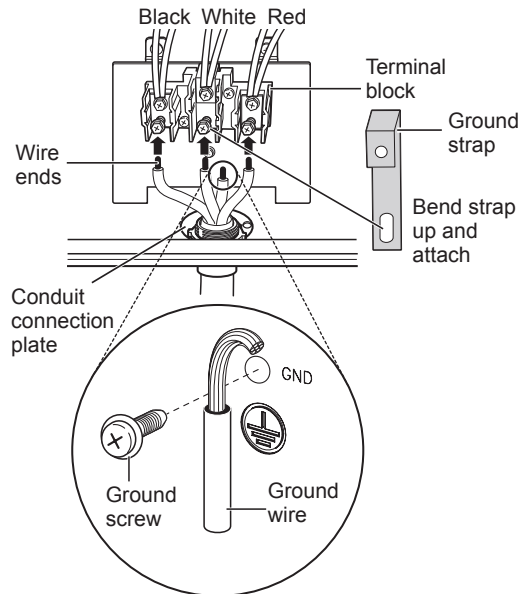

If screws are not tightened securely, it can result in electrical spark and severe personal injury or death.

Engaging the Anti-tip Device

- Move the range close enough to the opening to plug into the receptacle.
- Slide the range into position ensuring that the back leg slides under the anti-tip bracket. The range should sit flush against the back wall when properly installed.
- Carefully attempt to tip the range forward to ensure that the anti-tip bracket is engaged properly. If properly installed, the anti-tip bracket will prevent the range from being tipped. If the range can be tipped, reinstall the range until the anti-tip bracket is properly installed and the range will not tip forward.
- Turn on electrical power. Check the range for proper operation.

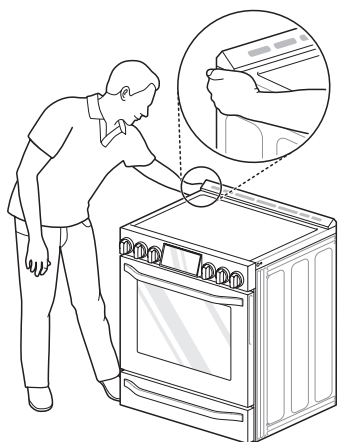

Optional Rear Filler

If the counter does not bridge the opening at the rear wall the rear filler kit, that is provided with the slide in range, will be needed.

NOTE

If the countertop depth is greater than 25" there will be a gap between the filler kit and the back wall.

If the countertop depth is less than 24", the control panel will not sit flush with the countertop.

Installing the Rear Filler

- 1 Using a screwdriver, remove the three screws holding the rear bracket in place.

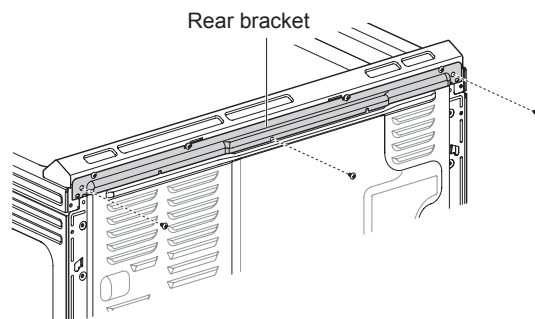

- 2 Attach the rear bracket and filler assembly as shown, using the three screws removed in step 1.

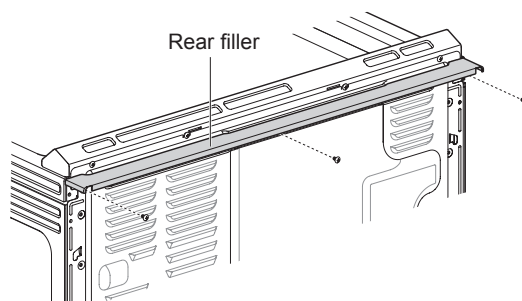

Test Run

Check if the range is properly installed and run a test cycle.

- 1** Before using the cooktop for the first time, clean it with a ceramic cooktop cleaner. This helps protect the top and makes cleanup easier.
- 2** Turn the oven mode knob to the **Off** position to start test.
- 3** Fill an induction-capable pot with water and place it on a surface element. Turn on the surface element. The LED bar should show the setting and the water should heat. The LED bar should not fluctuate. Repeat for all surface elements.
- 4** After checking all the surface heating elements, check the locking system by pressing **Probe** for three seconds. The oven door should lock and the cooktop should not operate while the Lockout function is turned on. Press **Probe** for three seconds to disable Lockout.
- 5** Now check the oven's operation. Turn the oven mode knob to select the **Bake** mode. 350 °F appears in the display. Press **Start**.
- 6** The oven should finish preheating in 15 minutes, and the convection fan should operate while the oven is preheating.
- 7** After checking the oven's operation, turn the temperature up to 450 °F and leave the oven on for at least an hour to help remove any oil which might cause smoke and odors when first using the oven.

NOTE

Smoke may come out of the range when it is first used.

OPERATION

Control Panel Overview

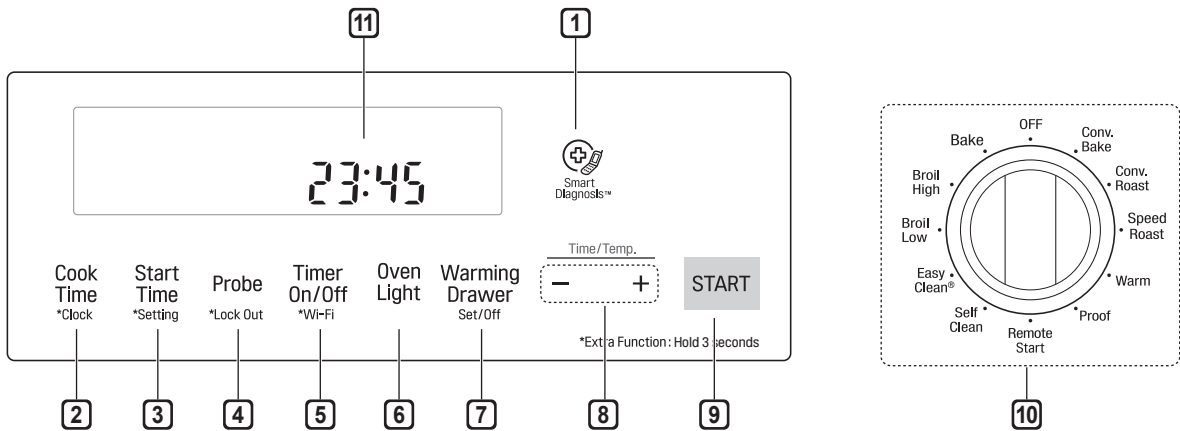

1 Smart Diagnosis™

- Use during the Smart Diagnosis feature.

2 Cook Time / Clock

- Press the button to set the desired amount of time for food to cook. The oven shuts off when the set cooking time runs out.
- Press and hold button for three seconds to set the time of day.

3 Start Time / Setting

- Press the button to set the delayed timed cook. The oven starts at the set time.
- Press and hold button for three seconds to select and adjust oven settings.

4 Probe / Lock Out

- Press the button to select Probe function.
- Press and hold button for three seconds to lock or unlock the door and control panel.

5 Timer On/Off / *Wi-Fi

Press the button to set or cancel timer on oven. Press and hold button for three seconds to connect the Wi-Fi.

To disconnect the appliance from the network, delete it from the registered appliances in the app.

6 Oven Light

Press the button to turn oven light on or off.

7 Warming Drawer

Press the button to select the warming drawer function.

8 - /+

Press the plus button (+) to increase cooking time or oven temperature. Press the minus button (-) to decrease cooking time or oven temperature.

9 Start

Press the button to start all oven features.

10 Oven Mode Knob

Turn the knob to select oven operating mode.

11 Flashing Clock

If the colon in the clock display flashes, press **Cook Time** for three seconds and reset the clock, or press any key to stop the flashing.

Knob Positions

After cleaning the oven knobs, make sure to replace each knob in the correct position. Failure to do so can result in improper operation of the burners.

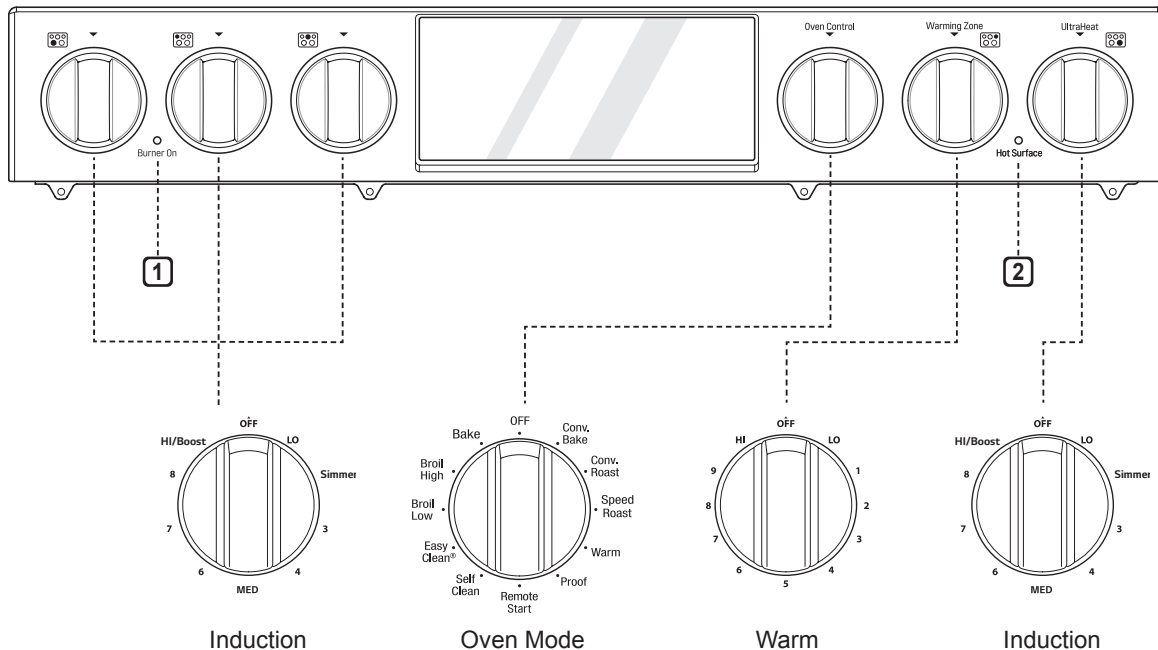

1 Burner On Indicator

The **Burner On** indicator light turns on when the knob is turned even if the cooktop element does not operate.

2 Hot Surface Indicator

The hot surface indicator light glows as long as any surface cooking area is too hot to touch. It remains on after the element is turned off and until the surface has cooled to approximately 130 °F.

Changing Oven Settings

Clock

The clock must be set to the correct time of day in order for the automatic oven timing functions to work properly.



- 1 Set the oven mode knob to the **Off** position.
- 2 Press and hold **Cook Time** for three seconds. **CLO** shows in the display.
- 3 Press **plus(+)** or **minus(-)** to select the desired time. **Plus(+)** to increase the time and **minus(-)** to decrease the time.
- 4 Press **Start** to enter the time and start the clock.

NOTE

- The time of day cannot be changed during a timed baking or self-clean cycle.
- If no other keys are pressed within 25 seconds of pressing **Clock**, the display reverts to the original setting.
- If the display colon in the clock is blinking, you may have experienced a power failure. Reset the time.

Lockout

The Lockout feature automatically locks the oven door and prevents most oven from being turned on. It does not disable the timer and the interior oven light.

- 1 Set the oven mode knob to the **Off** position.
- 2 Press and hold **Probe/Lockout** for three seconds.
- 3 The lock melody sounds, **Loc** appears in the display and the lock icon  blinks in the display.
- 4 Once the oven door is locked, the lock  indicator stops blinking and remains on.
- 5 To deactivate the Lockout feature, press and hold **Probe/Lockout** for three seconds. The unlock melody sounds and the door and the controls unlock.

Minimum & Maximum Default Settings

All of the features listed have a minimum and a maximum time or temperature setting that may be entered into the control. An entry acceptance beep sounds each time a control key is pressed.

An entry error tone (two short tones) sounds if the entry of the temperature or time is below the minimum or above the maximum setting for the feature.

Feature		min. Temp. / Time	max. Temp. / Time	Default
Clock	12 Hr.	1:00 Hr. / min.	12:59 Hr. / min.	
	24 Hr.	0:00 Hr. / min.	23:59 Hr. / min.	
Timer	12 Hr.	0:10 sec.	11:59 Hr. / min.	
	24 Hr.	0:10 sec.	11:59 Hr. / min.	
Cook Time	12 Hr.	0:01 min.	11:59 Hr. / min.	
	24 Hr.	0:01 min.	11:59 Hr. / min.	
Conv. Bake		300 °F / 150 °C	550 °F / 285 °C	350 °F (*325 °F) / 12 Hr.
Conv. Roast		300 °F / 150 °C	550 °F / 285 °C	350 °F (*325 °F) / 12 Hr.
Broil		Lo 400 °F	Hi 520 °F	Hi / 3 Hr.
Bake		170 °F / 80 °C	550 °F / 285 °C	350 °F / 12 Hr.
Proof		0:01 min.	11:59 Hr. / min.	12 Hr.
Speed Roast				12 Hr.
Warm				3 Hr.
Self Clean		3 Hr.	5 Hr.	4 Hr.
Probe		80 °F / 27 °C	210 °F / 100 °C	150 °F / 65 °C
EasyClean®				10 min.

* Using Auto Conversion

- Default cook mode times are without setting cook time.

Timer On/Off

The Timer feature serves as an extra timer in the kitchen that beeps when the set time has run out. It does not start or stop cooking.

The Timer feature can be used during any of the oven control functions.

Setting the Timer

- 1 Set the oven mode knob to the **Off** position.
- 2 Press **Timer On/Off**. 0:00 with **HR** inside it appears and **Timer** flashes in the display.
- 3 Press **plus(+)** or **minus(-)** to set the desired time. **Plus(+)** increases the time and **minus(-)** decreases the time.
- 4 Press **Timer On/Off** or **Start** to start the Timer. The remaining time countdown appears in the display.

NOTE

If **Timer On/Off** is pressed again after the timer has started, the timer function is canceled.

- 5 When the set time runs out, **End** shows in the display. The indicator tones sound every 15 seconds until **Timer On/Off** is pressed.

NOTE

- If the remaining time is not in the display, recall the remaining time by pressing **Timer On/Off**.
- Press **Timer On/Off** twice to set the time in minutes and seconds.
- Press **Timer On/Off** once to set the time in hours and minutes.

Canceling the Timer

- 1 Press **Timer On/Off** once.
The display returns to the time of day.

Wi-Fi

The Wi-Fi button is used to connect the appliance to a home Wi-Fi network.

- 1 Set the oven mode knob to the **Off** position.
- 2 Press and hold **Timer On/Off** for 3 seconds.
- 3 The power on chime sounds, **SEt** appears in the display, and the Wi-Fi icon (📶) blinks.
- 4 Register the appliance on the Wi-Fi network using the smart phone app.
- 5 To disconnect the appliance from the network, delete it from the registered appliances in the app.

NOTE

See the Smart Functions section in the owner's manual for more details.

Settings

Set the oven mode knob to the **Off** position. Press and hold **Start Time** for three seconds. Then press the **Start Time** key repeatedly to toggle through and change oven settings.

The **Setting** key allows you to:

- set the hour mode on the clock (12 or 24 hours)
- enable/disable convection auto conversion
- adjust the oven temperature
- activate/deactivate the preheating alarm light
- set the beeper volume
- switch the temperature scale between Fahrenheit and Celsius
- activate/deactivate the cooktop beeper

Setting the Hour Mode

The control is set to use a 12-hour clock. To reset the clock to 24-hour mode, follow the steps below.

- 1 Set the oven mode knob to the **Off** position.
- 2 Press and hold **Start Time** for 3 seconds.
- 3 Press **plus(+)** or **minus(-)** to set the desired hour mode on the clock.
- 4 Press **Start** to accept the desired change.

Setting Convection Auto Conversion

When **Conv. Bake** and **Conv. Roast** are selected, Convection Auto Conversion automatically converts the standard recipe temperature entered to a convection temperature by subtracting 25 °F / 14 °C. This auto-converted temperature shows on the display. For example, select **Conv. Bake**, enter 350 °F, and 325 °F shows on the display after preheat.

Convection Auto Conversion is enabled by default. To change the setting, follow these instructions.

- 1 Set the oven mode knob to the **Off** position.
- 2 Press and hold **Start Time** for 3 seconds. Then press **Start Time** repeatedly until "A U T O" appears in the display.
- 3 Press **plus(+)** or **minus(-)** to turn the feature on/off.
- 4 Press **Start** to accept the change.

Adjusting the Oven Temperature

Your new oven may cook differently from the one it replaced. Use your new oven for a few weeks to become more familiar with it before changing the temperature settings. If after familiarizing yourself with the new oven, you still think that it is too hot or too cold, you can adjust the oven temperature yourself.

NOTE

To begin, either raise or lower the thermostat 15 °F (8 °C). Try the oven with the new setting. If the oven still needs adjustment, raise or lower the thermostat again, using the first adjustment as a gauge. For example, if the adjustment was too much, raise or lower the thermostat 10 °F (5 °C). If the adjustment was not enough, raise or lower the thermostat 20 °F (12 °C). Proceed in this way until the oven is adjusted to your satisfaction.

- 1 Set the oven mode knob to the **Off** position.
- 2 Press and hold **Start Time** for three seconds. Then press **Start Time** repeatedly until “**⏲ 11**” appears in the display.
- 3 To increase the temperature, press **plus (+)** until the desired amount appears in the display.
To decrease the temperature, press **minus (-)** until the desired amount appears in the display.
- 4 Press **Start** to accept the change.

NOTE

- This adjustment does not affect the broiling or Self Clean temperatures. The adjustment is retained in memory after a power failure. The oven temperature can be increased (+) or decreased (-) as much as 35 °F or 19 °C.
- Once the temperature is increased or decreased, the display shows the adjusted temperature until it readjusts.

Turning the Preheat Alarm Light On/Off

When the oven reaches its set-temperature, the preheating alarm light flashes 5 times or until the oven door is opened.

- 1 Set the oven mode knob to the **Off** position.
- 2 Press and hold **Start Time** for three seconds. Then press **Start Time** repeatedly until “**Pr ⏲**” appears in the display.
- 3 Press **plus(+)** or **minus(-)** to turn the light on/off.
- 4 Press **Start** to accept the change.

Adjusting the Oven Beeper Volume

- 1 Set the oven mode knob to the **Off** position.
- 2 Press and hold **Start Time** for three seconds. Then press **Start Time** repeatedly until “**⏲ 1P**” appears in the display.
- 3 Press **plus(+)** or **minus(-)** to select the desired volume.
- 4 Press **Start** to accept the change.

Selecting Fahrenheit or Celsius

Set the oven temperature display to show either Fahrenheit (°F) or Celsius (°C) units. The oven defaults to Fahrenheit unless changed by the user.

- 1 Set the oven mode knob to the **Off** position.
- 2 Press and hold **Start Time** for three seconds. Then press **Start Time** repeatedly until “**⏲ 1F**” appears in the display.
- 3 Press **plus(+)** or **minus(-)** to select F(Fahrenheit) or C(Centigrade).
- 4 Press **Start** to accept the change.

Turning the Cooktop Beeper On/Off

- 1 Set the oven mode knob to the **Off** position
- 2 Press and hold **Start Time** for three seconds. Then press **Start Time** repeatedly until “**⏲ 0P**” appears in the display.
- 3 Press **plus(+)** or **minus(-)** to turn the beep on/off.
- 4 Press **Start** to accept the change.

Start Time (Delayed Timed Cook)

The automatic timer of the Delayed Timed Cook function turns the oven on and off at the time you select. This feature can be used with the **Bake**, **Conv. Bake** and **Conv. Roast** modes.

Setting a Delayed Timed Cook

For example, to bake at 300 °F and delay the start of baking until 4 h 30 m, first set the clock for the correct time of day.

- 1 Turn the oven mode knob to select the **Bake** mode. 350 °F appears in the display.
- 2 Set the temperature: press **minus(-)** until 300 °F appears in the display.
- 3 Press **Cook Time** and press plus (+) or minus (-) to set the baking time.
- 4 Press **Start Time**.
- 5 Set the start time: press **plus(+)** until ^{HR}4:30 appears in the display.
- 6 Press **Start**. A short beep sounds and **Timed Delay** and the start time appear in the display. The oven begins baking at the set start time.

NOTE

- To cancel the Delayed Timed Cook function, turn the oven mode knob to the **Off** position.
- To change the cooking time, repeat step 3 and press **Start**.
- If the oven clock is set as a 12-hour clock, you can delay the cook time for 12 hours. If the oven clock is set as a 24-hour clock, you can delay the cook time for 24 hours.

The oven will continue to cook for the set amount of time and then turn off automatically. When the cooking time has elapsed:

- **End** and the time of day show in the display.
- The cook end indicator tone sounds every 60 seconds until the oven mode knob is turned to the **Off** position.

CAUTION

- Use the automatic timer when cooking cured or frozen meats and most fruits and vegetables. Foods that can easily spoil, such as milk, eggs, fish, meat or poultry, should be chilled in the refrigerator. Even when chilled, they should not stand in the oven for more than 1 hour before cooking begins, and should be removed promptly when cooking is completed.
- Eating spoiled food can result in sickness from food poisoning.

Cook Time (Timed Cook)

Set the oven to cook for a specific length of time using the Timed Cook feature. This feature can only be used with the **Bake**, **Conv. Bake** and **Conv. Roast** modes.

Setting the Cook Time Function

For example, to bake at 300 °F for 30 minutes, first set the clock to the correct time of day.

- 1 Turn the oven mode knob to select the **Bake** mode. 350 °F appears in the display.
- 2 Set the oven temperature. For this example, press **minus(-)** until 300 °F appears in the display.
- 3 Press **Cook Time**. **Timed** flashes in the display. **Bake**, 0:00 and 300 °F appear in the display.
- 4 Set the baking time: press **plus(+)** until 30:00 appears in the display. The baking time can be set for any amount of time between 1 minute and 11 hours and 59 minutes.
- 5 Press **Start**.

The oven will continue to cook for the set amount of time and then turn off automatically. When the cooking time has elapsed:

- **End** and the time of day show in the display.
- The cook end indicator tone sounds every 60 seconds until the oven mode knob is turned to the **Off** position.

Changing the Cook Time during Cooking

For example, to change the cook time from 30 minutes to 1 hour and 30 minutes, do the following.

- 1 Press **Cook Time**.
- 2 Change the baking time: press **plus(+)** until 1 hour and 30 minutes appears in the display.
- 3 Press **Start** to accept the change.

Oven Light

The interior oven light automatically turns on when the door is opened. Press **Oven Light** to manually turn on/off the oven light.

NOTE

The oven light cannot be turned on if the Self Clean function is active.

Using the Cooktop

Cooking Areas

The cooktop is equipped with four induction cooking elements of different sizes and a radiant heat warming zone. The wattage ratings below are maximum outputs. The second rating is the maximum output for Boost mode.

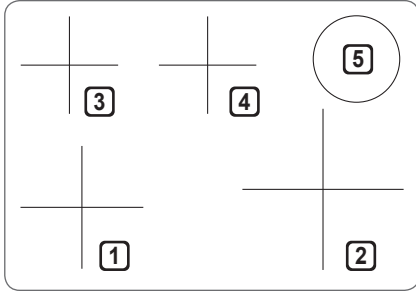

- 1 Induction left front cooking element:
8", 2100 W / 3200 W (240 V)
- 2 Induction right front cooking element:
11", 2400 W / 4000 W (240 V)
- 3 Induction left rear cooking element:
6", 1300 W / 1800 W (240 V)
- 4 Induction center rear cooking element:
6", 1300 W / 1800 W (240 V)
- 5 Warming zone

There are LED displays under each induction cooking element which adjust to show the power level when the element is used.

Benefits of Induction Surface Cooking

Speed and Efficiency

Induction cooking elements heat faster and use less energy. Induction power levels quickly boil liquids and are efficient when simmering.

A Cooler Cooktop

Whether induction cooking elements are turned on or off, they remain cooler than radiant elements. Virtually no heat is wasted because the heat begins with the presence of cookware.

Easy Cleanups

Cooler cooking elements make for easier cleaning. Spills resist sticking or burning so they wipe up easily.

Pan Size Detection

A sensor automatically detects and adapts the induction cooking element to the pan size in use for more consistent, even cooking.

Greater Responsiveness

Induction cooking elements are more responsive than their electric or gas counterparts because only the pan heats. Induction elements heat more easily and are just as responsive when reducing temperatures to a simmer.

Induction Cookware

NOTE

Before using the induction cooking elements, carefully read and follow these cookware recommendations and the instructions in the pan sensing sections.

When purchasing pans for use on the induction cooktop, look for cookware identified by the manufacturer as "induction ready" or "induction capable", or that is marked by the manufacturer as specifically designed for induction cooking.

The base material of the cookware must be magnetic for the cooking elements to activate. Use a magnet to check if the cookware base material is suitable. If the magnet sticks to the bottom of the cookware, the cookware can be used for induction cooking.

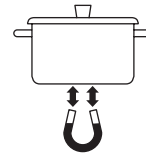

For the best possible surface cooking results, use only high-quality, heavy gauge steel cookware on the induction cooking elements. Follow manufacturer's recommendations when using induction cookware.

Induction Cookware Types

The three most common induction cookware types available are stainless steel, cast iron, and porcelain-enamel-coated metals.

- **Stainless Steel** is generally excellent for induction cooking. It is durable, easy to clean, and resists staining.

NOTE

Not all stainless steel cookware is magnetic; stainless steel is not always suitable for induction cooking.

- **Cast iron** cooks evenly and is also good for induction cooking. Do not slide cast iron cookware on the cooktop; cast iron cookware with a rough surface will scratch the ceramic cooktop.
- **Porcelain-enamel-coated metals** have variable heating characteristics depending on the quality of the base metal. Make sure the porcelain-enamel coating is smooth to avoid scratching the ceramic cooktop.

Cookware Placement

Use the proper cookware and place it correctly on the cooktop. One or more of the cooking elements will not heat if any of the incorrect conditions shown is detected by the sensors located below the ceramic cooktop surface. Correct the problem before attempting to use the cooktop.

Correct

- Cookware is centered correctly on surface of cooking element.
- Pan has flat bottom and straight sides.
- Pan size meets or exceeds the recommended minimum size for the cooking element.
- Pan rests completely on the cooktop surface.
- Pan is properly balanced.

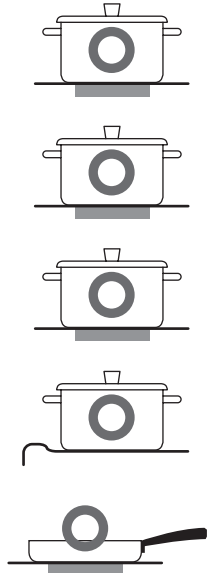

Incorrect

- Cookware is not centered on surface of cooking element.
- Pan has curved or warped bottom or sides.
- Pan does not meet the minimum size required for the cooking element used.
- Pan bottom rests on cooktop trim or does not rest completely on the cooktop surface.
- Pan is unbalanced by heavy handle.

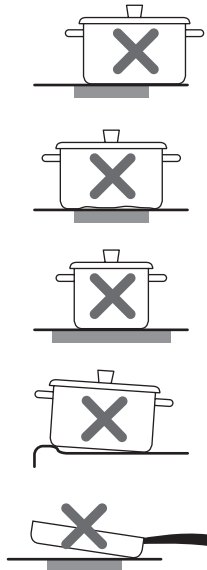

Moving Cookware on the Cooktop

Always use heavier gauge, high-quality cookware on the cooking elements and do not slide it on the ceramic cooktop surface. Even high-quality cookware can scratch the cooktop surface.

NOTE

- Always lift cookware before moving it on the ceramic glass surface. Any cookware that has a rough or dirty bottom can mark and scratch the cooktop surface. Always start with clean cookware.
- Do not allow aluminum foil or any material that can melt to make contact with the ceramic glass cooktop. If these materials melt on the cooktop they may damage the ceramic glass surface.

Sliding any type of cookware over the surface will scratch the cooktop over time. Scratches will make cleaning the ceramic cooktop difficult and degrade the appearance of the cooktop.

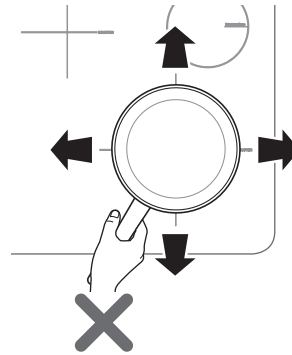

Pan Sensing

The cooking-element sensors located below the cooktop surface require certain cookware conditions to be met before the induction cooking elements can operate.

The cooking zone LED bar may display a pan sensing error message. If a cooking element is activated and no cookware is detected, the affected induction cooking zone LED bar will fluctuate. If the cookware does not meet the correct conditions, the cooking zone may not heat.



If the problem is not corrected, the affected cooking element will automatically deactivate after one minute.

Minimum and Maximum Pan Size

There are four cooking elements on the induction cooktop. Each element requires a minimum pan size to be used effectively. The inner ring of each cooking element is a guide to the minimum pan size. The bottom of the pan must fully cover the inner ring for proper cooking to occur.

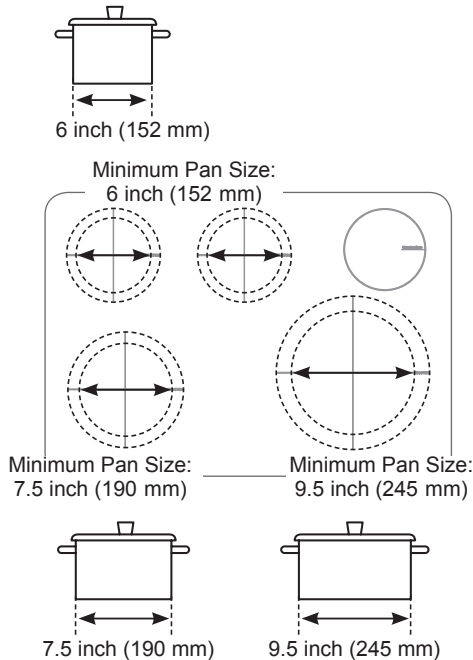

Use the cross that marks each cooking element to help determine the maximum pan size. After centering the cookware on the cooking element, the cookware should not extend more than $\frac{1}{2}$ " beyond the edge of the cross on the cooking element. The pan must make full contact with the glass surface without the bottom of the pan touching the metal cooktop trim.

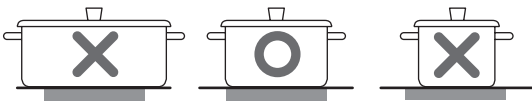

If the correct induction cookware—centered on any of the active cooking elements—is too small, the affected cooking element's LED bar fluctuates and the pan does not heat.

Hot Cookware and Residual Heat

CAUTION

Unlike radiant surface elements, induction cooking elements do not glow red when hot. You can be burned if the glass surface is hot from the residual heat transferred from the cookware. Do not touch hot cookware or pans. Use oven mitts or potholders to protect hands from burns.

Home Canning

CAUTION

Canning can generate large amounts of steam. Use extreme caution to prevent burns. Raise the lid so that steam is vented away from you. Safe canning requires that harmful micro-organisms are destroyed and jars are sealed completely. When using a water bath canner, maintain a gentle but steady boil for the required time.

Read and observe the following precautions when home canning. Read the information on the USDA (United States Department of Agriculture) website and follow the recommendations there for home canning procedures.

- Use only quality, flat-bottomed canners when home canning. Use a ruler to check the bottom of the canner for flatness.
- Canners with ridges that radiate from the bottom center are not suitable for use on a ceramic glass cooktop.
- The diameter of the canner should not exceed the maximum cooking element markings by more than one inch. Use smaller diameter canners on ranges with ceramic-glass or open-coil-electric cooktops.
- Start with hot tap water to boil water more quickly. Bring water to an initial boil using the highest heat setting. Once the water is boiling, reduce the heat as much as possible while maintaining the boil.
- It is best to can small amounts and keep the canner light enough to lift.
- Do not leave the water bath or pressure canners on high heat for extended periods.
- Alternate surface elements between each batch to allow the elements and surrounding surfaces to cool down. Do not can using the same element all day.

Setting Surface Controls

• Cooking Element LED Bar

The range provides an LED bar for each cooking element on the cooktop. Check messages in the display window and use the LEDs with the corresponding control knobs to monitor the power levels of the elements.

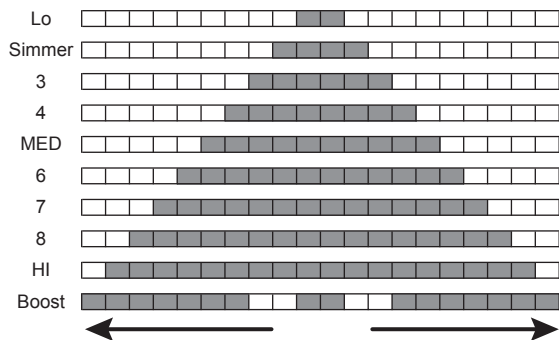

• Available Power Level Settings

The cooktop control's LED bar displays the element's power level settings, ranging from Lo to Hi to Boost. Adjust the settings in increments of one, from Lo (Level 1) to Boost (Level 10). To select Hi, turn the knob clockwise, through level 8 to Hi/Boost.

• Boost Power Level

To activate the Boost mode, turn the knob directly from Off to Boost. Boost mode is only available immediately after activating a cooking element. When the cooking element is set to the Boost mode, the LED bar flashes and the Boost mode stays in operation for up to 10 minutes. After 10 minutes, the cooking element automatically returns to the Hi setting.

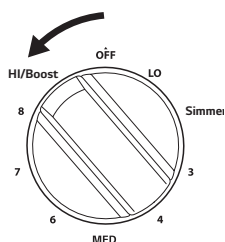

The maximum operating time for all element levels except the Boost mode is 12 hours.

Hot Surface Indicator

The hot surface indicator light glows as long as any surface cooking area is too hot to touch.

It remains on after the element is turned off and until the surface has cooled to approximately 130 °F.

It is normal for the surface elements to cycle on and off when cooking at lower temperature settings.

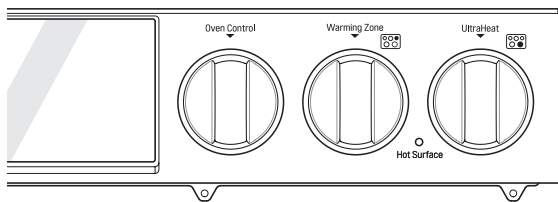

Using the Cooking Elements

! CAUTION

Before Cooking

- Do not place or store flammable or heat-sensitive items on the induction cooktop, even when the cooktop is not in use.
- Place cookware on the cooking elements before turning on the induction cooktop.
- Do not place sealed containers on the cooktop.

During Cooking

- Do not place metallic objects such as knives, forks, spoons, and lids on the induction cooktop surface; they can get hot.
- Use this appliance only for normal household use. It is not designed for commercial or industrial use.
- Never use the appliance to heat the room.
- Use caution when plugging electrical appliances into power outlets near the cooktop. Keep power cords from any contact with the cooktop or cookware.
- Overheated fat and oil can catch fire quickly. Never leave surface elements unattended when frying foods.
- Do not use the induction cooktop to heat aluminum foil, products wrapped in aluminum foil, or frozen foods packaged in aluminum cookware.
- Use caution when plugging electrical appliances into outlets near the cooktop to keep power cords away from the hot cooktop or cookware.
- Users with pacemakers and active heart implants must keep their upper body at a minimum distance of 1 ft (30 cm) from active induction cooking elements. If in doubt, consult the implant manufacturer or your doctor.

After Cooking

- After use, switch off the induction cooking element using its control. Do not rely on the pan sensor.

Turning On Cooking Elements (Except Warming Zone)

- 1 Push the control knob in.
- 2 Turn the knob in either direction to select the desired setting. A short beep sounds and the cooking element's LED bar shows its current setting.
- 3 To activate the Boost mode, turn the knob directly from Off to Boost.

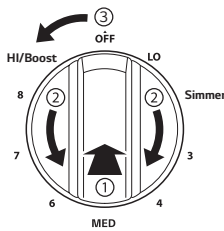

The Recommended Surface Cooking Setting

Start most surface cooking on a higher setting and then adjust to a lower setting to finish cooking.

The suggested settings may need adjustments, depending on cookware design and quality and on the amount of food being prepared.

Use quality cookware that is constructed with a magnetic base material and that meets the minimum and maximum pan size requirements.

Setting	Recommended Use
Boost	<ul style="list-style-type: none"> • Use to heat a large amount of food or to bring large pans of water to a boil
8-Hi	<ul style="list-style-type: none"> • Bring liquid to a boil • Start most cooking
MED-8	<ul style="list-style-type: none"> • Hold a rapid boil, fry, deep fat fry • Quickly brown or sear food • Steaks, cutlets, grilled meat
3-MED	<ul style="list-style-type: none"> • Maintain a slow boil • Fry or sauté foods • Cook soups, sauces and gravies • Eggs, pancakes
SIMMER-3	<ul style="list-style-type: none"> • Stew or steam food • Simmer
Lo-SIMMER	<ul style="list-style-type: none"> • Keep food warm • Melt chocolate or butter • Simmer

Pan Preheat Recommendations

Induction cooking may decrease the amount of time required to preheat cookware compared to cooking on a radiant element cooktop or gas surface burner.

Pay close attention to all food items while cooking on the cooktop or in the oven, and until all cooking processes are complete.



CAUTION

Remember that induction surface cooking initially heats the cookware **VERY QUICKLY** if the cookware does not contain food.

Noises during Cooktop Operation

The electronic processes involved with induction cooking may create some background noises. You may hear a slight buzzing sound when cooking on the cooktop. These noises are part of the induction cooking process and are considered normal.

Some cookware will buzz, depending on the construction or base material. The buzz may be more noticeable if the contents of the pan are cold. As the pan heats up, the noise will decrease. The noise will also decrease if the power level setting is reduced.

NOTE

- When using the induction cooktop, operational noises are more noticeable while cooking in Boost mode. But very loud noises are not normal when induction cooking.
- The cooktop fan may turn on to reduce the temperature of the product, even when the surface elements are not being used.

Power Management

The cooking zones, which consist of paired cooking elements, are restricted to drawing a certain maximum amount of power.

If you turn on the Boost function for one element while its paired element is in use, the Power Management function may automatically reduce the power of both elements. For consistent performance when using multiple elements, use elements in separate cooking zones.

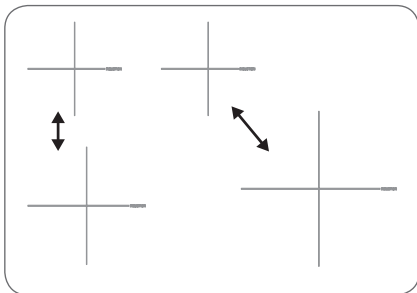

NOTE

- If the combined heat of the oven and the surface burners is sufficiently high, the output of the surface burners is reduced to avoid damage to the product.
- Both elements in a set of paired elements cannot use the Boost mode at the same time. To use the Boost mode on two elements simultaneously, use non-paired elements.

Warming Zone

Use the Warming Zone, located in the back right of the glass surface, to keep hot, cooked food at serving temperature. The Warming Zone keeps food warm after it has already been cooked. Attempting to cook uncooked or cold food on the Warming Zone could result in a food-borne illness.



CAUTION

FOOD POISON HAZARD: Bacteria may grow in food at temperatures below 140 °F.

- Always start with hot food. Do not use the warm setting to heat cold food.
- Do not use the warm setting for more than two hours.

Turning On Warming Zone

- 1 Push the control knob in.
- 2 Turn the knob in either direction to select the desired setting.

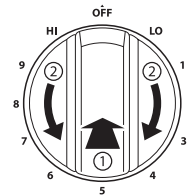

For best results :

- When warming pastries or breads, leave an opening in the cover to allow moisture to escape.
- Do not use plastic wrap to cover food. Plastic may melt onto the surface and be very difficult to remove.
- Use only dishware, utensils and cookware that is recommended for oven and cooktop use.

NOTE

- For best results, food on the Warming Zone should be kept in its container or covered with a lid or aluminum foil to maintain food quality.
- Do not allow aluminum foil to contact the hot induction cooktop surface.

If a particular food is not listed, start with the medium heat level and adjust as needed. Most foods can be kept at serving temperatures by using the medium heat level.

Setting	Food Item
Low (Lo-3)	<ul style="list-style-type: none"> • Vegetables • Rice • Pasta • Sugary sauces (tomato sauce, BBQ sauce)
Medium (3-7)	<ul style="list-style-type: none"> • Cream-based soups and sauces • Stews and chili • Warming empty plates or serving dishes
High (7-Hi)	<ul style="list-style-type: none"> • Broth-based soups • Hot beverages (hot cider, hot chocolate)

Using the Oven

Before Using the Oven

NOTE

- Because the oven temperature cycles, an oven thermometer placed in the oven cavity may not show the same temperature that is set on the oven.
- It is normal for the convection fan to run while preheating during a regular bake cycle.
- The convection fan motor may run periodically during a regular bake cycle.
- The heat turns off if the door is left open during baking. If the door is left open for longer than 30 seconds during baking, the heat turns off. The heat turns back on automatically once the door is closed.

Oven Vent

Areas near the vent may become hot during operation and may cause burns. Do not block the vent opening. Avoid placing plastics near the vent as heat may distort or melt the plastic.

It is normal for steam to be visible when cooking foods with high moisture content.

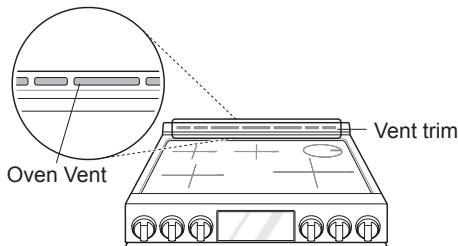

CAUTION

- **The edges of the range vent and vent trim are sharp and may become hot during operation.** Wear gloves when cleaning the range to avoid burns or other injury.

Using Oven Racks

The racks have a turned-up back edge that prevents them from being pulled out of the oven cavity.

Removing Racks

- 1 Pull the rack straight out until it stops.
- 2 Lift up the front of the rack and pull it out.

Replacing Racks

- 1 Place the end of the rack on the support.
- 2 Tilt the front end up and push the rack in.

CAUTION

- Replace oven racks before turning the oven on to prevent burns.
- Do not cover the racks with aluminum foil, or any other material, or place anything on the bottom of the oven. Doing so will result in poor baking and may damage the oven bottom.
- Only arrange oven racks when the oven is cool.

Bake

Bake is used to prepare foods such as pastries, breads and casseroles. The oven can be programmed to bake at any temperature from 170 °F (80 °C) to 550 °F (285 °C). The default temperature is 350 °F (175 °C).

Setting the Bake Function (example, 375 °F)

- 1 Turn the oven mode knob to select **Bake**.
- 2 Set the oven temperature: for example, press **plus(+)** until 375 °F appears in the display.
- 3 Press **Start**. The oven starts to preheat.

As the oven preheats, the temperature is displayed and rises in 5 degree increments. Once the oven reaches the set temperature, a tone sounds and the oven light blinks on and off.

- 4 When cooking is complete, turn the oven mode knob to the **Off** position.
- 5 Remove food from the oven.

NOTE

It is normal for the convection fan to operate periodically throughout a normal bake cycle in the oven. This is to ensure even baking results.

Baking Tips

- Baking time and temperature will vary depending on the characteristics, size, and shape of the baking pan used.
- Check for food doneness at the minimum recipe time.
- Use metal bakeware (with or without a nonstick finish), heatproof glass-ceramic, ceramic or other bakeware recommended for oven use.
- Dark metal pans or nonstick coatings will cook food faster with more browning. Insulated bakeware will slightly lengthen the cooking time for most foods.

NOTE

The oven bottom has a porcelain-enamel finish. To make cleaning easier, protect the oven bottom from excessive spillovers by placing a cookie sheet on the rack below the rack you are cooking on. This is particularly important when baking a fruit pie or other foods with a high acid content. Hot fruit fillings or other foods that are highly acidic may cause pitting and damage to the porcelain-enamel surface and should be wiped up immediately.

Convection Mode

The convection system uses a fan to circulate the heat evenly within the oven. Improved heat distribution allows for even cooking and excellent results while cooking with single or multiple racks.

Setting the Convection Function (example, 375 °F)

- 1 Turn the oven mode knob to select the **Conv. Bake** or **Conv. Roast**.
- 2 Set the oven temperature: for example, press **plus(+)** until 375 °F appears in the display.
- 3 Press **Start**. The display shows **Conv. Bake** or **Conv. Roast** and the oven temperature starting at 100 °F.

As the oven preheats, the display shows increasing temperatures in 5-degree increments. Once the oven reaches the set adjusted temperature, a tone sounds and the oven light flashes on and off. The display shows the auto converted oven temperature, 350 °F and the fan icon.

- 4 When cooking has finished or to cancel, turn the oven mode knob to the **Off** position.

NOTE

The oven fan runs while convection baking. The fan stops when the door is open. In some cases, the fan may shut off during a convection bake cycle.

Tips for Convection Baking

- Use Convection Bake for faster and more even multiple-rack cooking of pastries, cookies, muffins, biscuits, and breads of all kinds.
- Bake cookies and biscuits on pans with no sides or very low sides to allow heated air to circulate around the food. Food baked on pans with a dark finish will cook faster.
- If cooking on single rack, place the rack in the position suggested in the charts on the following pages. If cooking on multiple racks, place the oven racks in positions 3 and 5 (for two racks).
- Multiple oven rack cooking may slightly increase cook times for some foods.
- Cakes, cookies and muffins have better results when using multiple racks.

The Convection Roast feature is designed to give optimum roasting performance. Convection Roast combines cooking with the convection fan to roast meats and poultry. The heated air circulates around the food from all sides, sealing in juices and flavors. Foods are crispy brown on the outside while staying moist on the inside. Convection roasting is especially good for large tender cuts of meat, uncovered.

Tips for Convection Roasting

Use a broiler pan and grid when preparing meats for roasting. The broiler pan catches grease spills and the grid helps prevent grease splatters.

- 1 Place the oven rack in the position suggested in the charts on the following pages.
- 2 Place the grid in the broiler pan.
- 3 Place the broiler pan on the oven rack.

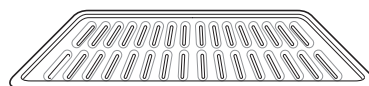

Grid (sold separately)

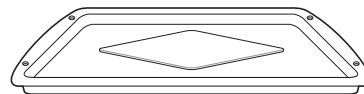

Broiler pan (sold separately)



CAUTION

- Do not use a broiler pan without a grid.
- Do not cover the grid with aluminum foil.
- Position food (fat side up) on the grid.

Recommended Baking and Roasting Guide

Baking results will be better if baking pans are centered in the oven as much as possible. If cooking on multiple racks, place the oven racks in the positions shown.

Rack and Pan Placement

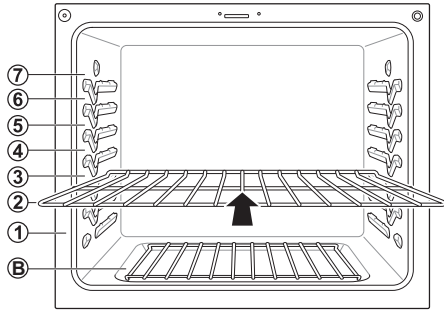

Single rack baking

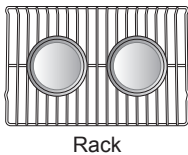

Multiple rack baking

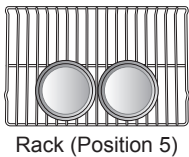

Multiple rack roasting

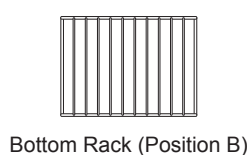
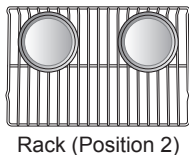
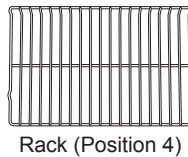

- Multiple roasting helps to make more than 2 roasted foods at same time.
- If roasting on multiple racks, place more than 2 broiler pans and 2 grids on the racks.

NOTE

For best results, use the Bake mode for cakes and the Convection Bake mode for cookies.

Baking rack guide

Food		Rack position
Cakes	• Layer cakes	5
	• Bundt cakes	3
	• Angel food cake	3
Cookies	• Sugar cookies	4
	• Chocolate chips	4
	• Brownies	4
Pizza	• Fresh	5
	• Frozen	5
Pastry Crust	• From scratch	4
	• Refrigerator	4
Breads	• Biscuit, canned	5
	• Biscuit, from scratch	5
	• Muffins	5
Desserts	• Fruit crisps and cobblers, from scratch	4
	• Pies, from scratch, 2-crust fruit	4
Custards	• Cheesecake, crème brûlée	2
Soufflés	• Sweet or savory	2
Casserole	• Frozen lasagna	5

Roasting rack guide

Food		Rack position	
Beef	Rib	Rare	2
		Medium	2
		Well done	2
	Boneless rib, top sirloin	Rare	2
		Medium	2
		Well done	2
	Beef tenderloin	Rare	2
		Medium	2
	Pork	Rib	2
Bone-in, sirloin		2	
Ham, cooked		2	
Poultry	Whole chicken	2	
	Chicken pieces	2	
	Turkey	2 or B	

Broil

The Broil function uses intense heat from the upper heating element to cook food. Broiling works best for tender cuts of meat, fish, and thinly cut vegetables.

Some models may feature a hybrid broiler consisting of an inner broiler that utilizes a carbon heating element which provides instantaneous heat, and a traditional outer broiling element. During normal broiler operation, it is normal for either element to cycle off intermittently.



CAUTION

- Do not use a broiler pan without a grid. Oil can cause a grease fire.
- Do not cover the grid and broiler pan with aluminum foil. Doing so will cause a fire.
- Always use a broiler pan and grid for excess fat and grease drainage. This will help to reduce splatter, smoke, and flare-ups.

NOTE

- This range is designed for closed-door broiling. Close the door to set the Broil function. If the door is open, the Broil function cannot be set and **door** appears on the display. Close the door and reset the Broil function. Opening the door turns off the broil burner during broiling. If the door is opened during broiling, the broil burner turns off after five seconds. The broiler turns back on automatically once the door is closed.

Setting the oven to Broil

- 1 Turn the oven mode knob to select **Broil Hi, Lo**.
- 2 Press **plus(+)** or **minus(-)** to select **Hi** or **Lo**.
- 3 Press **Start**. The oven begins to heat.
- 4 Let the oven preheat for approximately five minutes before cooking the food if using broil.
- 5 Turn the oven mode knob to the **Off** position to cancel at any time or when cooking is complete.

Smoking

Due to the intense heat associated with broiling, it is normal to experience smoke during the cooking process. This smoke is a natural byproduct of searing and should not cause you to worry. If you are experiencing more smoke than you are comfortable with, use the following tips to reduce the amount of smoke in your oven.

- 1 Always use a broiler pan. Do not use saute pans or regular baking sheets for safety reasons.
- 2 The broiler pan should always be thoroughly cleaned and at room temperature at the beginning of cooking.
- 3 Always run your cooktop ventilation system or vent hood during broiling.
- 4 Keep the interior of your oven as clean as possible. Leftover debris from prior meals can burn or catch fire.
- 5 Avoid fatty marinades and sugary glazes. Both of these will increase the amount of smoke you experience. If you would like to use a glaze, apply it at the very end of cooking.
- 6 If you are experiencing significant smoke with any food item, consider:
 - Lowering the broiler to the Lo setting.
 - Lowering the rack position to cook the food further away from the broiler.
 - Using the Hi broil setting to achieve the level of searing you desire, and then either switching to the Lo broil setting, or switching to the Bake function.
- 7 As a rule, fattier cuts of meat and fish will produce more smoke than leaner items.
- 8 Adhere to the recommended broil settings and cooking guidelines in the chart on the following page whenever possible.

Recommended Broiling Guide

The size, weight, thickness, starting temperature, and your preference of doneness will affect broiling times.

This guide is based on meats at refrigerator temperature. For best results when broiling, use a pan designed for broiling.

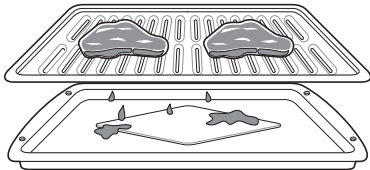

Food	Quantity and/or Thickness	Rack Position	First Side (minutes)	Second Side (minutes)	Comments
Ground Beef Well done	1 lb. (4 patties) 1/2 to 3/4" thick	7	3-6	2-4	Space evenly. For 1-4 patties, use Speed Broil. For more than 4 patties, use Broil.
Beef Steaks Rare Medium Well done	1" thick 1 to 1 1/2 lbs.	7 7 7	3-5 4-6 5-7	2-4 2-4 3-5	Steaks less than 1" thick cook through before browning. Pan frying is recommended. Slash fat.
Rare Medium Well done	1 1/2" thick 2 to 2 1/2 lbs.	5 5 5	7-9 9-11 11-13	4-6 6-8 8-10	
Toast		7	0.5-1	0.5	
Chicken	1 whole cut up 2 to 2 1/2 lbs., split lengthwise 2 Breasts	5 5	8-10 8-10	4-6 5-7	Broil skin-side-down first.
Lobster Tails	2-4 10 to 12 oz. each	5	9-12	Do not turn over	Cut through back of shell. Spread open. Brush with melted butter before broiling and after half of broiling time.
Fish Fillets	1/4 to 1/2" thick	6	2-4	2-4	Handle and turn very carefully. Brush with lemon butter before and during cooking, if desired.
Ham Slices (precooked)	1/2" thick	5	2-4	2-4	Increase time 5 to 10 minutes per side for 1 1/2" thick or home-cured ham.
Pork Chops Well done	1 (1/2" thick) 2 (1" thick) about 1 lb.	6 5	3-6 5-8	4-7 5-8	
Lamb Chops Medium Well done	2 (1" thick) about 10 to 12 oz.	6 6	3-5 5-7	2-5 4-7	
Medium Well done	2 (1 1/2" thick) about 1 lb.	6 6	7-9 9-11	7-9 7-9	
Salmon Steaks	2 (1" thick) 4 (1" thick) about 1 lb.	5 5	8-10 9-11	3-5 4-6	Grease pan. Brush steaks with melted butter.

- This guide is only for reference. Adjust cook time according to your preference.
- For best performance, center food on rack when using Speed Broil/Broil.

Tips for Broiling

Beef

- Steaks and chops should always be allowed to rest for five minutes before being cut into and eaten. This allows the heat to distribute evenly through the food and creates a more tender and juicy result.
- Pieces of meat that are thicker than two inches should be removed from the refrigerator 30 minutes prior to cooking. This will help them cook more quickly and evenly, and will produce less smoke when broiling. Cooking times will likely be shorter than the times indicated in the Broiling Chart.
- For bone-in steaks or chops that have been *frenched* (all meat removed from around the bone), wrap the exposed sections of bone in foil to reduce burning.

Seafood

- When broiling skin-on fish, always use the Lo broil setting and always broil the skin side last.
- Seafood is best consumed immediately after cooking. Allowing seafood to rest after cooking can cause the food to dry out.
- It is a good idea to rub a thin coating of oil on the surface of the broiling pan before cooking to reduce sticking, especially with fish and seafood. You can also use a light coating of non-stick pan spray.

Vegetables

- Toss your vegetables lightly in oil before cooking to improve browning.

Warm

This function will maintain an oven temperature of 170 °F. The Warm function will keep cooked food warm for serving up to three hours after cooking has finished. The Warm function may be used without any other cooking operations.

Setting the Warm Function

- 1 Turn the oven mode knob to select **Warm**.
- 2 Press **Start**.
- 3 Turn the oven mode knob to the **Off** position when warming is finished.

NOTE

- The Warm function is intended to keep food warm. Do not use it to cool food down.
- It is normal for the fan to operate during the Warm function.

Proof

This feature maintains a warm oven for rising yeast leavened products before baking.

Setting the Proof Function

- 1 Use rack position 2 or 3 for proofing.
- 2 Turn the oven mode knob to select **Proof**.
- 3 Press **Start**.
- 4 Turn the oven mode knob to the **Off** position when proofing is finished.

NOTE

- To avoid lowering the oven temperature and lengthening proofing time, do not open the oven door unnecessarily. Check bread products early to avoid over proofing.
- Do not use the proofing mode for warming food or keeping food hot. The proofing oven temperature is not hot enough to keep foods at safe temperatures. Use the Warm feature to keep food warm. Proofing does not operate when the oven is above 125 °F. **Hot** shows in the display.
- It is normal for the fan to operate during the Proof function.

Speed Roast

The Speed Roast feature is designed to quickly roast poultry. The combination of intense heat from the upper heating element and heated air from the back heating element result in crispier food and help to save cooking time. Speed roasting is especially good for medium sized poultry.

NOTE

- The recommended cook time is 60-65 minutes for a whole chicken weighing 3.3 lb.
- Adjust the cook time according to the weight of the poultry.
- Place the oven rack in position 2.
- Speed Roast is designed to reduce the cooking time. There is no need for preheating.
- This function is optimized for poultry, so the temperature of Speed Roast cannot be changed.
- It is normal for the fan to operate during the Speed Roast function.

Setting the Speed Roast Function

- 1 Put food in the oven.
- 2 Turn the oven mode knob to select **Speed Roast**. The display shows **Roast Speed**.
- 3 Press **Start**.

Meat Probe

The meat probe accurately measures the internal temperature of meat, poultry and casseroles. It should not be used during broiling, self clean, warming or proofing. Always unplug and remove the meat probe from the oven when removing food. Before using, insert the probe into the center of the thickest part of the meat or into the inner thigh or breast of poultry, away from fat or bones. Place food in the oven and connect the meat probe to the jack. Keep the probe as far away from heat sources as possible.

Setting the Meat Probe Function (example for Roast 375 °F with Probe temp. 160 °F)

- 1 Insert the meat probe into the meat.

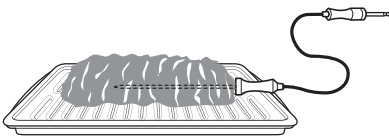

- 2 Connect the meat probe to the jack.

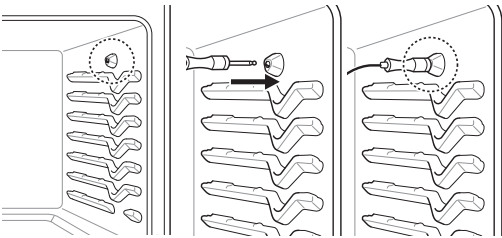

- 3 The meat probe icon flashes in the display if the meat probe is properly connected.

Setting the Probe Temperature

- 1 Select cook mode. Turn the oven mode knob to select **Conv. Roast**.
- 2 Set the oven temperature: press **plus(+)** or **minus(-)** until 375 °F appears in the display.
- 3 Press **Probe**.
- 4 Set the probe temperature: press **plus(+)** or **minus(-)** until 160 °F appears in the display.
- 5 Press **Start**.

The default probe temperature is 150 °F (65 °C), but can be changed to any temperature between 80 °F (27 °C) and 210 °F (100 °C). The display shows the changing probe temperature. When the set probe temperature is reached, the oven shuts off automatically.

Changing the Probe temperature while cooking

- 1 Press **Probe**.
- 2 Set the probe temperature.
- 3 Press **Start**.

IMPORTANT NOTE

Turn the oven mode knob to the **Off** position to cancel the Meat Probe function at any time. To avoid breaking the probe, make sure food is completely defrosted before inserting.

CAUTION

- Always use an oven mitt to remove the temperature probe. Do not touch the broil element. Failure to obey this caution can result in severe personal injury.
- To avoid damage to the meat probe, do not use tongs to pull on the probe when removing it.
- Do not store the meat probe in the oven.
- Do not pull wire to remove probe. Hold the probe head, not the wire, when inserting or removing probe.

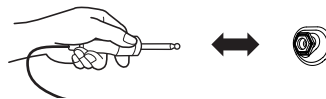

Recommended Probe Temperature Chart

Doneness	Probe Temp.
Beef, Lamb and Veal	
Rare	130 °F (54 °C)
Medium Rare	140 °F (60 °C)
Medium	150 °F (66 °C)
Well Done	160 °F (71 °C)
Pork	
Well Done	170 °F (77 °C)
Poultry	
Breast, Well Done	170 °F (77 °C)
Thigh, Well Done	180 °F (82 °C)
Stuffing, Well Done	165 °F (74 °C)

Remote Start

If the appliance is registered on a home Wi-Fi network, this function starts or stops the pre-heating function of the appliance. Follow the instructions on page 43 to register the appliance on the network.

Set the oven mode knob to the Remote Start position to use the function.

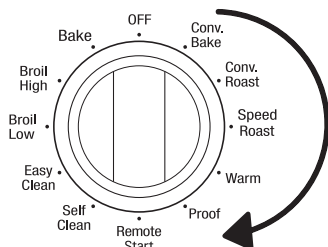

Setting Remote Start

- 1 Open the oven door to make sure the oven is empty and ready for pre-heating. Do not place food in the oven. Close the oven door.
- 2 Turn the oven mode knob to select Remote Start.
- 3 When ON appears in the display, the Remote Start function is ready to use.
- 4 Follow the directions in the smart phone application to set the cook mode, temperature, and run time (preheating time plus holding time).

NOTE

Do not place food in oven before or during Remote Start run time. Remote Start is disconnected in the following situations:

- Remote Start is never set up in the smart phone app.
- The Remote Start status is "OFF" or "door".
- Remote Start experiences a problem during operation.
- The Remote Start function cannot be started when the oven door is open. A beep alerts you to shut the door.

Sabbath Mode

Sabbath mode is used on the Jewish Sabbath and Holidays. While the oven is in Sabbath mode, the timer, light, and alarm functions are disabled. If the oven light is on when the oven is put in Sabbath mode, it will remain on. Sabbath mode is only available when oven is in Bake mode.

Setting Sabbath Mode

- 1 Disconnect the probe. The probe function is not available in Sabbath mode.
- 2 Turn the oven mode knob to select **Bake**.
- 3 Set the desired temperature and cook time.
- 4 Press **Start**.
- 5 Touch and hold **Start Time** for three seconds. **SB** appears in the display when the Sabbath mode is activated.
- 6 To stop Sabbath mode, touch and hold **Start Time** for three seconds. To cancel the Bake function, set the oven mode knob to the **Off** position at any time.

Adjusting the Oven Temperature

- 1 Press **plus (+)** or **minus (-)** once to enter the setting mode.
- 2 To change the set temperature, press **plus (+)** or **minus (-)**. Each press increases or decreases the set temperature by 5 degrees.
- 3 Press **Start** to accept the change.

NOTE

- If a cook time is set, the oven turns off automatically at the end of the cook time, without chiming. The oven remains in Sabbath mode, but is turned off.
- If no cook time is set, the oven will not automatically turn off.
- After a power failure, the display will turn back on in Sabbath mode, but the oven will be off.
- Please always close the oven door first before engaging Sabbath Mode.
- The oven does not beep and the display does not change while in Sabbath mode.
- After 15 seconds, the oven adjusts its set temperature.
- The cooktop cannot be used in Sabbath Mode.

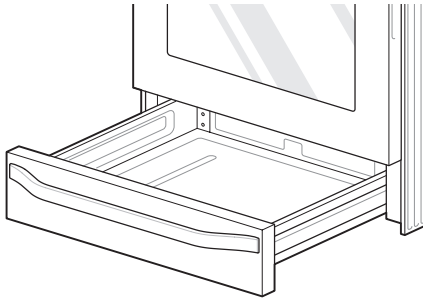

Operating the Warming Drawer



The Warming Drawer keeps hot cooked foods at serving temperature.

All food placed in the Warming Drawer should be covered with an oven-safe lid or aluminum foil to maintain quality. Do not place foil on bottom or sides of drawer. Do not use plastic wrap to cover food. Plastic may melt onto the drawer and be very difficult to clean. Use only utensils and cookware recommended for oven use in the Warming Drawer.



Setting the Warming Drawer Control

- 1 Press **Warming Drawer Set/Off**. The indicator light will flash. (If no further buttons are pressed within 25 seconds, the display will clear.)
- 2 Use the **plus(+)** or **minus(-)** button to set the power level:  for Low,  for Medium, and  for High.
- 3 When the food is ready, or to cancel, press **Warming Drawer Set/Off**.

NOTE

- The Warming Drawer shuts off automatically after three hours.
- Do not heat cold food in the Warming Drawer.
- Do not use pans or utensils with rough finishes in the Warming Drawer. Doing so can leave scratches on the inner drawer surfaces.

Warming Drawer food/power level recommendations

Setting	Food Item
Low 140 °F (60 °C) 	<ul style="list-style-type: none"> • Vegetables • Rice • Pasta • Breakfast pastries (coffee cake, muffins) • Dinner rolls • Plates of food • Heat-sensitive foods* (pancakes, pizza, eggs)
Medium 160 °F (71 °C) 	<ul style="list-style-type: none"> • Meat* (if warming for 1-2 hours) • Smaller casseroles • Bacon or sausage • Warming empty ovenproof plates or serving dishes
High 180 °F (82 °C) 	<ul style="list-style-type: none"> • Meat* (if warming for less than an hour) • Large casseroles

* Do not warm heat-sensitive foods for longer than 20 minutes.

Do not put thin cuts of meat in the warming drawer as they will dry out.

Different types of food may be placed in the warming drawer at the same time. For best results, do not leave food in the warming drawer for more than one hour. Do not leave smaller quantities or heat-sensitive food, such as eggs, in the warming drawer more than 30 minutes. The maximum operating time is three hours.

**CAUTION**

- Do not use the warming drawer for storage of racks, broiler pans, insert pans, plates, or utensils. The warming drawer contains a heating element which may damage any items not specifically designed to be used with it and should only be used to store cookware specifically supplied by LG with your range.
- Do not put food or foil directly on the surface or base of the warming drawer. This may result in damage to your drawer and may spoil your food.
- Do not place plastic wrap in the warming drawer or use it to cover food being heated in the warming drawer. Plastic may melt onto the drawer or surrounding areas and is very difficult to remove. Use only aluminum foil or cookware that is capable of withstanding baking temperature to heat or cover your food.
- Do not use the warming drawer to heat water or any other liquids. Spilled liquids may cause an electrical short or result in severe personal injury, electric shock or death.
- Never place plastics, paper, canned foods or other combustible material into the warming drawer. These items pose a severe risk of fire, damage and injury.
- In the unlikely event that an item falls behind the warming drawer, always turn the power off and wait for the warming drawer to cool before retrieving the item. Never attempt to retrieve any items that fall behind the warming drawer without first turning the power off and ensuring the warming drawer cavity has cooled off. Failure to do so may result in severe personal injury, electric shock or death.
- Do not touch the surface of the warming drawer while it is in operation. Use oven mitts or hot pads when inserting or removing food to avoid burns or other injury.
- Do not leave food in the warming drawer for longer than one hour. Eating food which has been heated for too long at low temperatures can lead to food-borne illnesses.



GlideShut™ Drawer

The drawer uses a spring and damper mechanism to absorb the impact when closing. Performance may vary based on the load in the drawer and how frequently it is used. A gentle tug may be necessary to overcome the damper mechanism at first when opening the drawer.

- The weight of a lot of food in the drawer may work with the damper mechanism to prevent the drawer from closing completely. If this happens, push the drawer gently until the closing mechanism engages and pulls the drawer completely closed.

SMART FUNCTIONS

LG ThinQ Application

This feature is only available on models with the  or  logo.

The **LG ThinQ** application allows you to communicate with the appliance using a smartphone.

LG ThinQ Application Features

Smart Diagnosis™

This function provides useful information for diagnosing and solving issues with the appliance based on the pattern of use.

Settings

Allows you to set various options on the oven and in the application.

Monitoring

This function shows the current status, remaining cook time, and cook settings on one screen.

Push Alerts

Turn on the Push Alerts to receive appliance status notifications.

The notifications are triggered even if the LG ThinQ application is off.

Timer

You can set the timer from the application.

Firmware Update

Keep the appliance updated.

NOTE

- If you change your wireless router, Internet service provider, or password, delete the connected appliance from the **LG ThinQ** application and connect it again.
- This information is current at the time of publication. The application is subject to change for product improvement purposes without notice to users.
- This feature is only available on some models.

Before Using LG ThinQ Application

- 1 Use a smartphone to check the strength of the wireless router (Wi-Fi network) near the appliance.
 - If the appliance is too far from the router, the signal becomes weak. It may take a long time to connect or fail to install the application.
- 2 Turn off the **Mobile data** or **Cellular Data** on your smartphone.

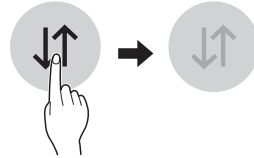

- 3 Connect your smartphone to the wireless router.

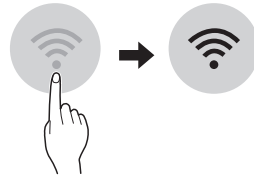

NOTE

- To verify the Wi-Fi connection, check that the **Wi-Fi**  icon on the control panel is lit.
- The appliance supports 2.4 GHz Wi-Fi networks only. To check your network frequency, contact your Internet service provider or refer to your wireless router manual.
- **LG ThinQ** is not responsible for any network connection problems or any faults, malfunctions, or errors caused by network connection.
- The surrounding wireless environment can make the wireless network service run slowly.
- If the appliance is having trouble connecting to the Wi-Fi network, it may be too far from the router. Purchase a Wi-Fi repeater (range extender) to improve the Wi-Fi signal strength.
- The network connection may not work properly depending on the Internet service provider.
- The Wi-Fi connection may not connect or may be interrupted because of the home network environment.
- If the appliance cannot be connected due to problems with the wireless signal transmission, unplug the appliance and wait about a minute before trying again.

NOTE

- If the firewall on your wireless router is enabled, disable the firewall or add an exception to it.
- The wireless network name (SSID) should be a combination of English letters and numbers. (Do not use special characters.)
- Smartphone user interface (UI) may vary depending on the mobile operating system (OS) and the manufacturer.
- If the security protocol of the router is set to **WEP**, network setup may fail. Change the security protocol (**WPA2** is recommended), and register the product again.

Installing the LG ThinQ Application

Search for the **LG ThinQ** application from the Google Play Store or Apple App Store on a smartphone. Follow instructions to download and install the application.

Open Source Software Notice Information

To obtain the source code under GPL, LGPL, MPL, and other open source licenses, that is contained in this product, please visit <http://opensource.lge.com>. In addition to the source code, all referred license terms, warranty disclaimers and copyright notices are available for download.

LG Electronics will also provide open source code to you on CD-ROM for a charge covering the cost of performing such distribution (such as the cost of media, shipping, and handling) upon email request to opensource@lge.com. This offer is valid for a period of three years after our last shipment of this product. This offer is valid to anyone in receipt of this information.

Wireless LAN Module (LCW-004) Specifications

Frequency Range	2412~2462 MHz
Output Power (max.)	< 30 dBm

FCC Notice

The following notice covers the transmitter module contained in this product. This equipment has been tested and found to comply with the limits for a Class B digital device, pursuant to Part 15 of the FCC Rules and also Part 18 of the FCC Rules. These limits are designed to provide reasonable protection against harmful interference in a residential installation. This equipment generates, uses, and can radiate radio frequency energy and, if not installed and used in accordance with the instructions, may cause harmful interference to radio communications. However, there is no guarantee that interference will not occur in a particular installation. If this equipment does cause harmful interference to radio or television reception, which can be determined by turning the equipment off and on, the user is encouraged to try to correct the interference by one or more of the following measures:

- Reorient or relocate the receiving antenna.
- Increase the separation between the equipment and the receiver.
- Connect the equipment into an outlet on a circuit different from that to which the receiver is connected.
- Consult the dealer or an experienced radio/TV technician for help.

This device complies with Part 15, Part 18 of the FCC Rules. Operation is subject to the following two conditions:



- 1) This device may not cause harmful interference and
- 2) This device must accept any interference received, including interference that may cause undesired operation.

Any changes or modifications in construction of this device which are not expressly approved by the party responsible for compliance could void the user's authority to operate the equipment.

FCC RF Radiation Exposure Statement

This equipment complies with FCC radiation exposure limits set forth for an uncontrolled environment. This transmitter must not be co-located or operating in conjunction with any other antenna or transmitter. This equipment should be installed and operated with minimum distance 20 cm (7.8 inches) between the antenna and your body. Users must follow the specific operating instructions for satisfying RF exposure compliance.

Smart Diagnosis™ Feature

This feature is only available on models with the  or  icon.

Use this feature to help you diagnose and solve problems with your appliance.

NOTE

- For reasons not attributable to LGE's negligence, the service may not operate due to external factors such as, but not limited to, Wi-Fi unavailability, Wi-Fi disconnection, local app store policy, or app unavailability.
- The feature may be subject to change without prior notice and may have a different form depending on where you are located.

Using LG ThinQ to Diagnose Issues

If you experience a problem with your Wi-Fi equipped appliance, it can transmit troubleshooting data to a smartphone using the **LG ThinQ** application.

- Launch the **LG ThinQ** application and select the **Smart Diagnosis** feature in the menu. Follow the instructions provided in the **LG ThinQ** application.

Using Audible Diagnosis to Diagnose Issues

Follow the instructions below to use the audible diagnosis method.

- Launch the **LG ThinQ** application and select the **Smart Diagnosis** feature in the menu. Follow the instructions for audible diagnosis provided in the **LG ThinQ** application.

- 1 Open the **LG ThinQ** application on the smart phone.
- 2 In the application, select the appliance from your list of connected appliances and then press the dots at the upper right of the screen.
- 3 Select **Smart Diagnosis**, then press the **Start Smart Diagnosis** button.

NOTE

- If the diagnosis fails several times, use the following instructions.

- 4 Select the **Audible Diagnosis**.
- 5 Follow the instructions on the smart phone.
- 6 Keep the phone in place until the tone transmission has finished. View the diagnosis on the phone.

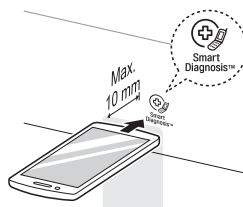

NOTE

- For best results, do not move the phone while the tones are being transmitted.

MAINTENANCE

Cleaning the Glass-Ceramic Cooktop

CAUTION

- Do not use scrub pads or abrasive cleaning pads. They may damage your cooktop surface.
- For your safety, wear an oven mitt or pot holder while using a scraper on the hot cooking surface.
- Read and follow all instructions and warnings on the cleaning cream label.

Use ceramic cooktop cleaner on the glass cooktop. Other creams may not be as effective or may scratch, damage or stain the cooktop surface.

To maintain and protect the surface of the glass cooktop, follow these steps:

- 1 Before using the cooktop for the first time, clean it with a ceramic cooktop cleaner. This helps protect the top and makes cleanup easier.
- 2 Use ceramic cooktop cleaner daily to help keep the cooktop looking new.
- 3 Shake the cleaning cream well. Apply a few drops of cleaner directly to the cooktop.
- 4 Use a paper towel to clean the entire cooktop surface.
- 5 Rinse with clear water and use a dry cloth or paper towel to remove all cleaning residue.

NOTE

Do not heat the cooktop until it has been cleaned thoroughly.

IMPORTANT

If any sugar or food containing sugar (preserves, ketchup, tomato sauce, jellies, fudge, candy, syrups, chocolate) spills, or plastic or foil melts on the cooktop, remove the molten material IMMEDIATELY with a metal razor scraper (it will not damage the decorated cooking surface) while the cooking surface is still hot to avoid the risk of damage to the glass-ceramic surface. For your safety, please use an oven mitt or pot holder while scraping the hot cooking surface.

NOTE

Sugary spillovers (such as preserves, ketchup, tomato sauce, jellies, fudge, candy, syrups, chocolate) or melted plastics can cause pitting of the surface of your cooktop.
(Not covered by the warranty)

Burned-On Residue

- 1 While the cooktop is still hot, remove any burnt on deposits or spilled food from the glass-ceramic cooking surface with a suitable metal razor scraper. (Similar to scraping paint off of a windowpane, it will not damage the decorated cooking surface.) Hold the scraper at an approximate 30° angle to the cooktop.

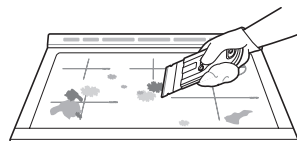

NOTE

- Do not use a dull or nicked blade.
- To prevent burns, wear an oven mitt or pot holder while using the metal scraper.

- 2 When the cooking surface has cooled down, apply a few dabs (about the size of a dime) of a ceramic glass cooktop cleaner in each burner area and work the cleaning cream over the cooktop surface with a damp paper towel.

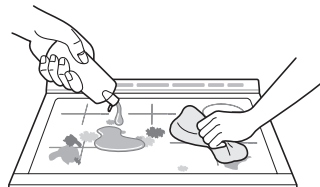

NOTE

Approved cleaners

- Weiman Cooktop Cleaning Cream (www.weiman.com)
- Cerama Bryte (www.ceramabryte.com)
- Golden Ventures Cerama Bryte
- Easy-Off 3 in 1 Glass Top Cleaner Spray (www.easyoff.us)

- 3 Rinse with clean water and wipe the cooktop surface with a clean, dry paper towel.

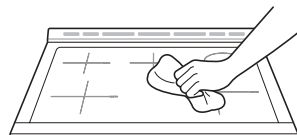

Maintaining the Cooktop

DO NOT use chlorine bleach, ammonia, or other cleaners not specifically recommended for use on glass-ceramic cooktops.

Let your glass-ceramic cooking surface cool off before cleaning.

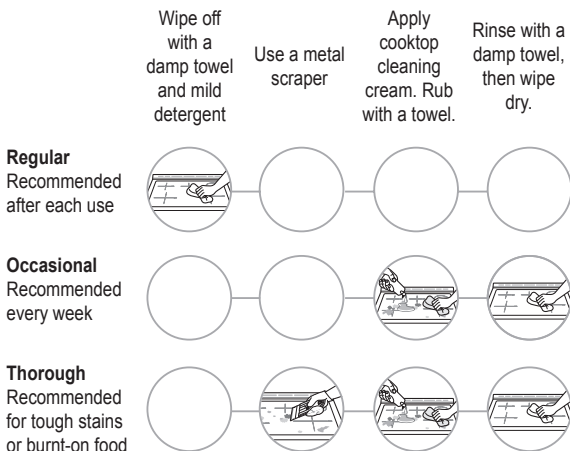

For additional product information, visit our website at www.lg.com

Metal Marks and Scratches

- 1 Be careful not to slide pots and pans across the cooktop. Doing so will leave metal markings on the cooktop surface.
- 2 To help remove these marks, use a ceramic cooktop cleaner with a cleaning pad for ceramic cooktops.

CAUTION

Cookware with rough or uneven bottoms can mark or scratch the cooktop surface.

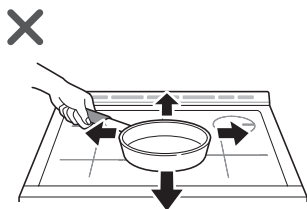

- Do not slide metal or glass across the cooktop surface.
- Do not use cookware with any dirt build-up on the bottom.

EasyClean®

LG's EasyClean® enamel technology provides two cleaning options for the inside of the range. The EasyClean® feature takes advantage of LG's new enamel to help lift soils without harsh chemicals, and it runs using **ONLY WATER** for just 10 minutes in low temperatures to help loosen **LIGHT** soils before hand-cleaning.

While EasyClean® is quick and effective for small and **LIGHT** soils, the Self Clean feature can be used to remove **HEAVY**, built up soils. The intensity and high heat of the Self Clean cycle may result in smoke which will require the opening up of windows to provide ventilation. Compared to the more intense Self Clean process, your LG oven gives you the option of cleaning with **LESS HEAT**, **LESS TIME**, and virtually **NO SMOKE OR FUMES**.

When needed, the range still provides the self clean option for longer, more thorough oven cleaning for heavier, built up soils.

Benefits of EasyClean®

- Helps loosen light soils before hand-cleaning
- EasyClean® only uses water; no chemical cleaners
- Makes for a better self-clean experience
 - Delays the need for a self-clean cycle
 - Minimizes smoke and odors
 - Can allow shorter self-clean time

When to Use EasyClean®

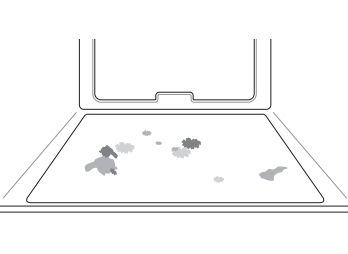
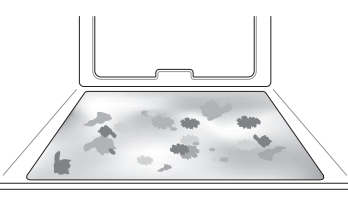
Suggested Cleaning Method	Example of Oven Soiling	Soil Pattern	Types of Soils	Common Food Items That Can Soil Your Oven
EasyClean®		Small drops or spots	Cheese or other ingredients	Pizza
		Light splatter	Fat/grease	Steaks, broiled
				Fish, broiled
				Meat roasted at low temperatures
Self Clean*		Medium to heavy splatter	Fat/grease	Meat roasted at high temperatures
		Drops or spots	Filling or sugar based soils	Pies
			Cream or tomato sauce	Casseroles

* The Self Clean cycle can be used for soil that has been built up over time.

Cleaning Tips

- Allow the oven to cool to room temperature before using the EasyClean® cycle. If your oven cavity is above 150 °F (65 °C), **Hot** will appear in the display, and the EasyClean® cycle will not be activated until the oven cavity cools down.
- A plastic spatula can be used as a scraper to scrape off any chunks or debris before and during oven cleaning.
- Using the rough side of a non-scratch scouring pad may help to take off burnt-on stains better than a soft sponge or towel.
- Certain non-scratch scrubbing sponges, such as those made of melamine foam, available at your local stores, can also help improve cleaning.
- The range should be level to ensure that the bottom surface of the oven cavity is entirely covered by water at the beginning of the EasyClean® cycle.
- For best results, use distilled or filtered water. Tap water may leave mineral deposits on the oven bottom.
- Soil baked on through several cooking cycles will be more difficult to remove with the EasyClean® cycle.
- Do not open the oven door during the EasyClean® cycle. Water will not get hot enough if the door is opened during the cycle.
- For hard to reach areas such as the back surface of the oven, it is better to use the Self Clean cycle.

EasyClean® Instruction Guide

- 1 Remove oven racks and accessories from the oven.
- 2 Scrape off and remove any burnt-on debris with a plastic scraper.

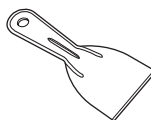

Suggested plastic scrapers:

- Hard plastic spatula
- Plastic pan scraper
- Plastic paint scraper
- Old credit card

- 3 Fill a spray bottle (10 oz or 300 ml) with water and use the spray bottle to thoroughly spray the inside surfaces of the oven.
- 4 Use at least 1/5 (2 oz or 60 ml) of the water in the bottle to completely saturate the soil on both the walls and in the corners of the oven.

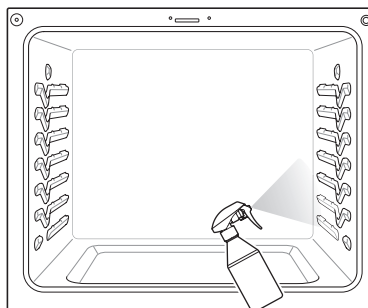

- 5** Spray or pour the remaining water (8 oz or 240 ml) onto the bottom center of the oven cavity. The indentation on the oven bottom should be fully covered to submerge all soils. Add water if necessary.

NOTE

If cleaning multiple ovens, use an entire bottle of water to clean each oven. Do not spray water directly on the door. Doing so will result in water dripping to the floor.

- 6** Close the oven door.
Turn the oven mode knob to select **EasyClean®**. Press **Start**.

CAUTION

- Some surfaces may be hot after the EasyClean® cycle. Wear rubber gloves while cleaning to prevent burns.
- During the EasyClean® cycle, the oven becomes hot enough to cause burns. Wait until the cycle is over before wiping the inside surface of the oven. Failure to do so may result in burns.
- Avoid leaning or resting on the oven door glass while cleaning the oven cavity.

- 7** A tone will sound at the end of the 10 minute cycle. Turn the oven mode knob to the **Off** position to clear the display and end the tone.

- 8** After the cleaning cycle and during hand-cleaning, enough water should remain on the oven bottom to completely submerge all soils. Add water if necessary. Place a towel on the floor in front of the oven to capture any water that may spill out during hand-cleaning.

- 9** Clean the oven cavity immediately after the EasyClean® cycle by scrubbing with a wet, non-scratch scouring sponge or pad. (The scouring side will not scratch the finish.) Some water may spill into the bottom vents while cleaning, but it will be captured in a pan under the oven cavity and will not hurt the burner.

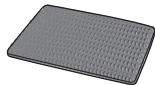
**NOTE**

Do not use any steel scouring pads, abrasive pads or cleaners as these materials can permanently damage the oven surface.

- 10** Once the oven cavity is cleaned, wipe any excess water with a clean dry towel. Replace racks and any other accessories.

- 11** If some light soils remain, repeat the above steps, making sure to thoroughly soak the soiled areas. If stubborn soils remain after multiple EasyClean® cycles, run the Self Clean cycle. Be sure that the oven cavity is empty of oven racks and other accessories, and that the oven cavity surface is dry before running the Self Clean cycle. Consult the Self Clean section of your owner's manual for further details.

NOTE

- If you forget to saturate the inside of the oven with water before starting EasyClean®, turn the Oven mode knob to the **Off** position to end the cycle. Wait for the range to cool to room temperature and then spray or pour water into the oven and start another EasyClean® cycle.
- The cavity gasket may be wet when the EasyClean® cycle finishes. This is normal. Do not clean the gasket.
- If mineral deposits remain on the oven bottom after cleaning, use a cloth or sponge soaked in vinegar to remove them.
- It is normal for the fan to operate during the EasyClean® cycle.

Self Clean

The Self Clean cycle uses extremely hot temperatures to clean the oven cavity. While running the Self Clean cycle, you may notice smoking or an odor. This is normal; especially if the oven is heavily soiled.

During Self Clean, the kitchen should be well ventilated to minimize the odors from cleaning.

Before Starting Self Clean

- Remove the oven racks, broiler pan, broiler grid, all cookware, aluminum foil or any other material from the oven.
- The kitchen should be well ventilated to minimize the odors from cleaning.
- Wipe any heavy spills on the bottom of the oven.
- Make sure that the oven light bulb cover is in place and the oven light is off.
- The oven light cannot be turned on during a Self Clean cycle. The oven light cannot be turned on until the oven temperature has cooled below 500 °F (260 °C) after a Self Clean cycle is complete.



CAUTION

- Do not leave small children unattended near the appliance. During the Self Clean cycle, the outside of the range can become very hot to the touch.
- If you have pet birds, move them to another well-ventilated room. The health of some birds is extremely sensitive to the fumes given off during the Self Clean cycle of any range.
- Do not line the oven walls, racks, bottom or any other part of the range with aluminum foil or any other material. Doing so will destroy heat distribution, produce poor baking results and cause permanent damage to the oven interior (aluminum foil will melt to the interior surface of the oven).
- Do not force the door open. This can damage the automatic door locking system. Use care when opening the oven door after the Self Clean cycle. Stand to the side of the oven when opening the door to allow hot air or steam to escape. The oven may still be VERY HOT.

During the Self Clean cycle, the cooktop elements and warming drawer cannot be used.

NOTE

- Remove oven racks and accessories before starting the Self Clean cycle.
- If oven racks are left in the oven cavity during the Self Clean cycle, they will discolor and become difficult to slide in and out.
- Clean the frame of the oven and door with hot soapy water. Rinse well.
- Do not clean the gasket. The fiberglass material of the oven door gasket cannot withstand abrasion. It is essential for the gasket to remain intact. If you notice it becoming worn or frayed, replace it.
- Wipe up any heavy spills on the oven bottom.
- Make sure that the oven light bulb cover is in place and the oven light is off.
- It is normal for the fan to operate during the Self Clean cycle.
- The **Burner On** indicator light turns on when the knob is turned even if the cooktop element does not operate.

Setting Self Clean

The Self Clean function has cycle times of 3, 4, or 5 hours.

Self Clean Soil Guide

Soil Level	Cycle Setting
Lightly Soiled Oven Cavity	3-Hour Self Clean
Moderately Soiled Oven Cavity	4-Hour Self Clean
Heavily Soiled Oven Cavity	5-Hour Self Clean

- 1 Remove all racks and accessories from the oven.
- 2 Turn the oven mode knob to select **Self Clean**. The oven defaults to the recommended four-hour self clean for a moderately soiled oven. Press **plus(+)** or **minus(-)** to select a self clean time from 3 to 5 hours.
- 3 Press **Start**.
- 4 Once the self-clean cycle is set, the oven door locks automatically and the lock icon displays. You will not be able to open the oven door until the oven has cooled. The lock releases automatically when the oven has cooled.

**CAUTION**

Do not force the oven door open when the lock icon is displayed. The oven door remains locked until the oven temperature has cooled. Forcing the door open will damage the door.

Setting Self Clean with a Delayed Start

- 1 Remove all racks and accessories from the oven.
- 2 Turn the oven mode knob to select **Self Clean**. The oven defaults to the recommended four-hour self clean for a moderately soiled oven. Press **plus(+)** or **minus(-)** to select a self clean time from 3 to 5 hours.
- 3 Press **Start Time**.
- 4 Press **plus(+)** or **minus(-)** to enter the time of day you would like the Self Clean to start.
- 5 Press **Start**.

NOTE

It may become necessary to cancel or interrupt a Self Clean cycle due to excessive smoke or fire in the oven. To cancel the Self Clean function, turn the oven mode knob to the **Off** position.

During Self Clean

- The Self Clean cycle uses extremely hot temperatures to clean the oven cavity. While running the Self Clean cycle, you may notice smoking or an odor. This is normal, especially if the oven is heavily soiled.
- As the oven heats, you may hear sounds of metal parts expanding and contracting. This is normal and will not damage the oven.
- Do not force the oven door open when the lock  is displayed. The oven door remains locked until the oven temperature has cooled. Forcing the door open will damage the door.

After the Self Clean Cycle

- The oven door remains locked until the oven temperature has cooled.
- You may notice some white ash in the oven. Wipe it off with a damp cloth or a soap-filled steel wool pad after the oven cools. If the oven is not clean after one self-clean cycle, repeat the cycle.
- If oven racks were left in the oven and do not slide smoothly after a self-clean cycle, wipe racks and rack supports with a small amount of vegetable oil to make them glide more easily.
- Fine lines may appear in the porcelain because it went through heating and cooling. This is normal and will not affect performance.

NOTE

- The Self Clean cycle cannot be started if the Lockout feature is active.
- Once the Self Clean cycle is set, the oven door locks automatically. You will not be able to open the oven door until the oven is cooled. The lock releases automatically.
- Once the door has been locked, the lock  indicator light stops flashing and remains on. Allow about 15 seconds for the oven door lock to activate.
- If the clock is set for a 12-hour display (default) the Delayed Self Clean can never be set to start more than 12 hours in advance.
- After the oven is turned off, the convection fan keeps operating until the oven has cooled down.

Changing the Oven Light

The oven light is a standard 40-watt, 120 V appliance bulb. It turns on when the oven door is open. When the oven door is closed, press **Light** to turn it on or off.

- 1 Unplug the range or disconnect power.
- 2 Turn the glass bulb cover in the back of the oven counterclockwise to remove.
- 3 Turn the bulb counterclockwise to remove it from the socket.
- 4 Insert the new bulb and turn it clockwise.
- 5 Insert the glass bulb cover and turn it clockwise.
- 6 Plug in the range or reconnect the power.

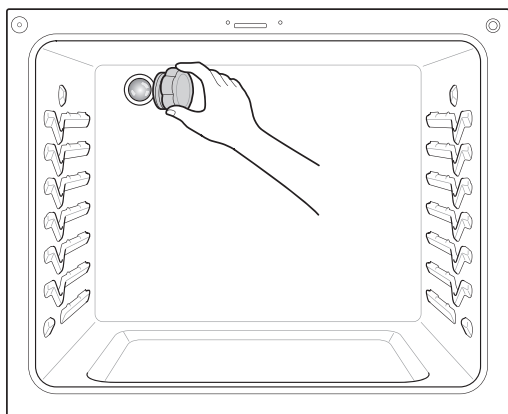

WARNING

- Make sure that the oven and bulb are cool.
- Disconnect the electrical power to the range at the main fuse or circuit breaker panel. Failure to do so can result in severe personal injury, death, or electrical shock.

Cleaning the Exterior

Painted and Decorative Trim

For general cleaning, use a cloth with hot soapy water. For more difficult soils and built-up grease, apply a liquid detergent directly onto the soil. Leave it on for 30 to 60 minutes. Rinse with a damp cloth and dry. Do not use abrasive cleaners.

Stainless Steel Surfaces

To avoid scratches, do not use steel wool pads.

- 1 Place a small amount of stainless steel appliance cleaner or polish on a damp cloth or paper towel.
- 2 Clean a small area, rubbing with the grain of the stainless steel if applicable.
- 3 Dry and buff with a clean, dry paper towel or soft cloth.
- 4 Repeat as necessary.

Oven Door

- Use soapy water to thoroughly clean the oven door. Rinse well. Do not immerse the door in water.
- You may use a glass cleaner on the outside glass of the oven door. Do not spray water or glass cleaner on the door vents.
- Do not use oven cleaners, cleaning powders, or harsh abrasive cleaning materials on the outside of the oven door.
- Do not clean the oven door gasket. The oven door gasket is made of a woven material that is essential for a good seal. Care should be taken not to rub, damage, or remove this gasket.

CAUTION

Do not use harsh cleaners or harsh abrasive cleaning materials on the outside of the oven door. Doing so can cause damage.

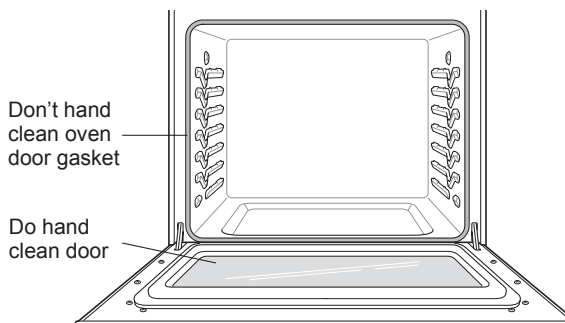

Broiler Pan and Grid

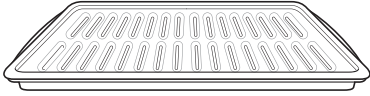

- Do not store a soiled broiler pan or grid anywhere in the range.
- Do not clean the broiler pan or grid in a self-cleaning mode.
- Remove the grid from the pan. Carefully pour out the grease from the pan into a proper container.
- Wash and rinse the broiler pan and grid in hot water with a soap-filled or plastic scouring pad.
- If food has burned on, sprinkle the grid with cleaner while hot and cover with wet paper towels or a dishcloth. Soaking the pan will remove burned-on foods.
- Both the broiler pan and grid may be cleaned with a commercial oven cleaner or in the dishwasher.

Removing and Replacing the Lift-Off Oven Doors and Drawer



CAUTION

- Be careful when removing and lifting the door.
- Do not lift the door by the handle. The door is very heavy.

Removing the Door

- 1 Fully open the door.
- 2 Unlock the hinge locks, rotating them as far toward the open door frame as they will go.

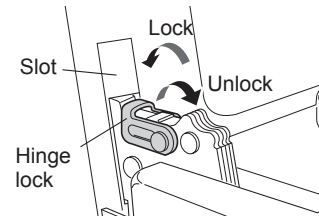

- 3 Firmly grasp both sides of the door at the top.
- 4 Close the door to the removal position (approximately five degrees) which is halfway between the broil stop position and fully closed. If the position is correct, the hinge arms will move freely.

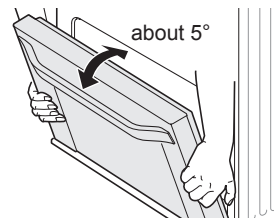

- 5 Lift door up and out until the hinge arms are clear of the slots.

Replacing the Door

- 1 Firmly grasp both sides of the door at the top.
- 2 With the door at the same angle as the removal position, seat the indentation of the hinge arms into the bottom edge of the hinge slots. The notch in the hinge arms must be fully seated into the bottom edge of the slots.

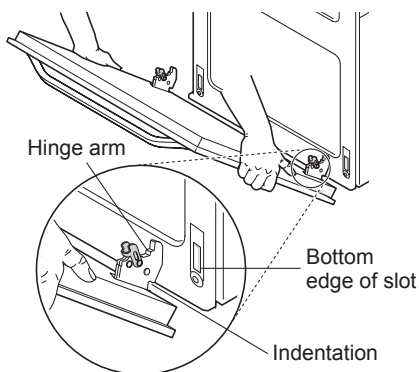

- 3 Open the door fully. If the door will not open fully, the indentation is not seated correctly in the bottom edge of the slots.
- 4 Lock the hinge locks, rotating them back toward the slots in the oven frame until they lock.

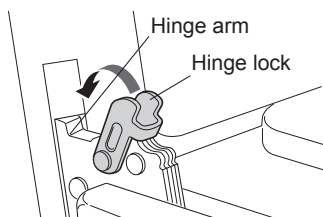

- 5 Close the oven door.

Removing the Drawer

CAUTION

Disconnect the electrical power to the range at the main fuse or circuit breaker panel. Failure to do so can result in severe personal injury, death, or electrical shock.

Most cleaning can be done with the drawer in place; however, the drawer may be removed if further cleaning is needed. Use warm water to thoroughly clean.

- 1 Fully open the drawer.
- 2 Locate the glide lever on each side of the drawer. Push down on the left glide lever and pull up on the right glide lever.

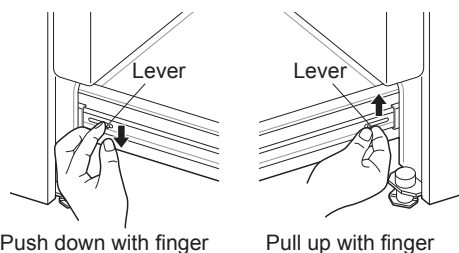

- 3 While holding both levers, carefully pull the drawer away from the range.

Replacing the Drawer

- 1 Pull the bearing glides to the front of the chassis glide.
- 2 Align the glide on each side of the drawer with the glide slots on the range.
- 3 Push the drawer into the range until levers click (approximately 2 inch).
- 4 Pull the drawer open again to seat bearing glides into position.

Door Care Instructions

Most oven doors contain glass that can break.

CAUTION

- Do not close the oven door until all the oven racks are fully in place.
- Do not hit the glass with pots, pans, or any other object.
- Scratching, hitting, jarring, or stressing the glass may weaken its structure causing an increased risk of breakage at a later time.

TROUBLESHOOTING

FAQs

What types of cookware are recommended for use with the cooktop?

- Look for cookware that is marked "induction ready" or "induction capable" or that is specifically designed for induction cooking.
- The cookware must have a magnetic metallic base. See the Induction Cookware Types section.
- The pans must have a flat bottom and straight sides.
- Only use heavy-gauge pans.
- The pan size must match the amount of food to be prepared and the size of the surface element.
- Use tight fitting lids.
- Only use flat-bottom woks.

Why do the heating elements appear to be turning ON and OFF during use of the cooktop or oven?

Depending on your cooktop element setting or the temperature selected in your oven it is NORMAL for the cooking elements to cycle on and off.

My new oven doesn't cook like my old one. Is there something wrong with the temperature settings?

No, your oven has been factory tested and calibrated. For the first few uses, follow your recipe times and temperatures carefully. If you still think your new oven is too hot or too cold, you can adjust the oven temperature yourself to meet your specific cooking needs. Refer to the Oven Temperature Adjustment section in this manual for easy instructions on how to adjust your thermostat.

Is it normal to hear a clicking noise coming from the back of my oven when I am using it?

Your new range is designed to maintain a tighter control over your oven's temperature. You may hear your oven's heating elements click on and off more frequently on your new oven. This is NORMAL.

Why is the colon in the clock flashing?

This means that the product has just been plugged in, or that it has experienced a power interruption. To clear the flashing colon in the clock, press any key or reset the clock if needed.

During convection cooking the fan stops when I open the door. Is that normal?

Yes, this is normal. When the door is opened, the convection fan will stop until the door is closed.

Can I use aluminum foil to catch drippings in my oven cavity?

Never use aluminum foil to line the bottom or sides of the oven or the warming drawer. The foil will melt and stick to the bottom surface of the oven and will not be removable. Use a sheet pan placed on a lower oven rack to catch drippings instead. (If foil has already melted onto the bottom of the oven, it will not interfere with the oven's performance.)

Can I use aluminum foil on the racks?

Do not cover racks with aluminum foil. Covering entire racks with foil restricts air flow, leading to poor cooking results. Use a sheet pan lined with foil under fruit pies or other acidic or sugary foods to prevent spillovers from damaging the oven finish.



CAUTION

Foil may be used to wrap food in the oven or warming drawer, but do not allow the foil to come into contact with the exposed heating/broiling elements in the oven. The foil could melt or ignite, causing smoke, fire, or injury.

Can I leave my racks in the oven when running a Self Clean cycle?

No. Although it will not damage the racks, it will discolor them and may make them hard to slide in and out during use. Remove all items from the oven before starting a Self Clean cycle.

What should I do if my racks are sticky and have become hard to slide in and out?

Over time, the racks may become hard to slide in and out. Apply a small amount of olive oil to the ends of the racks. This will work as a lubricant for easier gliding.

What should I do for hard to remove stains on my cooktop?

The cooktop should be cleaned after every use to prevent permanent staining. When cooking foods with high sugar content, such as tomato sauce, clean the stain off with a scraper while the cooktop is still warm. Use an oven mitt when scraping to prevent burns. Refer to the MAINTENANCE section of this owner's manual for further instruction.

Why aren't the function buttons working?

Make sure that the range is not in Lockout mode. The lock  will show in the display if Lockout is activated. To deactivate Lockout, press **Probe** (LSE4617 model only), or **Clock** for three seconds. The unlock melody sounds and **Loc** appears in the display until the controls are unlocked.

My range is still dirty after running the EasyClean® cycle. What else should I do?

The EasyClean® cycle only helps to loosen light soils in your oven range to assist in hand-cleaning of your oven. It does not automatically remove all soils after the cycle. Some scrubbing of your oven range is required after running the EasyClean® cycle.

I tried scrubbing my oven after running EasyClean®, but some soils still remain. What can I do?

The EasyClean® feature works best when the soils are fully soaked and submerged in water before running the cycle and during hand-cleaning. If soils are not sufficiently soaked in water, it can negatively affect the cleaning performance. Repeat the EasyClean® process using sufficient water. Sugar-based and certain greasy soils are especially hard to clean. If some stubborn soils remain, use the Self Clean feature to thoroughly clean your oven.

Soils on my oven walls are not coming off. How can I get my walls clean?

Soils on the side and rear walls of your oven range may be more difficult to fully soak with water. Try repeating the EasyClean® process with more than the ¼ cup (2 oz or 60 ml) spray recommended.

Will EasyClean® get all of the soils and stains out completely?

It depends on the soil type. Sugar-based and certain grease stains are especially hard to clean. Also, if stains are not sufficiently soaked in water, this can negatively affect cleaning performance. If stubborn or built-up stains remain, use the Self Clean feature. Refer to the Self Clean section of your owner's manual.

Are there any tricks to getting some of the stubborn soils out?

Scraping the soils with a plastic scraper before and during hand-cleaning is recommended. Fully saturating soils with water is also recommended. However, certain types of soils are harder to clean than others. For these stubborn soils, the Self Clean cycle is recommended. Consult the Self Clean section of your owner's manual for details.

Is it safe for my convection fan, broil burner or heater element to get wet during EasyClean®?

Yes. The convection fan, broiler burner or heater element may get a little wet during cleaning. However, direct spray onto the broil burner and heater elements is not necessary because these are self-cleaning during regular use.

Do I need to use all 1¼ cups (10 oz or 300 ml) of water for EasyClean®?

Yes. It is highly recommended that 1 cup (8 oz or 240 ml) of water be sprayed or poured on the bottom and an additional ¼ cup (2 oz or 60 ml) of water be sprayed on walls and other soiled areas to fully saturate the soils for better cleaning performance.

I see smoke coming out of my oven range's cooktop vents during EasyClean®. Is this normal?

This is normal. This is not smoke. It is actually water vapor (steam) from the water in the oven cavity. As the oven heats briefly during EasyClean®, the water in the cavity evaporates and escapes through the oven vents.

How often should I use EasyClean®?

EasyClean® can be performed as often as you wish. EasyClean® works best when your oven is LIGHTLY soiled from such things as LIGHT grease splatter and small drops of cheese. Please refer to the EasyClean® section in your owner's manual for more information.

What is required for EasyClean®?

A spray bottle filled with 1¼ cups (10 oz or 300 ml) of water, a plastic scraper, a non-scratch scrubbing pad and a towel. You should not use abrasive scrubbers such as heavy-duty scouring pads or steel wool. Except for a towel, all of the materials you need are included in a special cleaning kit with your new range.

How can I help keep children safe around the range?

Children should be supervised around the range whenever it is in use, and after use until surfaces have cooled. You can also use the Lockout feature to help prevent children from accidentally turning on the cooktop or oven. The Lockout feature disables most control panel buttons and the cooktop control knobs. On some models, it also locks the oven door. Consult the Lockout section of your owner's manual for details.

(In models without a self-clean option, the Lockout feature locks the controls but does not lock the oven door.)

Before Calling for Service

Before you call for service, review this list. It may save you time and expense. The list includes common occurrences that are not the result of defective workmanship or materials in this appliance.

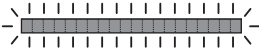
Symptoms	Possible Causes / Solutions										
Range is not level.	<ul style="list-style-type: none"> • Poor installation. Place oven rack in center of oven. Place a level on the oven rack. Adjust leveling legs at base of range until the oven rack is level. • Be sure floor is level and strong and stable enough to adequately support range. • If floor is sagging or sloping, contact a carpenter to correct the situation. • Kitchen cabinet alignment may make range appear unlevel. Be sure cabinets are square and have sufficient room for range clearance. 										
Cannot move appliance easily. Appliance must be accessible for service.	<ul style="list-style-type: none"> • Cabinets not square or are built in too tightly. Contact builder or installer to make appliance accessible. • Carpet interferes with range. Provide sufficient space so range can be lifted over carpet. • Anti-tip device engaged. 										
Oven control beeps and displays any F code error.	<ul style="list-style-type: none"> • Electronic control has detected a fault condition. Turn the Oven mode knob to the Off position to clear the display and stop beeping. Reprogram oven. If fault recurs, record fault number. Turn the Oven mode knob to the Off position and call for service. <table border="1" data-bbox="856 680 1300 819"> <thead> <tr> <th>CODE</th> <th>CAUSE</th> </tr> </thead> <tbody> <tr> <td>F-3</td> <td>Key short error</td> </tr> <tr> <td>F-9</td> <td>Oven not heating</td> </tr> </tbody> </table>	CODE	CAUSE	F-3	Key short error	F-9	Oven not heating				
CODE	CAUSE										
F-3	Key short error										
F-9	Oven not heating										
Surface element control beeps and entire LED bar flashes. 	<ul style="list-style-type: none"> • Electric control has detected a fault condition. Turn the control knob to the Off position to clear the display and stop the beeping. Call for service. <table border="1" data-bbox="856 880 1300 1190"> <thead> <tr> <th>Number of Flashes</th> <th>CAUSE</th> </tr> </thead> <tbody> <tr> <td>1</td> <td>Top Thermistor Open/Short</td> </tr> <tr> <td>2</td> <td>Heatsink Thermistor Open/Short</td> </tr> <tr> <td>3</td> <td>Communication error</td> </tr> <tr> <td>4</td> <td>Box fan not working</td> </tr> </tbody> </table>	Number of Flashes	CAUSE	1	Top Thermistor Open/Short	2	Heatsink Thermistor Open/Short	3	Communication error	4	Box fan not working
Number of Flashes	CAUSE										
1	Top Thermistor Open/Short										
2	Heatsink Thermistor Open/Short										
3	Communication error										
4	Box fan not working										
Surface units will not maintain a rolling boil or cooking is not fast enough	<ul style="list-style-type: none"> • Improper cookware being used. <ul style="list-style-type: none"> - Use pans which are flat and match the diameter of the surface unit selected. • In some areas, the power(voltage) may be low. <ul style="list-style-type: none"> - Cover pan with a lid until desired heat is obtained. 										
Surface units do not work properly	<ul style="list-style-type: none"> • A fuse in your home may be blown or the circuit breaker tripped. <ul style="list-style-type: none"> - Replace the fuse or reset the circuit breaker. • Cooktop controls improperly set. <ul style="list-style-type: none"> - Check to see the correct control is set for the surface unit you are using. • Cookware is the wrong size or is not induction capable. <ul style="list-style-type: none"> - See Induction Cookware section for more information. • The maximum operating time for all element levels except the Boost mode is 12 hours. 										
Areas of discoloration on the cooktop	<ul style="list-style-type: none"> • Food spillovers not cleaned before next use. <ul style="list-style-type: none"> - See Cleaning the Glass-Ceramic Cooktop section. • Hot surface on a model with a light-colored cooktop. <ul style="list-style-type: none"> - This is normal. The surface may appear discolored when it is hot. This is temporary and will disappear as the glass cools. 										

Symptoms	Possible Causes / Solutions
Frequent cycling on and off of surface units	<ul style="list-style-type: none"> • This is normal. <ul style="list-style-type: none"> - The element will cycle on and off to maintain the heat setting.
Oven will not work	<ul style="list-style-type: none"> • Plug on range is not completely inserted in the electrical outlet. <ul style="list-style-type: none"> - Make sure electrical plug is plugged into a live, properly grounded outlet. • A fuse in your home may be blown or the circuit breaker tripped. <ul style="list-style-type: none"> - Replace the fuse or reset the circuit breaker. • Oven controls improperly set. <ul style="list-style-type: none"> - See the Using the Oven section. • Oven too hot. <ul style="list-style-type: none"> - Allow the oven to cool to below locking temperature.
Steam is exhausted through the oven vent.	<ul style="list-style-type: none"> • Cooking foods with high moisture produces steam. This is normal.
Appliance does not operate.	<ul style="list-style-type: none"> • Make sure cord is plugged correctly into outlet. Check circuit breakers. • Service wiring is not complete. Contact your electrician for assistance. • Power outage. Check house lights to be sure. Call your local electric company for service.
Oven light does not work.	<ul style="list-style-type: none"> • Replace or tighten bulb. See Changing the Oven Light section in this Owner's Manual.
Oven smokes excessively during broiling.	<ul style="list-style-type: none"> • Control not set properly. Follow instructions under Setting Oven Controls. • Meat too close to the element. Reposition the rack to provide proper clearance between the meat and the element. Preheat broil element for searing. • Meat not properly prepared. Remove excess fat from meat. Cut remaining fatty edges to prevent curling. • Insert on broiler pan wrong side up and grease not draining. Always place grid on the broiler pan with ribs up and slots down to allow grease to drip into pan. • Grease has built up on oven surfaces. Regular cleaning is necessary when broiling frequently. <ul style="list-style-type: none"> - Old grease or food spatters cause excessive smoking.
Food does not bake or roast properly	<ul style="list-style-type: none"> • Oven controls improperly set. <ul style="list-style-type: none"> - See the Using the Oven section. • Rack position is incorrect or the rack is not level. <ul style="list-style-type: none"> - See the Using the Oven section. • Incorrect cookware or cookware of improper size being used. <ul style="list-style-type: none"> - See the Using the Oven section. • Oven sensor needs to be adjusted. <ul style="list-style-type: none"> - See Oven Temperature Adjustment in the Features section.
Food does not broil properly	<ul style="list-style-type: none"> • Oven controls improperly set. <ul style="list-style-type: none"> - Make sure you turn the oven mode knob to select the Broil mode. • Improper rack position being used. <ul style="list-style-type: none"> - See the Broiling Guide. • Cookware not suited for broiling. <ul style="list-style-type: none"> - Use broiling pan and grid. • Aluminum foil used on the broiling pan and grid has not been fitted properly and slit as recommended. <ul style="list-style-type: none"> - See the Using the Oven section. • In some areas the power voltage may be low. <ul style="list-style-type: none"> - Preheat the broil element for 5-7 minutes. - See the Broiling Guide.

Symptoms	Possible Causes / Solutions
Oven temperature too hot or too cold	<ul style="list-style-type: none"> Oven sensor needs to be adjusted. <ul style="list-style-type: none"> See Oven Temperature Adjustment in the Features section.
Scratches or abrasions on cooktop surface	<ul style="list-style-type: none"> Coarse particles such as salt or sand between cooktop and utensils can cause scratches. Be sure the cooktop surface and bottoms of utensils are clean before using. Small scratches do not affect cooking and will become less visible with time. Cleaning materials not recommended for glass-ceramic cooktop have been used. See Cleaning the Glass-Ceramic Cooktop in the MAINTENANCE section. Cookware with rough bottom has been used. Use smooth, flat-bottomed cookware.
Metal marks	<ul style="list-style-type: none"> Scraping of metal utensils on cooktop surface. Do not slide metal utensils on cooktop surface. Use a glass-ceramic cooktop cleaning creme to remove the marks. See Cleaning the Glass-Ceramic Cooktop in the MAINTENANCE section.
Brown streaks or specks	<ul style="list-style-type: none"> Boilovers are cooked onto surface. Use a blade scraper to remove soil. See Cleaning the Glass-Ceramic Cooktop in the MAINTENANCE section.
Areas of discoloration on cooktop	<ul style="list-style-type: none"> Mineral deposits from water and food. Remove using a glass-ceramic cooktop cleaning creme. Use cookware with clean, dry bottoms.
Oven will not Self Clean	<ul style="list-style-type: none"> The oven temperature is too high to set a Self Clean operation. <ul style="list-style-type: none"> Allow the range to cool and reset the controls. Oven controls improperly set. <ul style="list-style-type: none"> See the Self Clean section. A Self Clean cycle cannot be started if the oven lockout feature is active.
“Crackling” or “popping” sound	<ul style="list-style-type: none"> This is the sound of the metal heating and cooling during both the cooking and Self Clean functions. <ul style="list-style-type: none"> This is normal.
Fan noise	<ul style="list-style-type: none"> The convection fan and cooktop fan may automatically cycle on and off. <ul style="list-style-type: none"> This is normal. The cooktop fan may turn on to reduce the temperature of the product, even when the surface elements are not being used.
Convection Fan stops	<ul style="list-style-type: none"> Convection fan stops during a convection bake cycle. <ul style="list-style-type: none"> This is normal and is done to allow for more even heating during the cycle. This is not a failure of the range and should be considered normal operation.
Displayed colon in the clock is flashing	<ul style="list-style-type: none"> This is normal. This means that the product has just been plugged in, or that it has experienced a power interruption. Press Cook Time for three seconds and reset the clock, or press any key to stop the flashing.
Excessive smoking during a Self Clean cycle	<ul style="list-style-type: none"> Excessive soil. <ul style="list-style-type: none"> Turn the oven mode knob to the Off position. Open the windows to rid the room of smoke. Wait until the Self Clean mode is cancelled. Wipe up the excess soil and reset the clean.
Oven door does not open after a Self Clean cycle	<ul style="list-style-type: none"> Oven is too hot. <ul style="list-style-type: none"> Allow the oven to cool below locking temperature. Allow about one hour for the oven to cool after the completion of a Self Clean cycle. The door can be opened when the lock  is no longer displayed. The control and door may be locked.

Symptoms	Possible Causes / Solutions
The oven does not clean after a Self Clean cycle	<ul style="list-style-type: none"> • Oven controls not properly set. <ul style="list-style-type: none"> - See the Self Clean section. • Oven was heavily soiled. <ul style="list-style-type: none"> - Clean up heavy spills before starting the clean cycle. Heavily soiled ovens may need to Self Clean again or for a longer period of time.
CLEAN and door flash in the display	<ul style="list-style-type: none"> • The Self Clean cycle has been selected, but the door is not closed. <ul style="list-style-type: none"> - Close the oven door.
LOCKED is on in the display when you want to cook	<ul style="list-style-type: none"> • The oven door is locked because the temperature inside the oven has not dropped below the locking temperature. <ul style="list-style-type: none"> - Turn the oven mode knob to the Off position. Allow the oven to cool.
Burning or oily odor emitting from the vent	<ul style="list-style-type: none"> • This is normal in a new oven and will disappear in time. <ul style="list-style-type: none"> - To speed the process, set a Self Clean cycle for a minimum of 3 hours. See the Self Clean section.
Oven racks are difficult to slide	<ul style="list-style-type: none"> • The shiny, silver-colored racks were cleaned in a Self Clean cycle. <ul style="list-style-type: none"> - Apply a small amount of vegetable oil to a paper towel and wipe the edges of the oven racks with the paper towel.
Moisture collects on oven window or steam comes from oven vent	<ul style="list-style-type: none"> • This is normal when cooking foods high in moisture. • Excessive moisture was used when cleaning the window.
Wifi network does not connect properly.	<ul style="list-style-type: none"> • If the appliance is having trouble connecting to the Wi-Fi network, it may be too far from the router. Purchase a Wi-Fi repeater (range extender) to improve the Wi-Fi signal strength. • The Wi-Fi connection may not connect or may be interrupted because of the home network environment. • The network connection may not work properly depending on the internet service provider. • The surrounding wireless environment can make the wireless network service run slowly.
Surface elements frequently cycle on and off.	<ul style="list-style-type: none"> • The element will cycle on and off to maintain level of power it has been set at. This is normal operation and not a system failure.
Trouble connecting appliance and smartphone to Wi-Fi network	<ul style="list-style-type: none"> • The password for the Wi-Fi network was entered incorrectly. <ul style="list-style-type: none"> - Delete your home Wi-Fi network and begin the registration process again. • Mobile data for your smartphone is turned on. <ul style="list-style-type: none"> - Turn off the Mobile data on your smartphone before registering the appliance. • The wireless network name (SSID) is set incorrectly. <ul style="list-style-type: none"> - The wireless network name (SSID) should be a combination of English letters and numbers. (Do not use special characters.) • The router frequency is not 2.4 GHz. <ul style="list-style-type: none"> - Only a 2.4 GHz router frequency is supported. Set the wireless router to 2.4 GHz and connect the appliance to the wireless router. To check the router frequency, check with your Internet service provider or the router manufacturer. • The distance between the appliance and the router is too far. <ul style="list-style-type: none"> - If the appliance is too far from the router, the signal may be weak and the connection may not be configured correctly. Move the router closer to the appliance or purchase and install a Wi-Fi repeater.

LIMITED WARRANTY (USA)

ARBITRATION NOTICE: THIS LIMITED WARRANTY CONTAINS AN ARBITRATION PROVISION THAT REQUIRES YOU AND LG TO RESOLVE DISPUTES BY BINDING ARBITRATION INSTEAD OF IN COURT, UNLESS YOU CHOOSE TO OPT OUT. IN ARBITRATION, CLASS ACTIONS AND JURY TRIALS ARE NOT PERMITTED. PLEASE SEE THE SECTION TITLED "PROCEDURE FOR RESOLVING DISPUTES" BELOW.

Should your LG Electric Range ("Product") fail due to a defect in materials or workmanship under normal and proper use, during the warranty period set forth below, LG Electronics ("LG") will, at its option, repair or replace the Product. This limited warranty is valid only to the original retail purchaser of the Product and applies only when purchased and used within the United States including U.S. Territories.

Warranty Period	Scope of Warranty	HOW SERVICE IS HANDLED
Two (2) year from date of original retail purchase	Parts and Labor (internal / functional parts only)	LG will provide, free of charge, all labor and in-home service to replace defective part(s).

- Replacement products and parts are warranted for the remaining portion of the original warranty period or ninety (90) days, whichever is greater.
- Replacement products and parts may be new, reconditioned, refurbished, or otherwise factory remanufactured.
- Proof of original retail purchase specifying the Product model and date of purchase is required to obtain warranty service under this limited warranty.

EXCEPT TO THE EXTENT PROHIBITED BY APPLICABLE LAW, ANY IMPLIED WARRANTY OF MERCHANTABILITY OR FITNESS FOR A PARTICULAR PURPOSE ON THE PRODUCT IS LIMITED IN DURATION TO THE DURATION OF THE ABOVE LIMITED WARRANTY. UNDER NO CIRCUMSTANCES SHALL LG OR ITS U.S. DISTRIBUTORS/DEALERS BE LIABLE FOR ANY INDIRECT, INCIDENTAL, CONSEQUENTIAL, SPECIAL, OR PUNITIVE DAMAGES, INCLUDING, WITHOUT LIMITATION, LOST GOODWILL, LOST REVENUES OR PROFITS, WORK STOPPAGE, IMPAIRMENT OF OTHER GOODS, COST OF REMOVAL AND REINSTALLATION OF THE PRODUCT, LOSS OF USE, OR ANY OTHER DAMAGES WHETHER BASED IN CONTRACT, TORT, OR OTHERWISE. LG'S TOTAL LIABILITY, IF ANY, SHALL NOT EXCEED THE PURCHASE PRICE PAID BY YOU FOR THE PRODUCT.

Some states do not allow the exclusion or limitation of incidental or consequential damages or limitations on how long an implied warranty lasts, so the above exclusions or limitations may not apply to you. This limited warranty gives you specific legal rights and you may also have other rights that vary from state to state.

THIS LIMITED WARRANTY DOES NOT COVER:

- Service trips to deliver, pick up, or install, educate how to operate, correct wiring, or correct unauthorized repairs.
- Damage or failure of the Product to perform during power failures and interrupted or inadequate electrical service.
- Damage or failure resulting from operating the Product in a corrosive atmosphere or contrary to the Product owner's manual.
- Damage or failure to the Product caused by accidents, pests and vermin, lightning, wind, fire, floods, acts of God, or any other causes beyond the control of LG.
- Damage or failure caused by unauthorized modification or alteration, or if used for other than the intended purpose.
- Damage or failure resulting from misuse, abuse, improper installation, repair, or maintenance. Improper repair includes use of parts not authorized by LG. Improper installation or maintenance includes installation or maintenance contrary to the Product owner's manual.
- Damage or failure caused by incorrect electrical current, voltage, or ventilation/plumbing codes.
- Damage or failure caused by transportation and handling, including scratches, dents, chips, and/or other damage to the finish of the Product, unless such damage is reported within one (1) week of delivery.
- Damage or missing items to any display, open box, or discounted Product.
- Refurbished Product or any Product sold "As Is", "Where Is", "With all Faults", or similar disclaimer.
- Products with original serial numbers that have been removed, altered, or cannot be readily determined.
- Increases in utility costs and additional utility expenses.

- Any noises associated with normal operation.
- Use of accessories, components, or consumable cleaning products that are not authorized by LG.
- Replacement of light bulbs, filters, or any consumable parts.
- When Product is used for other than normal and proper household use (e.g. commercial or industrial use, offices, and recreational facilities or vehicles) or contrary to the Product's owner's manual.
- Costs associated with removal and reinstallation of your Product for repairs.
- Shelves, drawers and accessories, except for internal/functional parts covered under this limited warranty.

Not Covered by this Limited Warranty

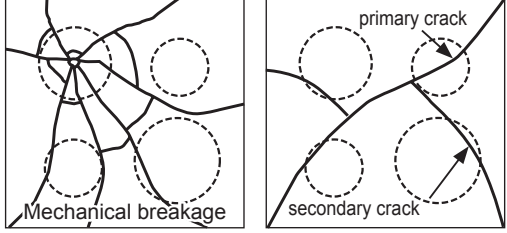
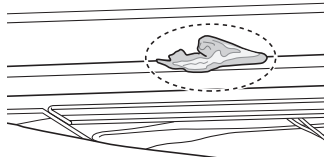
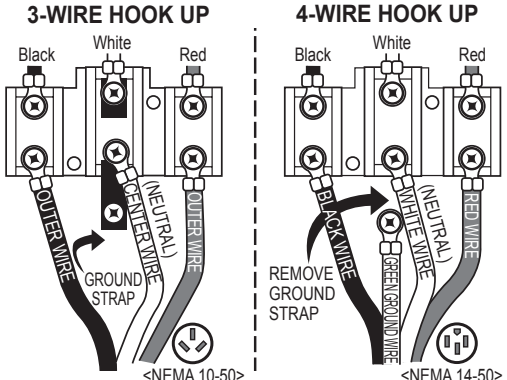
Problem	Cause	Prevention
<ul style="list-style-type: none"> • Cooktop crack 	<p>Cooktop crack caused by impact of object</p>  <p>out of warranty in warranty</p> <ul style="list-style-type: none"> • Damage caused after delivery (Not covered by warranty) 	<ul style="list-style-type: none"> • DO NOT store heavy items above the cooktop surface as they could fall and damage it. • DO NOT scratch the cooktop or the cooktop could crack. • Clean the cooktop before and after using.
<ul style="list-style-type: none"> • Cooktop enamel chipping off 	<p>Improper usage</p> 	<ul style="list-style-type: none"> • Do not hit the enamel cooktop.
<ul style="list-style-type: none"> • Pitting of the cooktop glass 	<ul style="list-style-type: none"> • If not removed immediately, sugary spillovers (such as preserves, ketchup, tomato sauce, jellies, fudge, candy, syrups, or chocolate) or melted plastic or foil can cause surface pitting of the cooktop. (Not covered by warranty) 	<ul style="list-style-type: none"> • Remove the molten material IMMEDIATELY with a metal razor scraper. • For safety, wear an oven mitt or hot pad while scraping the hot surface.
<ul style="list-style-type: none"> • Unit has no power 	<ol style="list-style-type: none"> 1. House power turned off (power supply) 2. Tripped breaker 3. The power cord is not installed properly.  <p>3-WIRE HOOK UP 4-WIRE HOOK UP</p> <p><NEMA 10-50> <NEMA 14-50></p>	<ul style="list-style-type: none"> • Check power at main board before calling for service. • Match power cord type and outlet type • Properly install the power cord

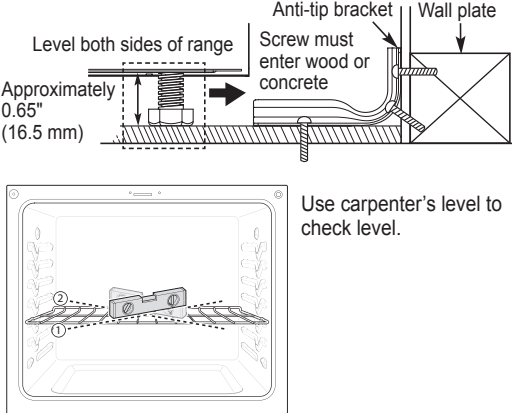
Problem	Cause	Prevention
<ul style="list-style-type: none"> Oven or racks are stained after using aluminum foil 	<p>Aluminum foil has melted in the oven</p> 	<ul style="list-style-type: none"> Never cover the oven bottom or cover an entire rack with materials such as aluminum foil. If the foil has already melted onto the oven, it will not affect the performance of the oven.
<ul style="list-style-type: none"> Surface is not level Oven is tipping 	<ol style="list-style-type: none"> Range not leveled Anti-tip device not installed correctly  <p>Use carpenter's level to check level.</p>	<ul style="list-style-type: none"> Check with installer first

The cost of repair or replacement under the above excluded circumstances shall be borne by the consumer.

TO OBTAIN WARRANTY SERVICE AND ADDITIONAL INFORMATION

Call 1-800-243-0000 and select the appropriate option from the menu.

Or visit our website at <http://www.lg.com>

Or by mail: LG Electronics Customer Service P.O. Box 240007 Huntsville, AL 35813 ATTN: CIC

PROCEDURE FOR RESOLVING DISPUTES:

ALL DISPUTES BETWEEN YOU AND LG ARISING OUT OF OR RELATING IN ANY WAY TO THIS LIMITED WARRANTY OR THE PRODUCT SHALL BE RESOLVED EXCLUSIVELY THROUGH BINDING ARBITRATION, AND NOT IN A COURT OF GENERAL JURISDICTION. BINDING ARBITRATION MEANS THAT YOU AND LG ARE EACH WAIVING THE RIGHT TO A JURY TRIAL AND TO BRING OR PARTICIPATE IN A CLASS ACTION.

Definitions. For the purposes of this section, references to “LG” mean LG Electronics U.S.A., Inc., its parents, subsidiaries and affiliates, and each of their officers, directors, employees, agents, beneficiaries, predecessors in interest, successors, assigns and suppliers; references to “dispute” or “claim” shall include any dispute, claim or controversy of any kind whatsoever (whether based in contract, tort, statute, regulation, ordinance, fraud, misrepresentation or any other legal or equitable theory) arising out of or relating in any way to the sale, condition or performance of the product or this Limited Warranty.

Notice of Dispute. In the event you intend to commence an arbitration proceeding, you must first notify LG in writing at least 30 days in advance of initiating the arbitration by sending a letter to LG at LG Electronics, USA, Inc. Attn: Legal Department- Arbitration 111 Sylvan Avenue, Englewood Cliffs, NJ07632. You and LG agree to engage in good faith discussions in an attempt to amicably resolve your claim. The notice must provide your name, address, and telephone number; identify the product that is the subject of the claim; and describe the nature of the claim and the relief being sought. If you and LG are unable to resolve the dispute within 30 days, either party may proceed to file a claim for arbitration.

Agreement to Binding Arbitration and Class Action Waiver. Upon failure to resolve the dispute during the 30 day period after sending written notice to LG, you and LG agree to resolve any claims between us only by binding arbitration on an individual basis, unless you opt out as provided below. Any dispute between you and LG shall not be combined or consolidated with a dispute involving any other person's or entity's product or claim. More specifically, without limitation of the foregoing, any dispute between you and LG shall not under any circumstances proceed as part of a class or representative action. Instead of arbitration, either party may bring an individual action in small claims court, but that small claims court action may not be brought on a class or representative basis.

Arbitration Rules and Procedures. To begin arbitration of a claim, either you or LG must make a written demand for arbitration. The arbitration will be administered by the American Arbitration Association ("AAA") and will be conducted before a single arbitrator under the AAA's Consumer Arbitration Rules that are in effect at the time the arbitration is initiated (referred to as the "AAA Rules") and under the procedures set forth in this section. The AAA Rules are available online at www.adr.org/consumer. Send a copy of your written demand for arbitration, as well as a copy of this provision, to the AAA in the manner described in the AAA Rules. You must also send a copy of your written demand to LG at LG Electronics, USA, Inc. Attn: Legal Department- Arbitration 111 Sylvan Avenue, Englewood Cliffs, NJ07632. If there is a conflict between the AAA Rules and the rules set forth in this section, the rules set forth in this section will govern. This arbitration provision is governed by the Federal Arbitration Act. Judgment may be entered on the arbitrator's award in any court of competent jurisdiction. All issues are for the arbitrator to decide, except that issues relating to the scope and enforceability of the arbitration provision and to the arbitrability of the dispute are for the court to decide. The arbitrator is bound by the terms of this provision.

Governing Law. The law of the state of your residence shall govern this Limited Warranty and any disputes between us except to the extent that such law is preempted by or inconsistent with applicable federal law.

Fees/Costs. You do not need to pay any fee to begin an arbitration. Upon receipt of your written demand for arbitration, LG will promptly pay all arbitration filing fees to the AAA unless you seek more than \$25,000 in damages, in which case the payment of these fees will be governed by the AAA Rules. Except as otherwise provided for herein, LG will pay all AAA filing, administration and arbitrator fees for any arbitration initiated in accordance with the AAA Rules and this arbitration provision. If you prevail in the arbitration, LG will pay your attorneys' fees and expenses as long as they are reasonable, by considering factors including, but not limited to, the purchase amount and claim amount. Notwithstanding the foregoing, if applicable law allows for an award of reasonable attorneys' fees and expenses, an arbitrator can award them to the same extent that a court would. If the arbitrator finds either the substance of your claim or the relief sought in the demand is frivolous or brought for an improper purpose (as measured by the standards set forth in Federal Rule of Civil Procedure 11(b)), then the payment of all arbitration fees will be governed by the AAA Rules. In such a situation, you agree to reimburse LG for all monies previously disbursed by it that are otherwise your obligation to pay under the AAA Rules. Except as otherwise provided for, LG waives any rights it may have to seek attorneys' fees and expenses from you if LG prevails in the arbitration.

Hearings and Location. If your claim is for \$25,000 or less, you may choose to have the arbitration conducted solely on the basis of (1) documents submitted to the arbitrator, (2) through a telephonic hearing, or (3) by an in-person hearing as established by the AAA Rules. If your claim exceeds \$25,000, the right to a hearing will be determined by the AAA Rules. Any in-person arbitration hearings will be held at a location within the federal judicial district in which you reside unless we both agree to another location or we agree to a telephonic arbitration.

Opt Out. You may opt out of this dispute resolution procedure. If you opt out, neither you nor LG can require the other to participate in an arbitration proceeding. To opt out, you must send notice to LG no later than 30 calendar days from the date of the first consumer purchaser's purchase of the product by either: (i) sending an e-mail to optout@lge.com, with the subject line: "Arbitration Opt Out" or (ii) calling 1-800-980-2973. You must include in the opt out e-mail or provide by telephone: (a) your name and address; (b) the date on which the product was purchased; (c) the product model name or model number; and (d) the serial number (the serial number can be found (i) on the product; or (ii) online by accessing <https://www.lg.com/us/support/repair-service/schedule-repair-continued> and clicking on "Find My Model & Serial Number").

You may only opt out of the dispute resolution procedure in the manner described above (that is, by e-mail or telephone); no other form of notice will be effective to opt out of this dispute resolution procedure. Opting out of this dispute resolution procedure will not affect the coverage of the Limited Warranty in any way, and you will continue to enjoy the full benefits of the Limited Warranty. If you keep this product and do not opt out, then you accept all terms and conditions of the arbitration provision described above.



LG Customer Information Center

1-800-243-0000 USA

Register your product Online!

www.lg.com