

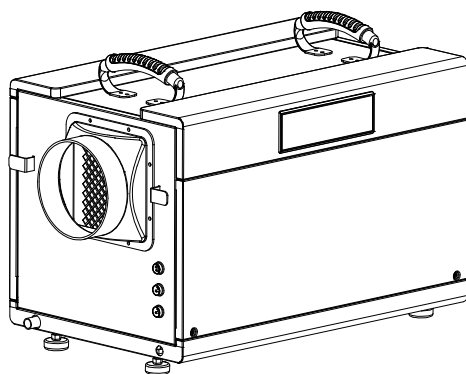

Commercial Dehumidifier User Manual



Please read this user manual before operating and save for future reference.

Model: DY145

BEFORE FIRST USE:

Please leave the dehumidifier sitting outside the box for **24 HOURS** before plugging it in.

The dehumidifiers may have been tilted or placed upside down during shipping. Leave The dehumidifier sits for 24 hours so the oil in the compressor can settle from the move, Not doing so can affect the performance or lifespan of the dehumidifier.

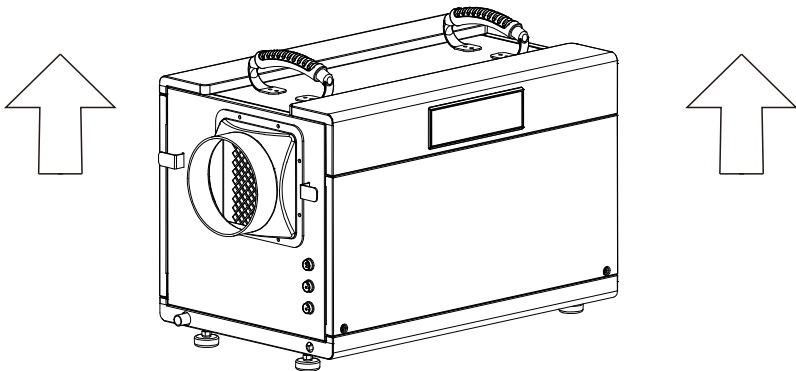

NOTE:

To continuously improve its products, LUBAIR reserves the right to modify this information without prior notification. For any questions during assembly, please check the instructions on the product page for reference. Or contact our customer service with any questions, comments, or concerns , We are online 24H for you. Thank you for using LUBAIR products in your home!

Welcome

Thanks for choosing **LUBAIR** dehumidifier!

LUBAIR is dedicated to keeping people healthy, comfortable and more enjoyable by offering quality appliances ranging from dehumidifiers to ice makers, and more. From breathing easier in your office to upgrading your kitchen appliances, we hope **LUBAIR** could help you every step of the way.

**READ THIS MANUAL INSTRUCTION CAREFULLY BEFORE USING THE UNIT.
PLEASE KEEP THIS FOR FUTURE REFERENCE.**

LUBAIR DY145 commercial dehumidifier can remove 145 PPD at saturation (95°F, 90% RH) and 68 PPD at AHAM (80°F, 60% RH) , reducing humidity to comfortable levels in a short period of time. This dehumidifier has a metal housing to withstand harsh environments, is safe and easy to use, guarantees long-term use and easy maintenance, plus we use a copper tube condenser and high quality and accurate sensors, it will be more effective and last longer.

When we design this dehumidifier, we fully consider the needs of different consumers, We design compact Smaller size, a strong carrying handle for easy handling; can be used directly or through our optional remote control system lifting use, the machine outlet with flange mouth, can be connected to the duct system. Automatic defrost system, optional remote control system, and all other features make it ideal for underground spaces, basements, crawl spaces, and commercial applications. We do hope you'll enjoy the dehumidifier you purchased from us.

Before plugging in your new dehumidifier, we suggest that you read this user manual as it contains important safety information, operation instructions, troubleshooting, maintenance tips, and warranty information to ensure the reliability and longevity of your dehumidifier.

We're always just an email away

To access customer support, please email to LubairServices@outlook.com with your purchase order.

Thank you again!

Table of Contents

Introduction.....	1
Safety Awareness.....	2
Instructions For Repairing Appliances Containing.....	5
Machine Structure Diagram.....	7
Operation Instruction.....	8
Drain Water.....	11
Maintenance.....	13
Parts List & Schematic diagram of flange installation.....	14
Troubleshooting.....	16
Safety Precautions.....	17
Service.....	18

Introduction

Thank you for choosing the dehumidifier by LUBAIR!

We hope it will bring great convenience to your work and life.

We recommend that you save the user manual properly for future reference.

Before using this product, please read the user manual carefully to ensure that this product functions at its best.

The LUBAIR's dehumidifier adopt an upgraded design, compact structure, easy to operate, and other characteristics, widely used in scientific research, basement, crawl space, greenery, laboratory, gymnasium, sanitation, commodity storage, underground engineering, and dehumidification in high humidity places such as kitchens, bathrooms, archives, warehouses, etc. Can be effectively avoided telecommunications equipment, materials, etc, are damaged due to dampness or rust.

Transportation and Custody

During transportation, this product should be handled preciously to prevent violent vibration. Generally, the packaged product should not be stored in the open air for a long time. It should be placed in a well-ventilated, non-corrosive gas warehouse. It should not be placed upside down. Rainproof measures should be adopted when stored temporarily.

Safety Awareness

VERY IMPORTANT!

Please do not install or use your dehumidifier before you have carefully read this manual. Please keep this instruction manual for an eventual product warranty and for future reference.

Warning

Do not use means to accelerate the defrosting process or to clean, other than those recommended by the manufacturer.

The appliance shall be stored in a room without continuously operating ignition sources (for example: open flames, an operating gas appliance or an operating electric heater.)

Do not pierce or burn.

Be aware the refrigerants may not contain an odour.



A2L

Warning(for R32)

Specific information regarding appliances with R32 refrigerant gas.

- Thoroughly read all of the warnings.
- When defrosting and cleaning the appliance, do not use any tools other than those recommended by the manufacturing company.
- The appliance must be placed in an area without any continuously sources of ignition(for example: open flames, gas or electrical appliances in operation).
- Do not puncture and do not burn.
- R32 is a refrigerant gas that complies with the United States directives on the environment.Do not, puncture any part of the refrigerant circuit.
- If the appliance is installed, operated or stored in an unventilated area, the room must be designed to prevent to the accumulation of refrigerant leaks resulting in a risk of fire or explosion due to ignition of the refrigerant caused by electric heaters, stoves, or other sources of ignition.
- The appliance must be stored in such a way as to prevent mechanical failure.
- Individuals who operate or work on the refrigerant circuit must have the appropriate certification issued by an accredited organization that ensures competence in handling refrigerants according to a specific evaluation recognized by associations in the industry.

-
- Repairs must be performed based on the recommendation from the manufacturing company. Maintenance and repairs that require the assistance of other qualified personnel must be performed under the supervision of an individual specified in the use of flammable refrigerants.
 - Ducts connected to an appliance shall not contain a potential ignition source.
 - WARNING-Risk Of Fire. Flammable Refrigerant Used. To Be Repaired Only By Trained Service Personnel. Do Not Puncture Refrigerant Tubing.
 - WARNING-Risk Of Fire. Dispose Of Properly In Accordance With Federal Or Local Regulations. Flammable Refrigerant Used.
 - WARNING-Risk Of Fire. Flammable Refrigerant Used. Consult Repair Manual/Owner's Guide Before Attempting To Service This Product. All Safety Precautions Must Be Followed.
 - WARNING-Risk of Fire due to Flammable Refrigerant Used. Follow Handling Instructions Carefully in Compliance with National Regulations.

General Safety Instruction

1. The appliance is for indoor use only.
2. Do not use the unit on a socket under repairs or not installed properly
3. Do not use the unit, follow these precautions:
 - A: Near to source of fire.
 - B: An area where oil is likely to splash.
 - C: An area exposed to direct sunlight.
 - D: An area where water is likely to splash.
4. All the air-conditioner sockets must comply with the local electric safety requirements. If necessary, please check it for the requirements.
5. Children should be supervised to ensure that they do not play with the appliance.
6. If the supply cord is damaged, it must be replaced by the manufacturer, its service agent or similarly qualified persons in order to avoid a hazard.
7. This appliance can be used by children aged from 8 years and above and persons with reduced physical, sensory or mental capabilities or lack of experience and knowledge if they have been given supervision or instruction concerning use of the appliance in a safe way and understand the hazards involved. Children shall not play with the appliance. Cleaning and user maintenance shall not be made by children without supervision.
8. This appliance is not intended for use by persons (including children) with reduced physical, sensory or mental capabilities, or lack of experience and knowledge, unless they have been given supervision or instruction concerning use of the appliance by a person responsible for their safety.

-
9. The appliance shall be installed in accordance with national wiring regulations.
10. Recycling



- This marking indicates that this product should not be disposed with other household wastes. To prevent possible harm to the environment or human health from uncontrolled waste disposal recycle it responsibly to promote the sustainable reuse of material resources. To return your used device, please use the return and collection systems or contact the retailer where the product was purchased. They can take this product for environmental safe recycling.
11. Contact authorized service technician for repair or maintenance of this unit.
12. Do not pull deform. or modify the power supply cord, or immerse it in water. Pulling or misuse of the power supply cord can result in damage to the unit and cause electrical shock.
13. Compliance with national gas regulations shall be observed.
14. Keep ventilation openings clear of obstruction.
15. Any person who is involved with working on or breaking into a refrigerant circuit should hold a current valid certificate from an industry-accredited assessment authority, which authorizes their competence to handle refrigerants safely in accordance with an industry recognized assessment specification.
16. Servicing shall only be performed as recommended by the equipment manufacturer.
- Maintenance and repair requiring the assistance of other skilled personnel shall be carried out under the supervision of the person competent in the use of flammable refrigerants.
17. Do not operate or stop the unit by inserting or pulling out Die power plug, it may cause electric shock or fire due to heat generation.
18. Unplug the unit if strange sounds, smell, or smoke comes from it.

- If any parts damage, please contact the dealer or a designated repair shop;
- In case of any damage, please turn off the air switch, disconnect the power supply, and contact the dealer or a designated repair shop;
- In any case, the power cord shall be firmly grounded.
- To avoid the possibility of danger, if power cord is damaged, please turn off the air switch and disconnect the power supply. It must be replaced from the dealer or a designated repair shop.

Instructions For Repairing Appliances Containing R32

General Instructions

- Checks to the area Prior to beginning work on systems containing flammable refrigerants, safety checks are necessary to ensure that the risk of ignition is minimised. For repair to the refrigerating system, the following precautions shall be complied with prior to conducting work on the system.
- Ventilated area Ensure that the area is in the open or that it is adequately ventilated before breaking into the system or conducting any hot work. A degree of ventilation shall continue during the period that the work is carried out. The ventilation should safely disperse any released refrigerant and preferably expel it externally into the atmosphere.

Detection of flammable refrigerants

- Under no circumstances shall potential sources of ignition be used in the searching for or detection of refrigerant leaks. A halide torch (or any other detector using a naked flame) shall not be used.
- The following leak detection methods are deemed acceptable for all refrigerant systems.
- Electronic leak detectors may be used to detect refrigerant leaks but, in the case of FLAMMABLE REFRIGERANTS, the sensitivity may not be adequate, or may need re-calibration. (Detection equipment shall be calibrated in a refrigerant-free area.) Ensure that the detector is not a potential source of ignition and is suitable for the refrigerant used. Leak detection equipment shall be set at a percentage of the LFL of the refrigerant and shall be calibrated to the refrigerant employed, and the appropriate percentage of gas (25 % maximum) is confirmed.
- Leak detection fluids are also suitable for use with most refrigerants but the use of detergents containing chlorine shall be avoided as the chlorine may react with the refrigerant and corrode the copper pipe-work.

Note Examples of leak detection fluids are

- bubble method,
- fluorescent method agents.

If a leak is suspected, all naked flames shall be removed/extinguished. If a leakage of refrigerant is found which requires brazing, all of the refrigerant shall be recovered from the system, or isolated (by means of shut off valves) in a part of the system remote from the leak.

Safety Information

- Install the dehumidifier on flat surface to minimize vibration and or noise.
- Inspect the power cord before use. Never operate the dehumidifier when the power cord or plug is damaged.
- Insert the three-prong plug on the power cord into a matching electrically grounded outlet (115V/ 60 Hz, 16 A at least).
- Do not use an adapter. Never cut off the third prong. Do not use an extension cord.
- Do not operate the dehumidifier in standing water. Keep motor and wiring dry.
- Never immerse the dehumidifier into water or other liquids.
- Do not put the dehumidifier close to heat-generating devices, including flammable or dangerous materials.
- Unplug the power supply before cleaning or storing the dehumidifier. Always grasp the plug (not the cord) to unplug.
- Do not put fingers or other items into air inlet or air outlet.
- Never insert any other objects into the dehumidifier body.
- Do not sit, stand or put heavy objects on the dehumidifier.



Never repair or remove plug and or power cord. Any repairs should be completed by qualified electrician or distributor.

Machine Structure Diagram

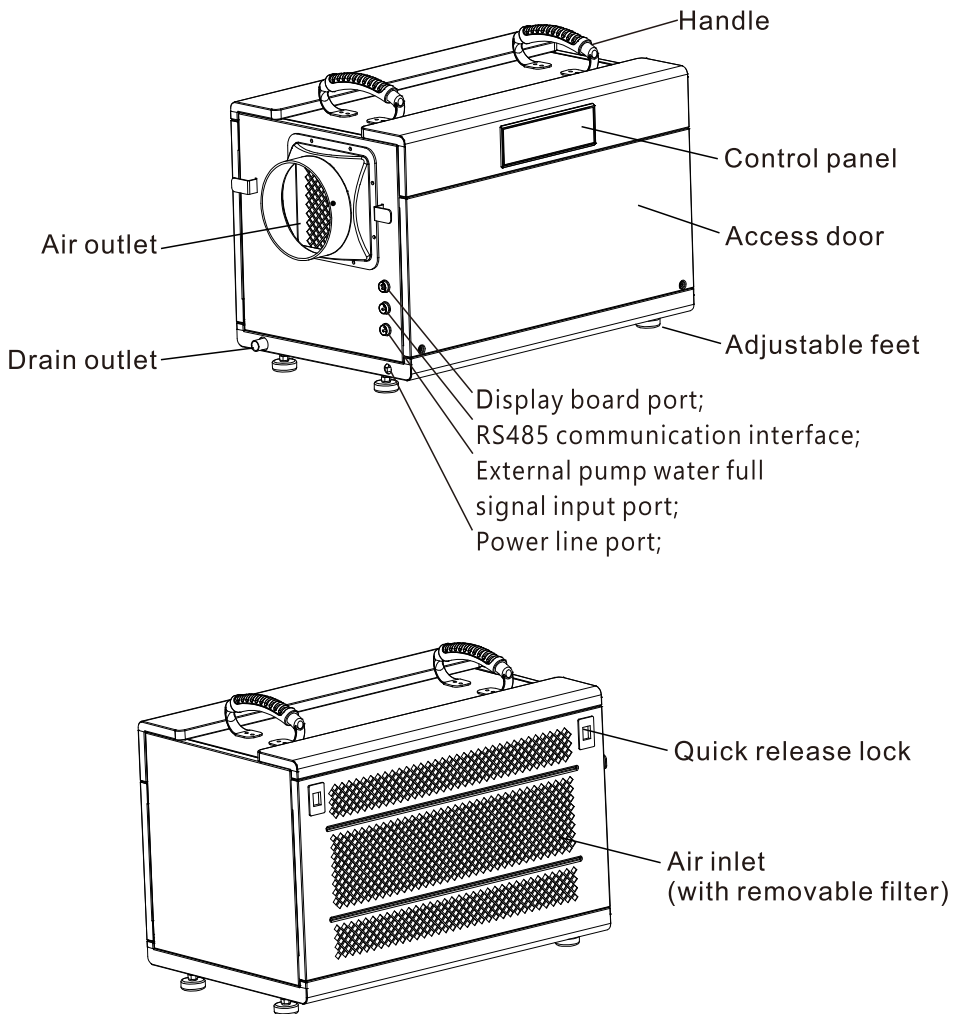

NOTE: There May be slight differences in the model, the actual machine shall prevail.

Operation Instruction

Operation panel

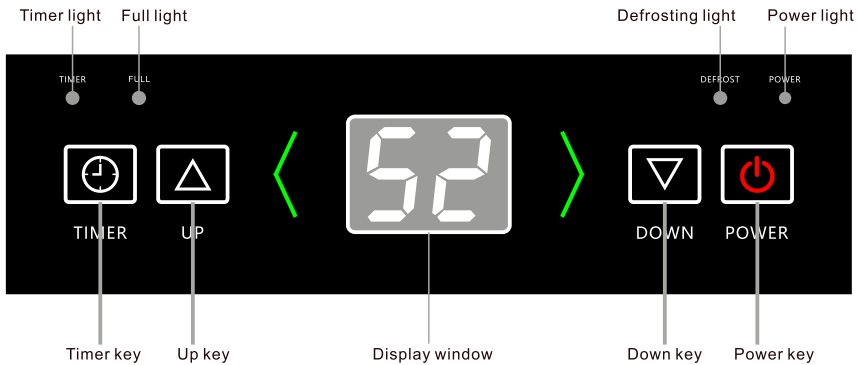

Key description:

1. Power switch key: In the shutdown state, press once to turn on the machine, otherwise turn off the machine.
2. Up key: Increase the humidity setting value.
3. Down key: decrease the humidity setting value.
4. Timer key: used to set the timing time.

Humidity setting:

In the power-on state, press the "Up" or "Down" key once to enter the humidity setting state: the display screen flashes the humidity setting value "* *". In the humidity setting state, press the "Up" or "Down" key to set the humidity, and the setting range is 10-98% RH. After the key operation is stopped for a few seconds, the humidity setting state is automatically exited.

Timer setting:

In the power-off state, the timer is set to timed power-on. In the power-on state, the timer is set to timed power-off. Press the "Timer key" to set the timer time. The timer time will increase by 1h every time you press it. The setting range is 1 ~ 24h, which can be set circularly. Press and hold the "timer key" for several seconds to continuously adjust the timer time; if the timer time is 00, the timer is invalid.

When the timer is valid, the timer indicator is on. Press the "timer key" once, and the display screen will display the remaining timer time.

After a few seconds, the current humidity value will be automatically displayed.

Action description:

Startup: the fan is turned on, and the compressor 1 is turned on with a delay of several seconds.

Shutdown: the compressor is stopped immediately, and the fan is stopped after a delay of several seconds.

Without turning on the power supply, the compressor can be turned on again after it stops running for 3 minutes.

Defrosting function:

When operating at low ambient temperature, the system will automatically judge whether there is frost, and if there is frost, it will automatically defrost.

Defrosting action: the fan does not stop and the compressor stops.

End of defrosting: the defrosting indicator is off, and the fan and compressor operate according to the humidity control requirements.

Defrost display: when defrosting, the defrosting indicator is on.

Fault Code

S/N	Fault code	Fault name
1	E _c (Ec)	The display board communication is abnormal

(Whether the above fault codes exist depends on whether the actual model has this function.)

Notice:

1. In case of Ec fault, the machine operation is not controlled by the operation panel.

Water Full Protection Function

In the power-on state, when the dehumidifier receives the water full signal from the external water pump.

- 1)Water Full Action: the compressor stops running immediately, and the fan stops running after a delay of 3 minutes
- 2)Water Full Signal Remove: the fan and compressor operate according to the humidity control requirements humidity .

Temperature Protection Function

- 1)When the ambient temperature is higher than the high temperature setting value (default 113 °F / 45°C), the system enters high temperature protection, prompts "HH", and the compressor stops running;
- 2)When the ambient temperature is lower than the low temperature setting value (default 39°F / 4°C), the system enters the low temperature protection, prompts "LL", and the dehumidifier stops running;

State Description

- 1)**Power On:** The fan starts running, and the compressor starts to run after a delay of a few seconds.
- 2)**Power Off:** The compressor stops running immediately, and the fan stops after a few seconds delay.
- 3)To prevent the machine from starting and stopping frequently, there is a 3-minute delay in the start-up interval.

Turn The Dehumidifier Off

Press the Power Switch to turn the dehumidifier off.

Note: To protect the compressor, the fan will continue to operate for 5 seconds after the dehumidifier has shut off. So please do not disconnect the power cord to force the dehumidifier to stop. Always use the power button.

Drain Water

Dehumidifiers Adopt Drain by Gravity, the collected condensation water can be drained by gravity.

When using gravity to drain:

- 1) Connect the drain hose to the Gravity Drain Outlet;
- 2) Place the unattached end of the hose in a suitable drainage facility. The drainage facility should be lower than the drain outlet of the dehumidifier. (Ensure there are no kinks or other obstructions that will stop the water to flow.)

Note:

- 1) If you use a bucket or other container for water collection, check it regularly to prevent overflows.
- 2) Connecting a drain hose that is too long is not recommended, as it may cause water to back up, causing a leak.
- 3) If the drain hose is too long, water may not drain completely, which can lead to stagnant water and mildew building up inside the hose.
- 4) Before moving the dehumidifier, make sure the condensed water inside is completely drained to avoid water leakage.

When it is necessary to connect an external water pump, one end of the drain pipe is connected to the water outlet, and the other end is connected to the water inlet of the water pump.

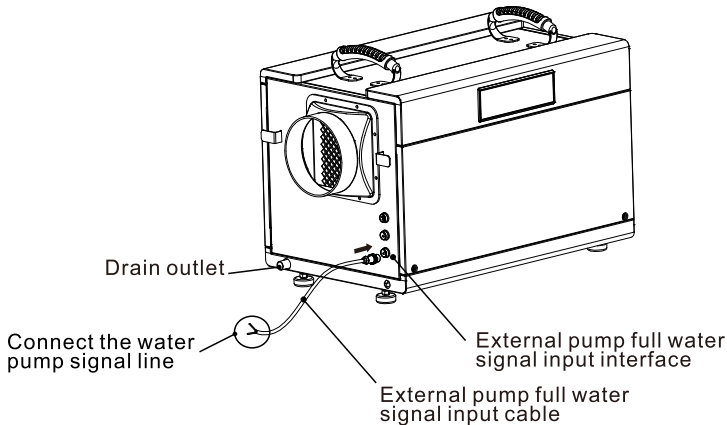

Note: The reserved external water pump signal input port cannot be connected to the power supply, so as not to cause the main board of the product to burn out, The power of the machine must be unplugged when connecting.

Picture 1: Example of improper installation.

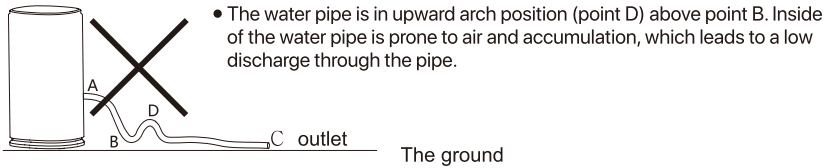

Picture 2: Example of improper installation.

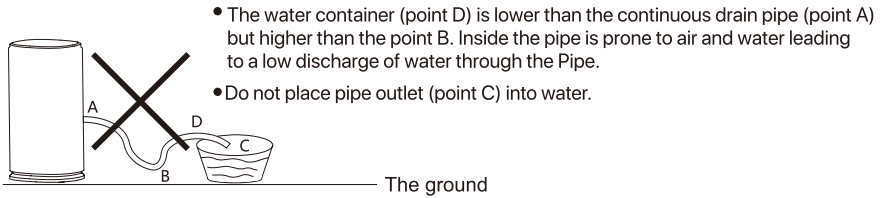

Picture 3: Example of proper installation.

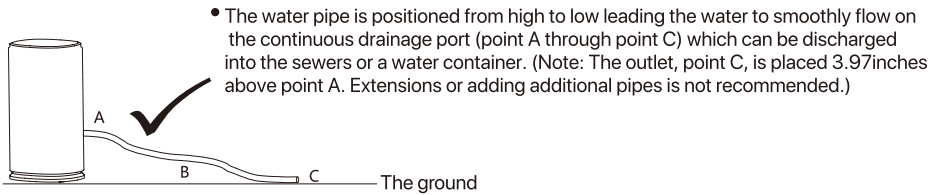

The picture is for reference only.

Maintenance

Unplug the power cord before maintaining and cleaning the dehumidifier. Use a soft damp cloth to clean the body of the dehumidifier. Don't use detergents, scrubbing wires, chemically treated dusting cloths, gasoline, thinner, or other solvents to clean and wipe the machine.

Steps to remove the filter:

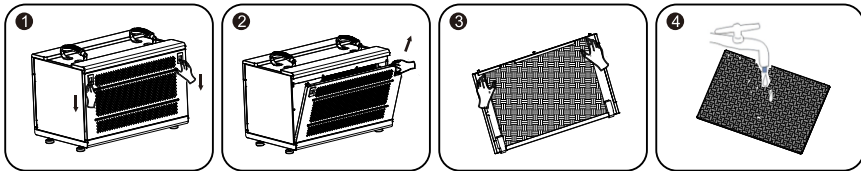

Clean the filter:

There is a washable filter behind the dehumidifier to filter airborne dirt. It is recommended to check the filter regularly and clean it at least once a month.







- 1) Use a vacuum cleaner or something to gently remove the dirt on the filter;
- 2) If the filter is particularly dirty, rinse it with warm water and mild detergent, and dry it thoroughly; do not expose the filter to direct sunlight or use other exothermic products to dry the filter, which will deform the filter and its frame;
- 3) Put the dried filter back into the dehumidifier; If the dehumidifier fails, please follow the "Troubleshooting" in the manual before contacting LUBAIR support. Do not repair or disassemble the dehumidifier by yourself.

Improper maintenance may endanger the safety of users.

Note: Don't operate the dehumidifier without a filter because dirt and lint maybe clog it.

Parts List & Schematic diagram of flange installation

1. Parts list:

Picture	Name	Quantity
	Air outlet bar	1PCS
	External pump full water signal input cable	1PCS
	Rs485 communication cable	1PCS
	Drain pipe	1PCS
	Drainpipes Fastening Rings	1PCS
	M4 screw	6PCS

2.Schematic diagram of flange installation

Note:The following operations need to be performed with the power off.

- ① Unscrew the two screws below the access door with a Phillips screwdriver.

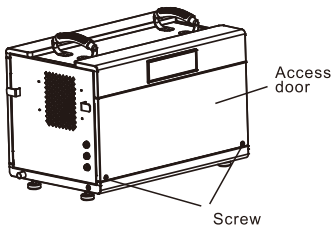

- ② Remove the access door. Take out the air outlet bar;

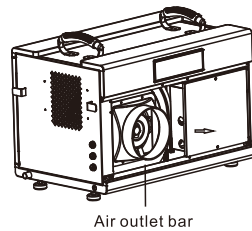

- ③ Install the control panel hole cover, and use a screwdriver to tighten the two screws below; install the access door.

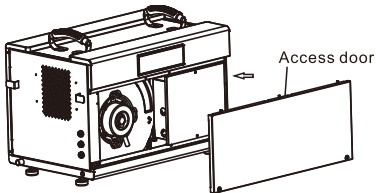

- ④ Use 4 M4 screws to fix the air outlet bar to the reserved holes; use 4 gaskets. installation is complete.

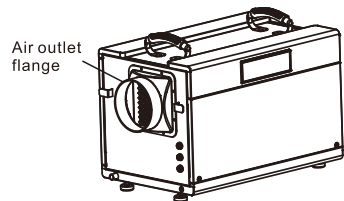

Troubleshooting

Before seeking support from the service team, you can check the following troubleshooting tips:

Fault	Cause	Solution
Dehumidifier not working	<ol style="list-style-type: none"> 1. The fuse is blown 2. Machine failure prompt 	<ol style="list-style-type: none"> 1. Replace the fuse; 2. Query the fault code and request the manufacturer's technical support;
Dehumidifying effect is not obvious	<ol style="list-style-type: none"> 1. Air filter fouling; 2. There are obstacles in the air inlet and outlet of the dehumidifier; 3. The space is not sealed; 4. Refrigerant leakage; 	<ol style="list-style-type: none"> 1. Clean the filter; 2. Remove obstacles; 3. Close the doors and windows, the dehumidification effect of the confined space is more obvious; 4. Contact the agent or manufacturer for maintenance;
Water leakage	<ol style="list-style-type: none"> 1. Machine tilt; 2. The outlet pipe is Blocked; 	<ol style="list-style-type: none"> 1. Adjust the machine and place it horizontally; 2. Remove the access door to remove the foreign matter blocked in the pipe;
Abnormal noise	<ol style="list-style-type: none"> 1. The machine is not placed smoothly; 2. Is the filter blocked; 	<ol style="list-style-type: none"> 1. Relocate the machine to a stable place; 2. Clean the filter;
Humidity always shows "10" (when there is a big difference from the actual humidity)	Humidity sensor failure	<ol style="list-style-type: none"> 1. When the "10" fault phenomenon is always displayed, the humidity is set to 10%RH, and the machine can still continue to run and be used normally; 2. Repair and replace the humidity sensor;
Humidity always shows "99"(when there is a big difference from the actual humidity)	<ol style="list-style-type: none"> 1. The surface of the humidity sensor is condensed or wetted with water; 2. Humidity sensor failure 	<ol style="list-style-type: none"> 1. When the "99" fault phenomenon is displayed all the time, the machine can still continue to dehumidify and operate normally; 2. After the machine has been running for a period of time, when the moisture on the surface of the humidity sensor dissipates, it can automatically remove the fault and resume normal operation; 3. Repair and replace the humidity sensor;

1. When the above fault cannot be eliminated and it is confirmed that repair is required, please contact the LUBAIR support, please do not disassemble the machine for repair without authorization.
2. When the dehumidifier is running or stopped, it is normal to hear the sound of refrigerant circulating.
3. It is normal for hot air to be discharged from the air outlet.

Safety Precautions



1. When using, do not place the dehumidifier on soft, uneven ground to avoid vibration or movement.

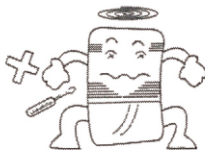

2. Do not use thin rods or hard objects to insert into the fuselage to avoid malfunction or danger.

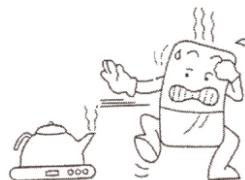

3. When using, please keep the dehumidifier away from heat sources such as heaters and electric kettles to save electricity.



4. When using, please close the doors and windows to achieve the best dehumidification effect.



5. Do not place items before and after the dehumidifier. If the ventilation is blocked, the dehumidification effect will be affected.



6. In case of power failure or long-term non-use, please unplug the power cord.



7. When cleaning the dehumidifier, gently wipe it with a damp cloth, do not directly spray water to clean it.

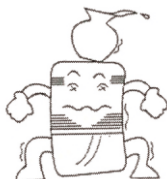

8. Do not place any objects on the dehumidifier.



9. Please clean the filter every two weeks (do not use hot water above 104°F/40°C, alcohol, gasoline, or toluene).



10. During continuous drainage, the drainage pipe must be placed horizontally or downwards, and must not be uneven or entangled.



11. After the filter is cleaned, please do not place it in direct sunlight to dry it to avoid deformation.



12. Before moving or carrying the dehumidifier, please pour out the accumulated water in the water tank.

Service

LUBAIR offers a limited 1-year free warranty on this DY145 dehumidifier, with original proof of purchase (typically you may be only requested to offer the order number or other information to prove a genuine purchase, instead of an invoice) and where a defect has arisen, wholly or substantially, as a result of faulty manufacture, parts or workmanship during the warranty period.

During the warranty period, for the damaged part, we will provide a replacement part if it can be restored to normal use by replacing parts.

The warranty does not apply where damage is caused by other factors, including without limitation:

- Normal wear and tear;
- Abuse, mishandling, accident, or failure to follow operating instructions;
- Exposure to liquid or infiltration of foreign particles;
- Servicing or modifications of the product other than by LUBAIR.

We will try our best to inspect the dehumidifier through photos or videos to troubleshoot and ensure that we can better solve the problem for you. These are our general terms for warranty service, but we always urge our customers to reach out to us with any issue, regardless of warranty terms.

Warranty and Service

If you have an issue with an LUBAIR product, please contact us at LubairServices@outlook.com, and we will do our best to resolve it for you.



Support Hours

24 Hours available

*Please have your order number before contacting customer support.

Product Certification

The product is approved to leave the factory after passing the inspection.
Production date: see the nameplate or barcode of the fuselage





LUBAIR