



GAZEBO Penguin inc.

4660 HICKMORE ST,
MONTREAL, QUEBEC
H4T 1K2
TEL: 1-514-276-3485, 1-800-737-7174
Email: customerservice@gazebopenguin.com

**PLEASE READ
IN ITS ENTIRETY
BEFORE
INSTALLATION**

**PLEASE READ
IN ITS ENTIRETY
BEFORE
INSTALLATION**

41212-12 / 41212-32

12 X 12 SOLARIUM

ASSEMBLY INSTRUCTIONS

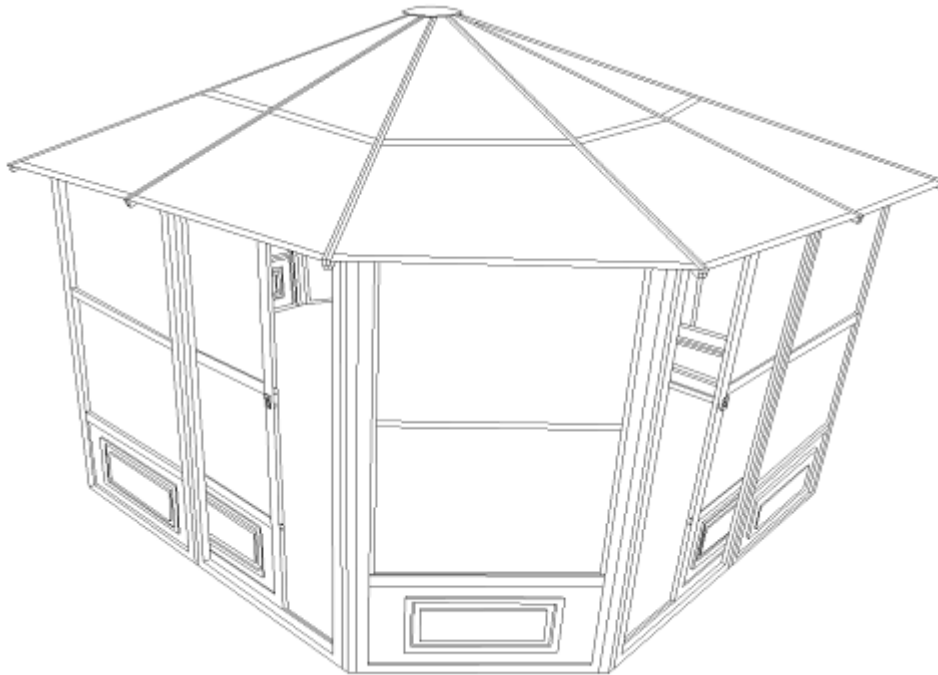

**DO NOT DESTROY THE BOXES UNTIL COMPLETELY ASSEMBLED
PLEASE VERIFY THE CONTENT OF EACH BOX AGAINST THE LIST OF PARTS**

Two or more adults required for assembly

Base Dimensions 12' ½"x12' ½", Largest Dimensions 13'6"x13'6" (see pg.14)
Overall Height 110"

Before you assemble the Solarium

- Please don't destroy boxes until completely assembled.
- Please verify the content of each box against the list of parts.
- It is important that this solarium be installed on a solid base with the provided screws. Otherwise, please ensure that you use anchors sufficient for your surface.
- The solarium should not be installed adjacent to trees or a sloped roof. Snow and ice may slide onto the solarium and cause it to collapse.

Tools needed:

- Step ladder
- #2 Phillips screwdriver (not supplied)
- Rubber mallet

Based on the location, decide where you would like to position the two(2) door panels which can slide open to the left or to the right, your choice.

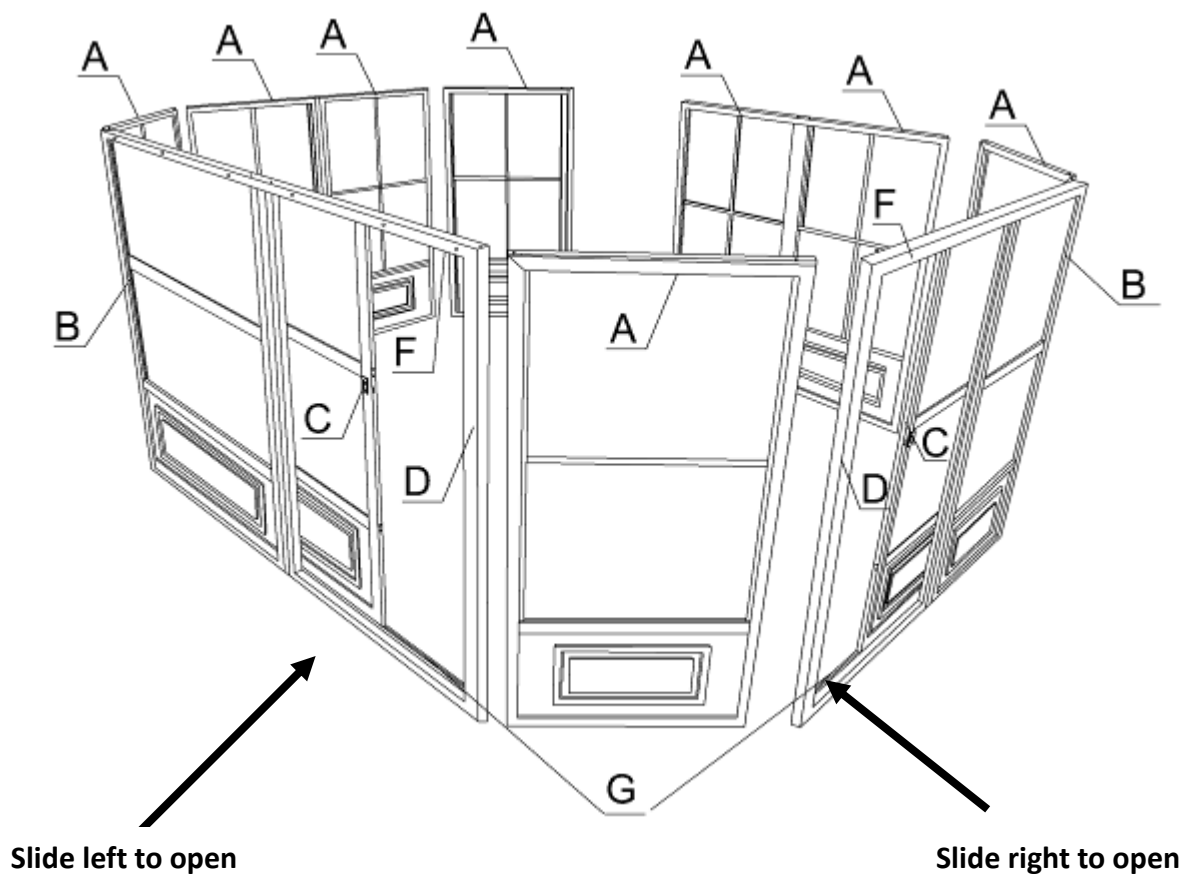

12x12 Solarium Assembly Instructions

Step 1:

Before starting to assemble, please decide where you would like to position the door panels.

1. Stand up the two panels (A), using two connecting pieces (E) affix the panels (A) together.
2. Stand up a frame meant to be next to the door (B) and a door frame (D), you can chose to place the door frame on the left side or on the right side, and then use two connecting pieces (E) to affix the panel and door frame.
3. When assembling angled panels (A, D), you should put the two panels at 135 degree angle then use the angled connecting pieces (I) and (J) to affix the panels together.

(1)

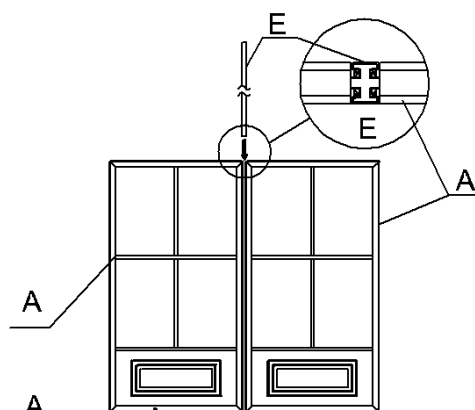

(2)

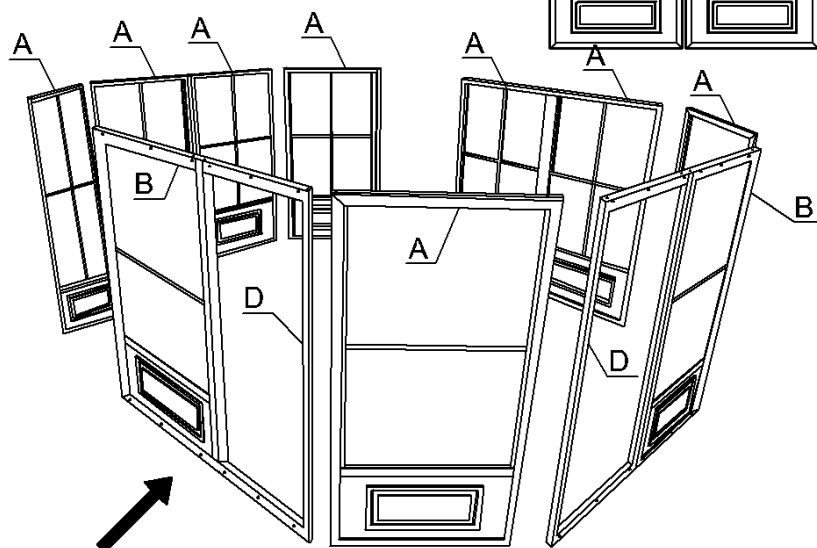

(3)

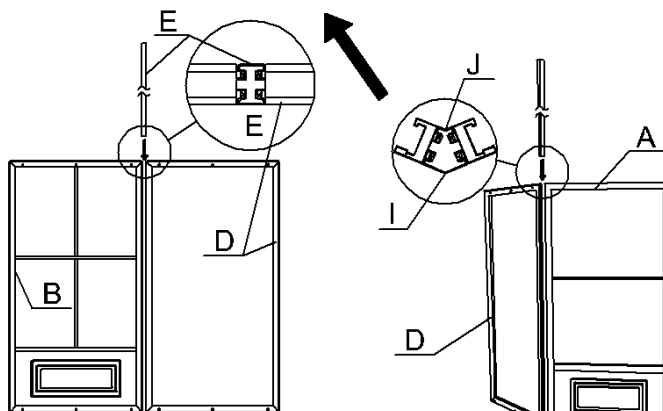

Step 2:

1. Slide top door rail (F) into wheels of sliding door (C).
2. Slide lower door rail (G) into the plastic guide of the sliding door (C).
3. Use bolt (Bb) to affix the plastic stoppers (H) one on each end of top door rail (F).
4. Use screw (Oo) to affix upper door rail end caps (Nn) one on each end of top door rail (F).

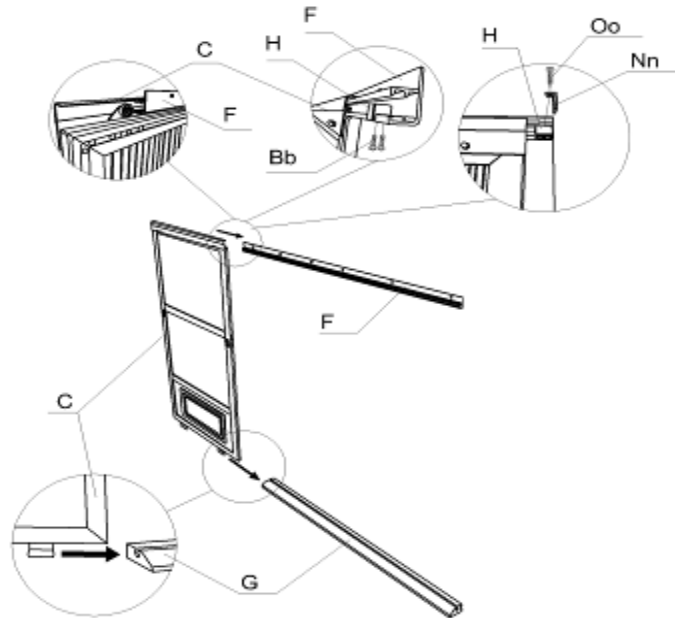

Step 3: Please note the sliding door should be installed from the inside of the solarium.

1. Place a bolt (Ww) with washer through the top door rail (F) and door frame, and place a female bolt (Cc-2) from the other side. Once all are inserted, tighten them all securely.
2. Secure the bottom door rail (G), using bolts (Cc) and washers.
3. Paying careful attention to whether it is the left (Dd-L) or right (Dd-R) latch, use bolt (Bb) to affix the door latch onto the Frame.

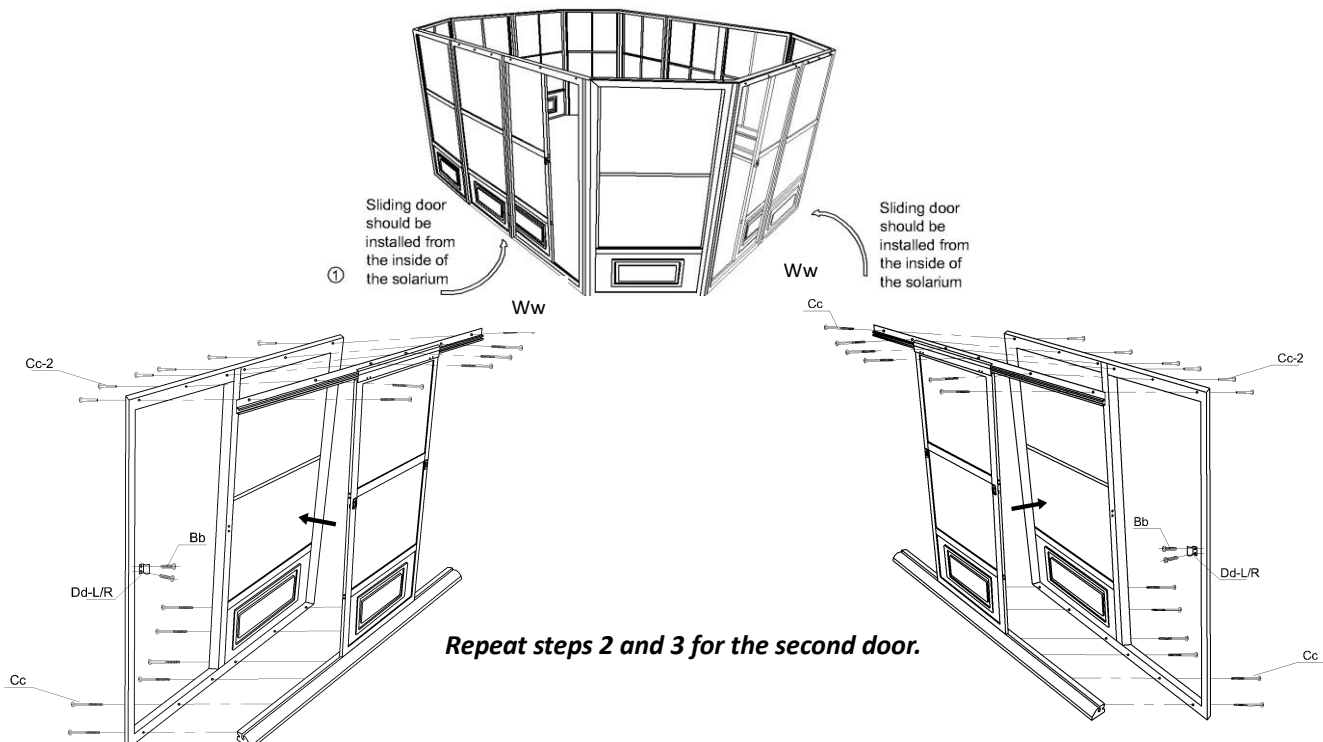

Repeat steps 2 and 3 for the second door.

Step 4:

1. Attach roof rafters (L) to the central hub (N) using bolt (Bb). (Caution: hub may be heavy, use support if needed).
2. Use screw (Z) to affix the rafters (L) onto the top of panels going through the metal piece attached to the rafter (L). Rafters must be affixed where panels connect to each other.

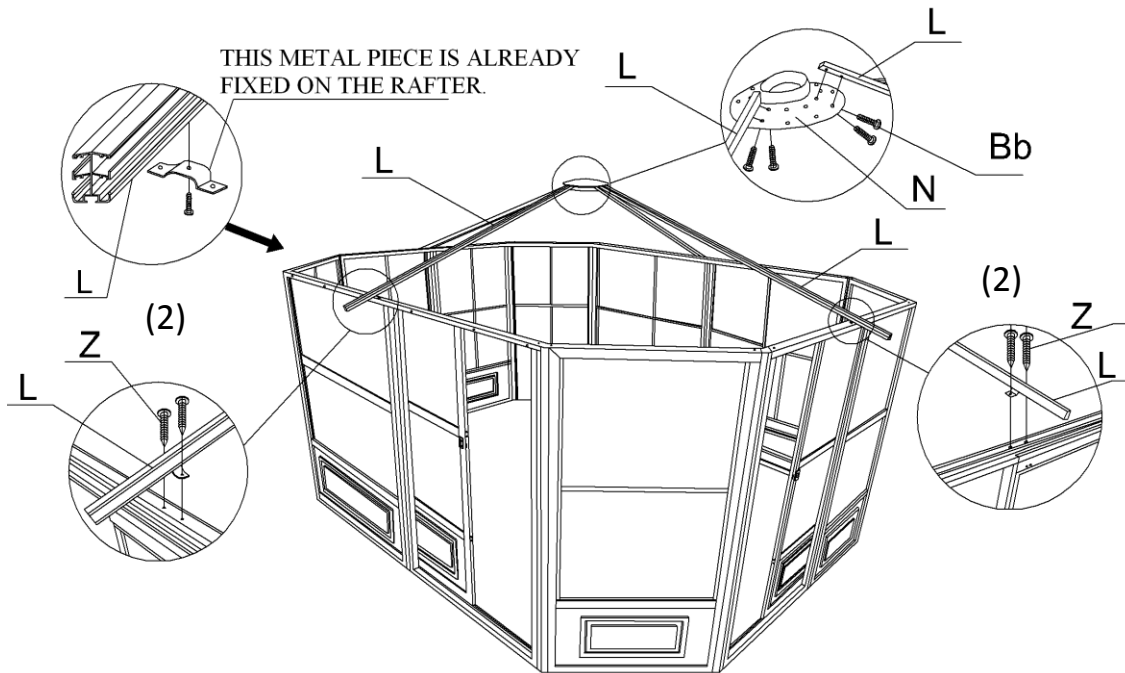

Step 5:

Use the same method to assemble roof rafters (K) for the angled panels. The rafters (K) should be affixed to the mounting bracket using the hole that will be furthest away from the corner of the unit.

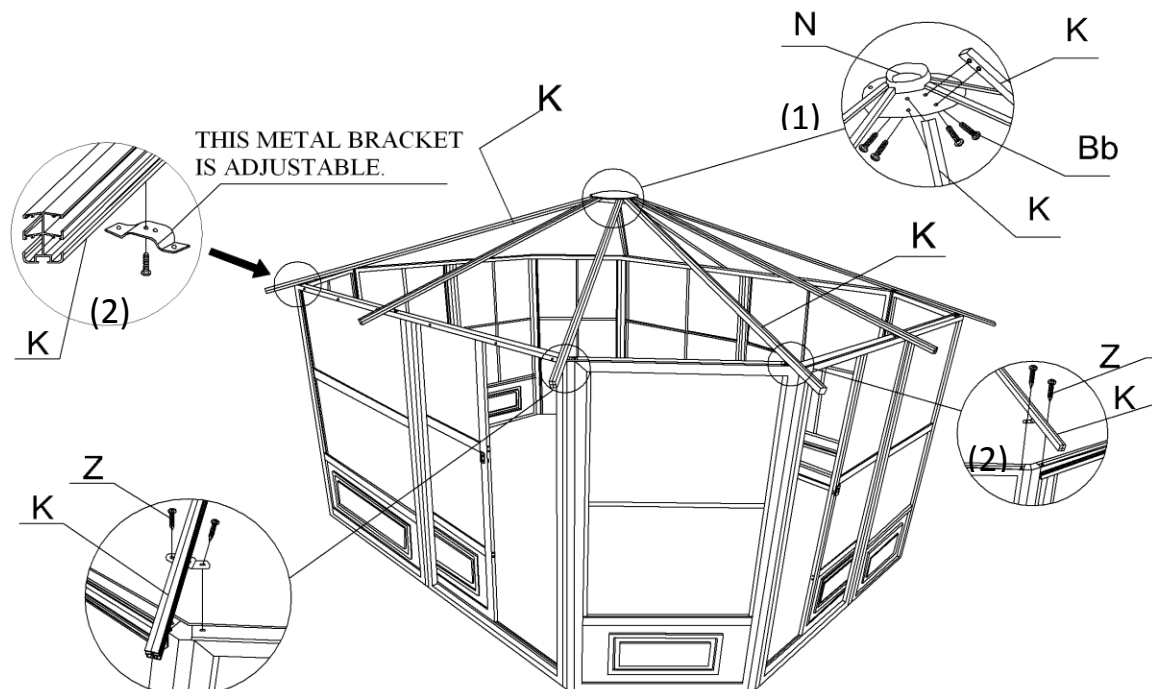

Note: Do not tighten the bolts right away as you may have to adjust the angle when inserting the PC roof panels.

Step 6:

Use nut (Hh) and washer (Gg) to affix the top cap (M) to the central hub (N).

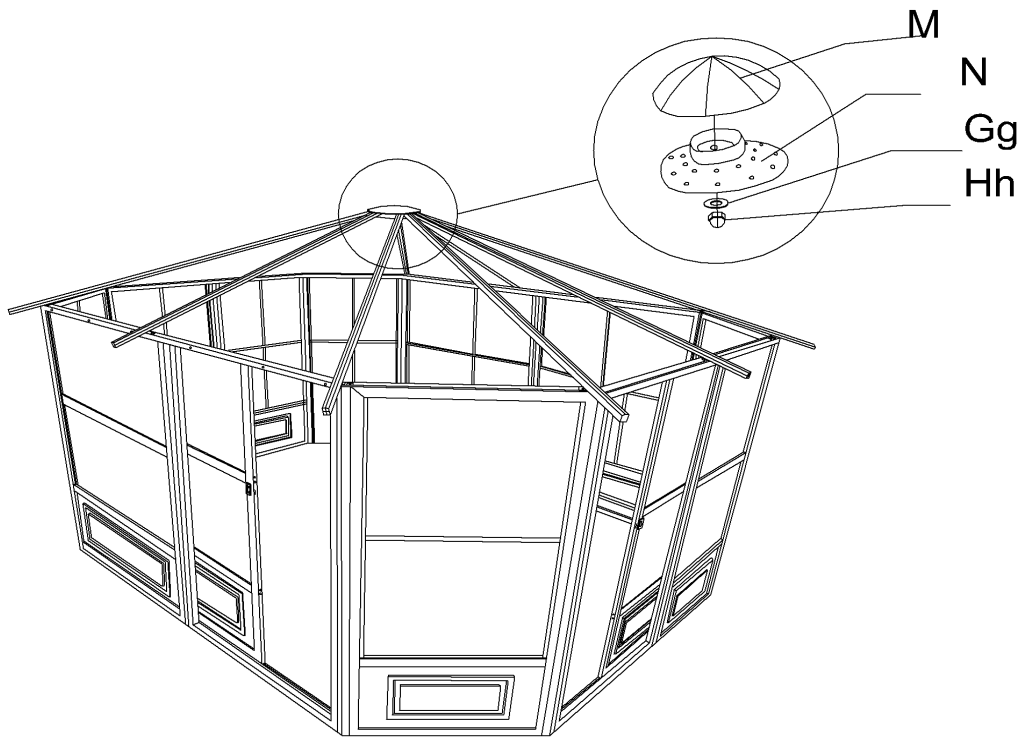

Step 7:

First remove the protective layer from the PC roof panels, then insert them (Y, Aa, LI) into the roof rafters according to the below drawing instructions.

Note: the side that had the protective layer should face down.

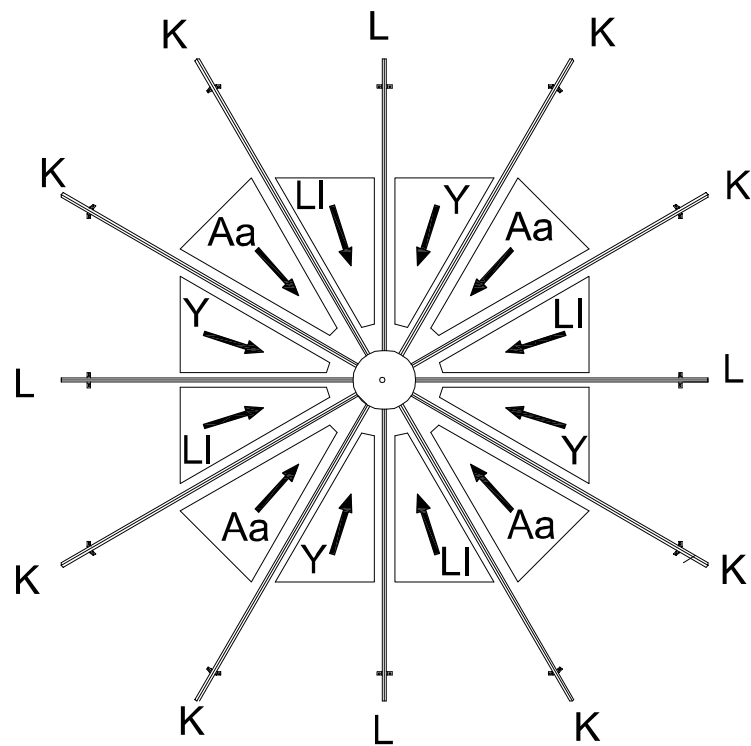

TOP VIEW

Step 8:

After inserting the PC roof panels, insert the aluminum middle roof joints (O, P, Q) into the roof rafters. The below drawing view is from the inside of the solarium, looking up.

Notes:

- The drain holes on the aluminum middle roof joints (O, P, Q) should be at the bottom.
 - To adjust the middle joints to line up : once all polycarbonate roof panels are in place, use a small piece of wood and hammer, then tap down on the middle of the joint bringing it down and holding at the same time the joint and top polycarbonate.
- Do not tap too hard.

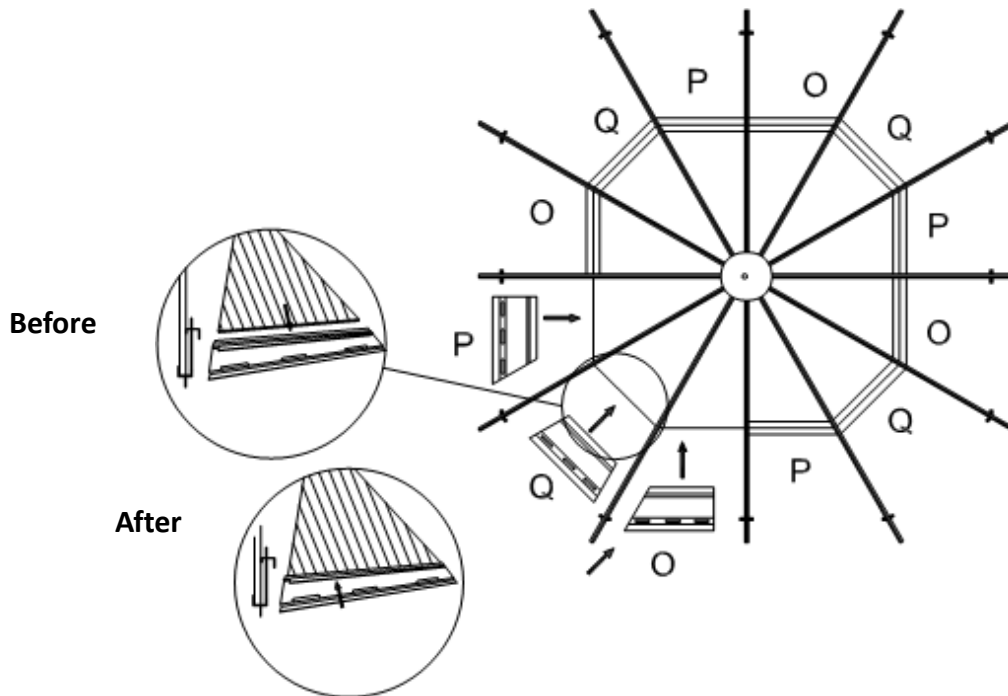

Step 9:

Insert the outer PC roof panels (Jj, Kk, Mm) according to below drawing. They should overlap about two inches under the upper PC roof panels and into the aluminum middle roof joints.

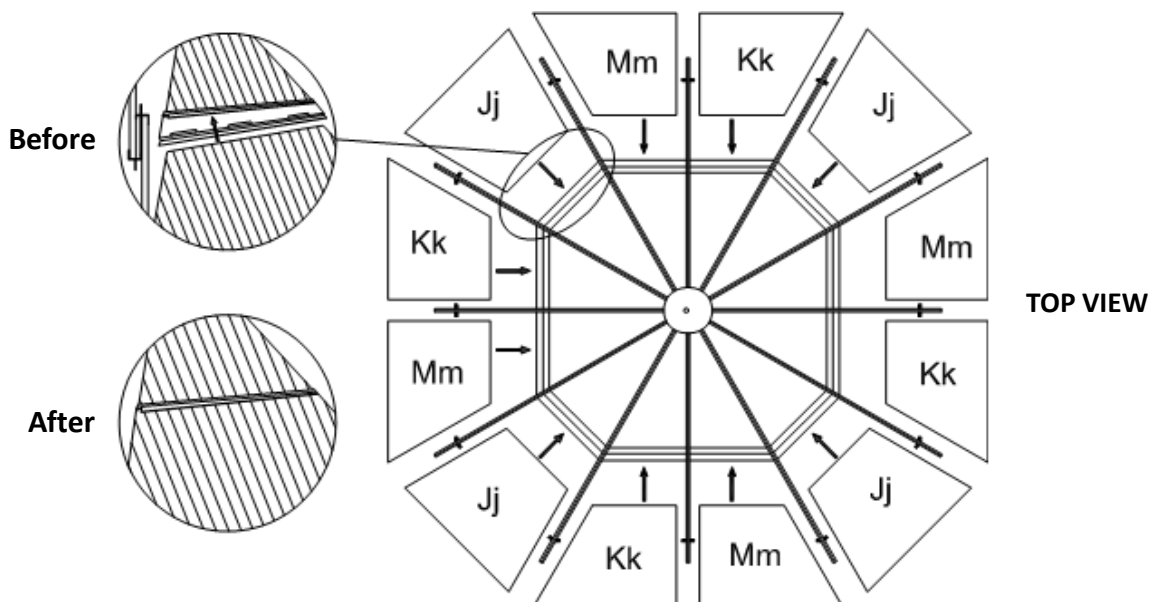

Step 10:

Once the PC roof is complete, use aluminum edging (S, U, W) to surround the edges of the PC roof using bolts (Bb) to fasten the rafter cap (R) and the edging, tighten securely.

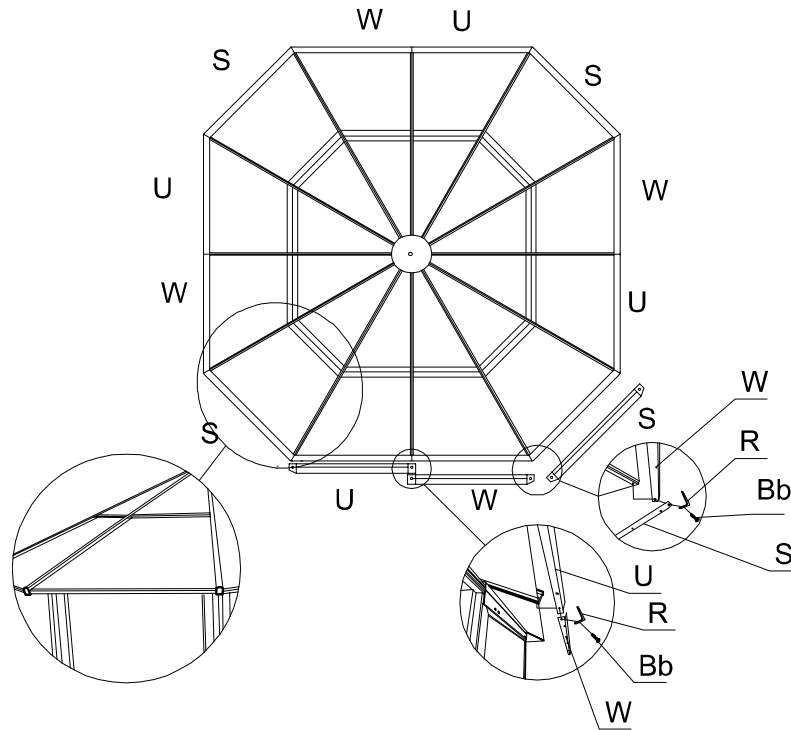

Step 11:

Use the cross bars (T, V, X) to affix to the roof using bolts (Ff).

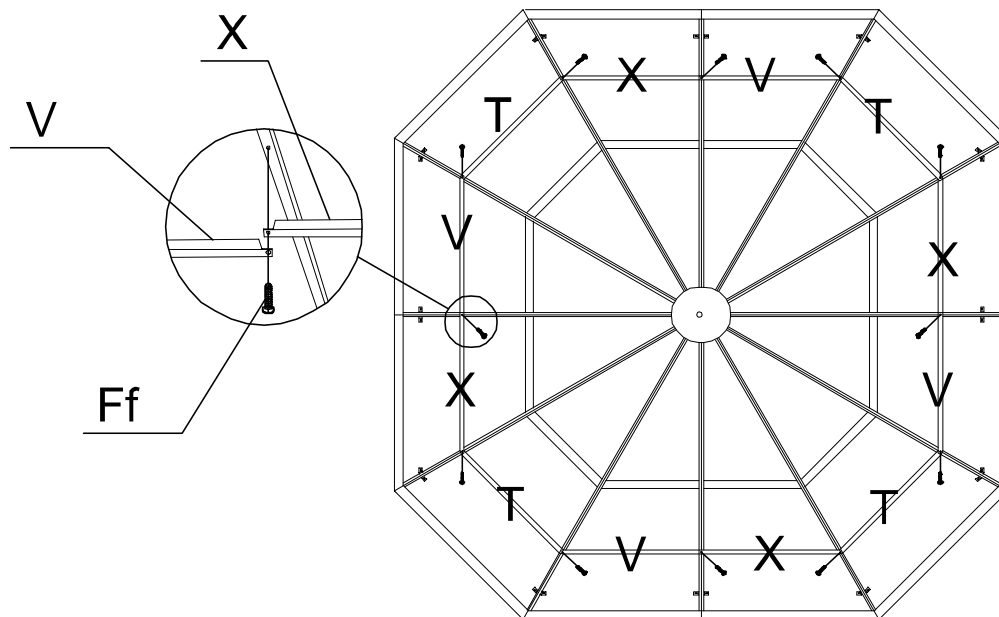

Step 12:

Inside each of the panels (A, B), push two plastic plugs (li) into the ground, and then screw down the panels using two screws (Ee) for each panel.

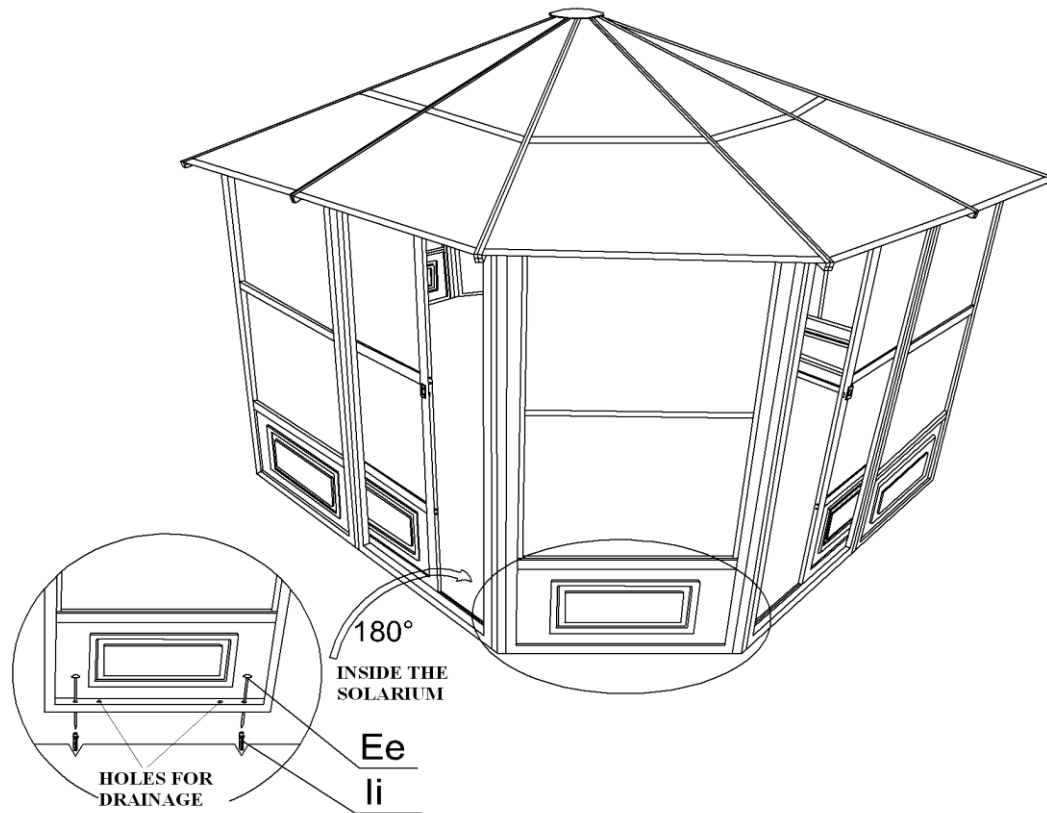





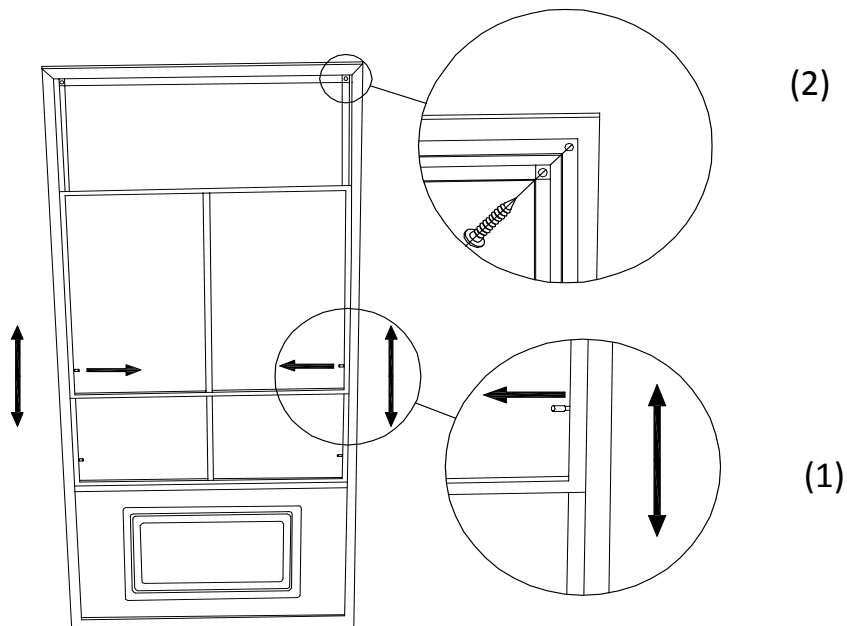

Special notes:

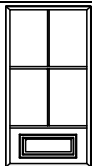
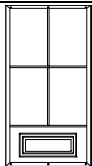

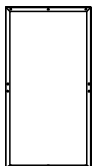

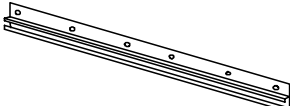
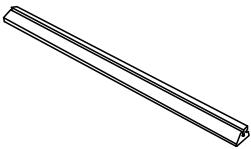
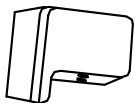
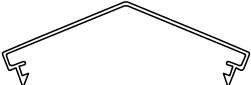
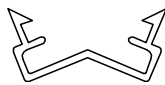
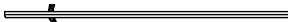
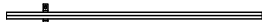
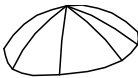
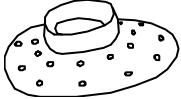

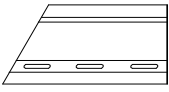
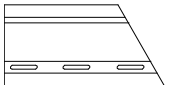
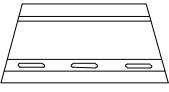
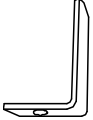
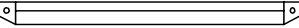
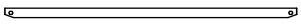
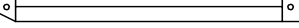

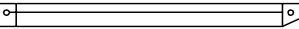
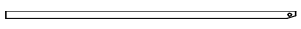
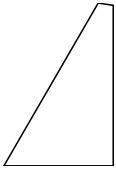
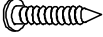
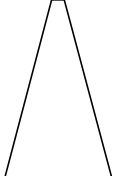
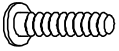
1. To remove windows (08-219), pull 1 pin out of the lock position and push the frame to the end of the track, then ease the window out of the tracks one side at a time.
2. To remove screening panel, first remove windows, then unscrew the 2 screws at the top corners of the screen frame.

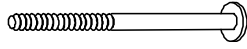
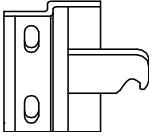
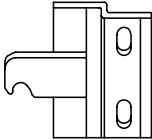
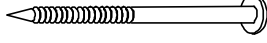
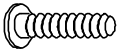



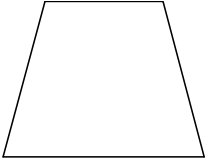
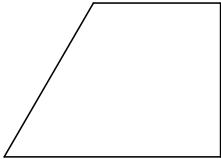
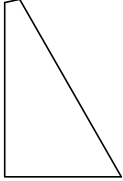
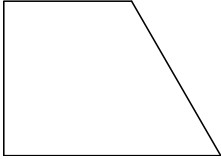

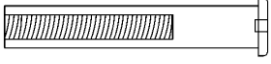



41212-12 SAND PARTS LIST

DESCRIPTION	PACKED IN BOX	QTY	DRAWING	DESCRIPTION	PACKED IN BOX	QTY	DRAWING
08-129-12 REGULAR FRAME A	3	6		08-130-12 FRAME NEXT TO DOOR B	2	2	
	2	2					
08-131-12 SLIDING DOOR C	2	2		08-132-12 SLIDING DOOR FRAME D	2	2	
08-133-12 CONNECTING PIECE E Length 200.6 cm	4	8		08-136-12 TOP DOOR RAIL F Length 206 cm	4	2	
08-137-12 BOTTOM DOOR RAIL G Length 206 cm	4	2		08-138-12 PLASTIC STOPPER H	5	4	
08-139-12 135° ANGLED OUTSIDE CONNECTOR I Length 200.6 cm	4	8		08-140-12 135° ANGLED INSIDE CONNECTOR J Length 200.6 cm	4	8	
08-141-12 ROOF RAFTER K Length 239.7 cm	4	8		08-142-12 ROOF RAFTER L Length 211 cm	4	4	
08-143-12 TOP CAP M	5	1		08-144-12 CENTRAL HUB N	5	1	

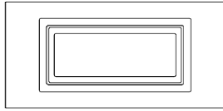

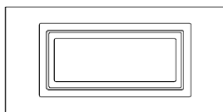

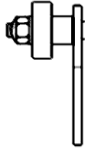

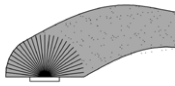
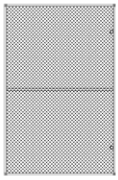
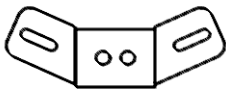
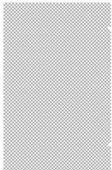
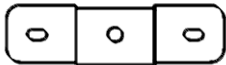

DESCRIPTION	PACKED IN BOX	QTY	DRAWING	DESCRIPTION	PACKED IN BOX	QTY	DRAWING
08-145-12 MIDDLE ROOF JOINT O	5	4		08-146-12 MIDDLE ROOF JOINT P	5	4	
08-147-12 MIDDLE ROOF JOINT Q	5	4		08-148-12 ROOF RAFTER CAP R	5	12	
08-149-12 EDGING S Length 120.6 cm	5	4		08-150-12 ROOF CROSS BAR T Length 94.5 cm	5	4	
08-151-12 EDGING U Length 120.6 cm	5	4		08-152-12 ROOF CROSS BAR V Length 94.4 cm	5	4	
08-153-12 EDGING W Length 120.6 cm	5	4		08-154-12 ROOF CROSS BAR X Length 94.4 cm	5	4	
08-155 (24 1/4" x42 1/4") TOP ROOF LEFT PANEL Y	1	4		08-156-12 SCREW Z	5	24	 (M4*16mm)
08-157 (24 1/2" x46 1/2") TOP ROOF CORNER PANEL Aa	1	4		08-158-12 BOLT Bb	5	48	 (M6*16mm)

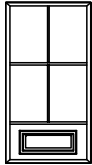
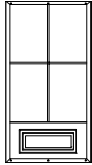
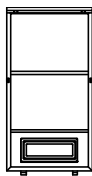
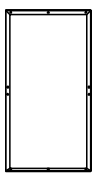

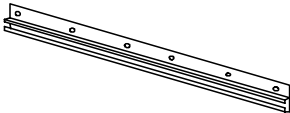
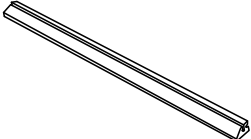
DESCRIPTION	PACKED IN BOX	QTY	DRAWING	DESCRIPTION	PACKED IN BOX	QTY	DRAWING
08-161-12 BOLT Cc	5	12	 (M6*70mm)	08-165-12 RIGHT DOOR LATCH Dd-R	5	2	
08-169-12 LEFT DOOR LATCH Dd-L	5	2		08-167-12 SCREW Ee	5	20	 (M6*100mm)
08-168-12 BOLT Ff	5	12	 (M6*12mm)	08-187 WASHER Gg	5	39	
08-189-12 ACORN NUT Hh	5	1		08-193 PLASTIC PLUG Ii	5	20	
08-195 (47" X47 1/2") BOTTOM ROOF CORNER PANEL Jj	1	4		08-196 (46 1/2"x43") BOTTOM ROOF LEFT PANEL Kk	1	4	
08-197 (24 1/4" X42 1/4") TOP ROOF RIGHT PANEL Ll	1	4		08-198 (46 1/2"x43") BOTTOM ROOF RIGHT PANEL Mm	1	4	
08-134-12 UPPER DOOR RAIL END CAP Nn	5	4		08-135-12 SCREW Oo	5	4	 (M4*12mm)
12-037-12 FEMALE BOLT Cc-2	5	12	 M5*60mm	12-047-12 BOLT Ww	5	12	 (M5*15mm)

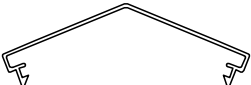
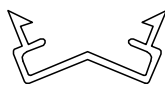





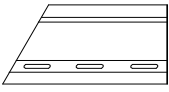
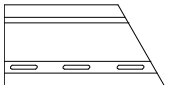
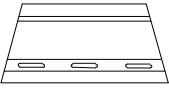
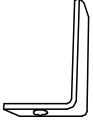
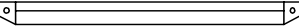
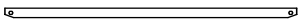
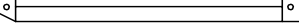

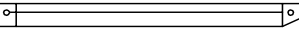
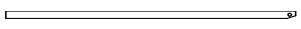
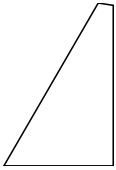
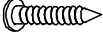
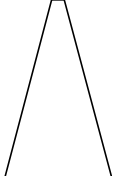
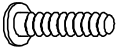
AVAILABLE REPLACEMENT PARTS

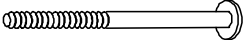
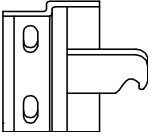
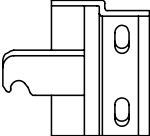
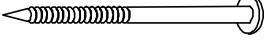
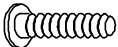
DESCRIPTION	DRAWING	DESCRIPTION	DRAWING
08-219-12 PVC WINDOW (in frame)		85-417-S ROUND SPLINE FOR SCREENING	
10-493 PVC WINDOW (replacement material only)		11-572-12 BOTTOM PLASTIC PANEL (for wall panels)	
85-417-P ROUND SPLINE FOR PVC WINDOW		11-822-12 BOTTOM PLASTIC PANEL (for doors)	
15-123-12 PIN FOR PVC WINDOW		15-097-12 DOOR WHEEL ASSEMBLY	
13-033 PC WINDOW (for sliding door)		10-458 REPLACEMENT WEATHERSTRIP	
12-046-12 MOSQUITO SCREEN (in frame)		15-124-12 MOUNTING BRACKET FOR RAFTER (K)	
85-014 REPLACEMENT SCREENING (no frame)		15-125-12 MOUNTING BRACKET FOR RAFTER (L)	



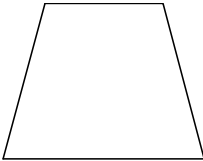
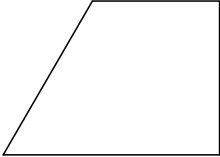
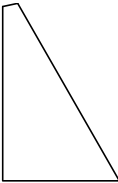
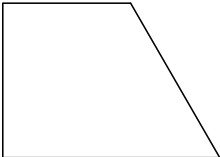

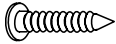
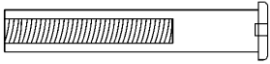



41212-32 SLATE PARTS LIST

DESCRIPTION	PACKED IN BOX	QTY	DRAWING	DESCRIPTION	PACKED IN BOX	QTY	DRAWING
08-129-32 REGULAR FRAME A	3	6		08-130-32 FRAME NEXT TO DOOR B	2	2	
	2	2					
08-131-32 SLIDING DOOR C	2	2		08-132-32 SLIDING DOOR FRAME D	2	2	
08-133-32 CONNECTING PIECE E Length 200.6 cm	4	8		08-136-32 TOP DOOR RAIL F Length 206 cm	4	2	
08-137-32 BOTTOM DOOR RAIL G Length 206 cm	4	2		08-138-32 PLASTIC STOPPER H	5	4	
08-139-32 135° ANGLED OUTSIDE CONNECTOR I Length 200.6 cm	4	8		08-140-32 135° ANGLED INSIDE CONNECTOR J Length 200.6 cm	4	8	
08-141-32 ROOF RAFTER K Length 239.7 cm	4	8		08-142-32 ROOF RAFTER L Length 211 cm	4	4	
08-143-32 TOP CAP M	5	1		08-144-32 CENTRAL HUB N	5	1	

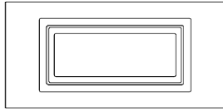
DESCRIPTION	PACKED IN BOX	QTY	DRAWING	DESCRIPTION	PACKED IN BOX	QTY	DRAWING
08-145-32 MIDDLE ROOF JOINT O	5	4		08-146-32 MIDDLE ROOF JOINT P	5	4	
08-147-32 MIDDLE ROOF JOINT Q	5	4		08-148-32 ROOF RAFTER CAP R	5	12	
08-149-32 EDGING S Length 120.6 cm	5	4		08-150-32 ROOF CROSS BAR T Length 94.5 cm	5	4	
08-151-32 EDGING U Length 120.6 cm	5	4		08-152-32 ROOF CROSS BAR V Length 94.4 cm	5	4	
08-153-32 EDGING W Length 120.6 cm	5	4		08-154-32 ROOF CROSS BAR X Length 94.4 cm	5	4	
08-155 (24 1/4" x42 1/4") TOP ROOF LEFT PANEL Y	1	4		08-156-32 SCREW Z	5	24	 (M4*16mm)
08-157 (24 1/2" x46 1/2") TOP ROOF CORNER PANEL Aa	1	4		08-158-32 BOLT Bb	5	48	 (M6*16mm)

DESCRIPTION	PACKED IN BOX	QTY	DRAWING	DESCRIPTION	PACKED IN BOX	QTY	DRAWING
08-161-32 BOLT Cc	5	12	 (M6*70mm)	08-165-32 RIGHT DOOR LATCH Dd-R	5	2	
08-169-32 LEFT DOOR LATCH Dd-L	5	2		08-167-32 SCREW Ee	5	20	 (M6*100mm)
08-168-32 BOLT Ff	5	12	 (M6*12mm)	08-187 WASHER Gg	5	39	
08-189-32 ACORN NUT Hh	5	1		08-193 PLASTIC PLUG Ii	5	20	
08-195 (47" X47 1/2") BOTTOM ROOF CORNER PANEL Jj	1	4		08-196 (46 1/2"x43") BOTTOM ROOF LEFT PANEL Kk	1	4	
08-197 (24 1/4" X42 1/4") TOP ROOF RIGHT PANEL Ll	1	4		08-198 (46 1/2"x43") BOTTOM ROOF RIGHT PANEL Mm	1	4	
08-134-32 UPPER DOOR RAIL END CAP Nn	5	4		08-135-32 SCREW Oo	5	4	 (M4*12mm)
12-037-32 FEMALE BOLT Cc-2	5	12	 M5*60mm	12-047-32 BOLT Ww	5	12	 (M5*15mm)

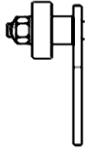
AVAILABLE REPLACEMENT PARTS

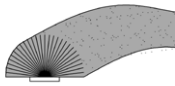
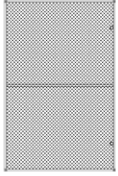
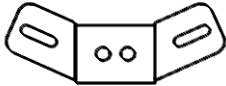
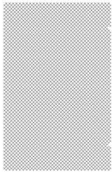
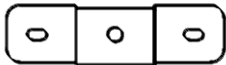
DESCRIPTION	DRAWING	DESCRIPTION	DRAWING
08-219-32 PVC WINDOW (in frame)		85-417-S ROUND SPLINE FOR SCREENING	
10-493 PVC WINDOW (replacement material only)		11-572-32 BOTTOM PLASTIC PANEL (for wall panels)	
85-417-P ROUND SPLINE FOR PVC WINDOW		11-822-32 BOTTOM PLASTIC PANEL (for doors)	
15-123-32 PIN FOR PVC WINDOW		15-097-32 DOOR WHEEL ASSEMBLY	
13-033 PC WINDOW (for sliding door)		10-458 REPLACEMENT WEATHERSTRIP	
12-046-32 MOSQUITO SCREEN (in frame)		15-124-32 MOUNTING BRACKET FOR RAFTER (K)	
85-014 REPLACEMENT SCREENING (no frame)		15-125-32 MOUNTING BRACKET FOR RAFTER (L)	

MAINTENANCE NOTES

1. In case of a defective or damaged part, or for any other questions concerning the product, please contact the manufacturer directly.
2. Please have the parts list and part numbers on hand when ordering or requesting replacement parts.
3. The product should not be installed adjacent to trees or a sloped roof. Snow and ice may slide onto the roof and cause it to collapse.
4. While the product is designed for 4 seasons use, the roof must be kept free of accumulation of snow.



ONE YEAR LIMITED WARRANTY

This product has been designed and manufactured to meet the highest standards of quality and durability. Subject to the Conditions for Exercising the Warranty and the Limitations on the Warranty set forth below, it is warranted to be free of material and manufacturing defects for a period of **one year** from the date of purchase. Should the product become damaged, or the warranty period has expired, please contact Gazebo Penguin Customer Service Department for a complete schedule of replacement parts and prices.

CONDITIONS FOR EXERCISING THE WARRANTY

The warranty only applies to the original purchaser with the bill.

In order to properly exercise your warranty, please comply with the following:

Carefully inspect the contents of the carton for missing or damaged components. Should you discover damaged or missing parts, **do not return the product to the place of purchase**, but contact Gazebo Penguin Customer Service Department at the numbers listed below:

Montreal: (514) 276-3485

Elsewhere: 1-800-737-7174

You can also find a claim form to fill out online:

<http://www.abrispenguin.com/forms.html>

NOTE: Damages/missing parts must be reported within 30 days of delivery.

LIMITATIONS ON THE WARRANTY

1. The product is not warranted against damages due to vandalism, abuse, falling or thrown objects, or accumulation of snow.
2. The product is not warranted against damages due to extreme weather conditions, such as thunderstorms, hail, strong wind or snow storms, or any other acts of God.
3. The product is only warranted in the event it is installed in accordance with the Gazebo Penguin's written instructions enclosed with the product.
4. The product is not warranted in the event it has been improperly anchored.
5. We reserve the right to replace or repair any defective product or parts at our discretion.