

DENBIG PORTABLE AIR CONDITIONER Instruction Manuel

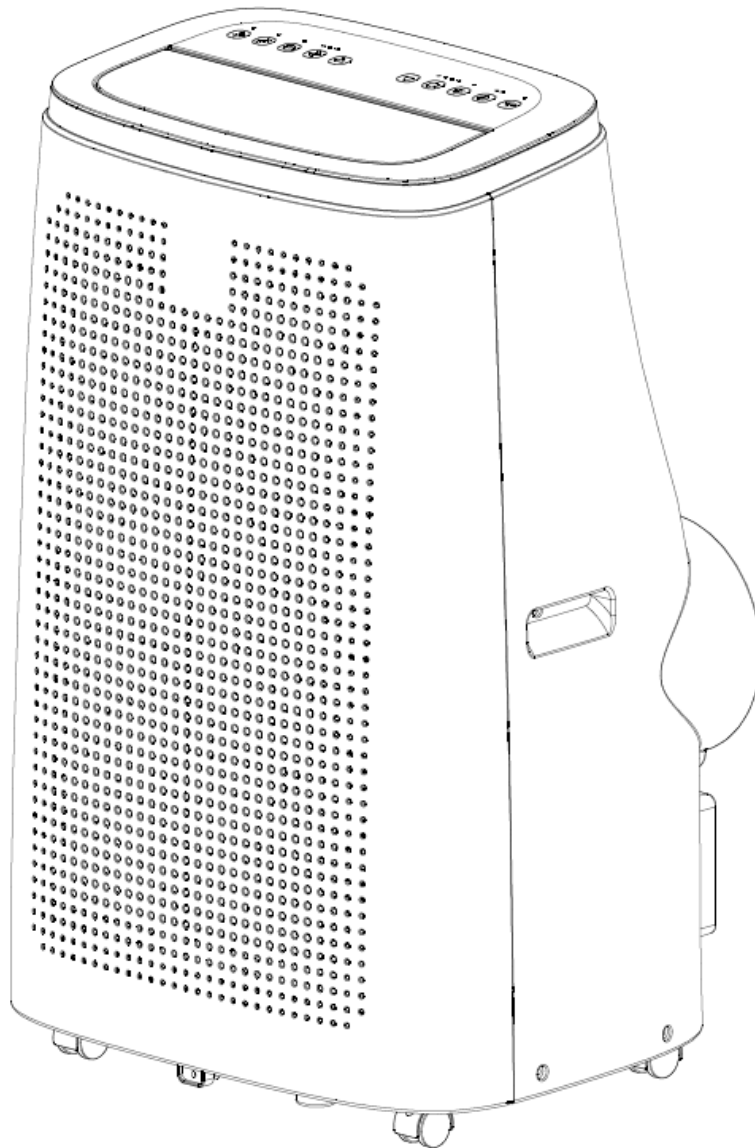

**MODEL#
A020B-10KR**

Content

I. Notes.....	3
II. Features and Components.....	5
III. Installation and Adjustment.....	7
IV. Control Setting.....	9
V. Drainage Instructions	12
VI. Maintenance.....	13
VII. Troubleshooting	14

Thank you for choosing the luxurious and elegant mobile air conditioning. Please keep the manual for later review, and read the manual carefully before use.

I. Notes

Notes:

*The air conditioning is only suitable for indoor use, and is not suitable for other applications.

*Follow local grid interconnection rules while installing the air conditioning and ensure that it is properly grounded. If you have any question on electrical installation, follow the instructions of the manufacturer, and if necessary, ask a professional electrician to install it.

*Place the machine in a flat and dry place and keep a distance of above 50cm between the machine and the surrounding objects or walls.

*After the air conditioning is installed, ensure that the power plug is intact and firmly plugged into the power outlet, and place the power cord orderly to prevent someone from being tripped or pulling out the plug.

*Do not put any object into the air inlet and outlet of the air conditioning. Keep the air inlet and outlet free from obstructions.

*When drainage pipes are installed, ensure that the drainage pipes are properly connected, and are not distorted or bended.

* While adjusting the upper and lower wind-guide strips of the air outlet, pluck it with hands gently to avoid damaging wind-guide strips.

*When moving the machine, make sure that it is in an upright position.

*The machine should stay away from gasoline, flammable gas, stoves and other heat sources.

* Don't disassemble, overhaul and modify the machine arbitrarily, otherwise it will cause a machine malfunction or even bring harm to persons and properties. To avoid danger, if a machine failure occurs, ask the manufacturer or professionals to repair it.

* Do not install and use the air conditioning in the bathroom or other humid environments.

* Do not pull the plug to turn off the machine.

* Do not place cups or other objects on the body to prevent water or other liquids from spilling into the air conditioning.

* Do not use insecticide sprays or other flammable substances near the air conditioning.

* Do not wipe or wash the air conditioning with chemical solvents such as gasoline and alcohol. When you need to clean the air conditioning, you must disconnect the power supply, and clean it with a half-wet soft cloth. If the machine is really dirty, scrub with a mild detergent.

* The appliance can be used by children aged from 8 years and above and persons with reduced physical, sensory or mental capabilities if they have been given supervision or instruction concerning use of the appliance in a safe way and understand the hazards involved. Children shall not play with the appliance. Cleaning and maintenance shall not be made by children without supervision.

* Risk of fire or explosion. Flammable refrigerant used. To be repaired only by trained service personnel. Do not puncture refrigerant tubing.

* Risk of fire or explosion. Dispose of properly in accordance with federal or local regulations. Flammable refrigerant used.

II. Features and Components

1. Features

New look, compact structure, streamlined machine, aristocratic atmosphere.

With cooling, heating (single cold without heating function), dehumidifying and fan function, Continuously Water Drainage Functions.

Automatic swing leaf in the outlet has automatic air swing function, and the outlet can be covered when the machine is turned off to prevent dust from entering the body.

LCD displays the control panel. The machine is beautiful and elegant. High-quality LCD remote control is equipped to facilitate operation.

Handles on both sides adopt dividing point design, so that it is easier to carry it and the body design is more luxury.

The structure of wrapping the power cord on the back facilitates users to hang the power cord without hanging it down to the ground and staining and damaging the power cord.

Outdoor interface is set high to facility assembly and keep the smooth flow of the heat pipe.

Air filtration capability.

Timing switch function.

Protection function of automatically restarting the compressor after three minutes, with a variety of other protection functions.

2. Components:

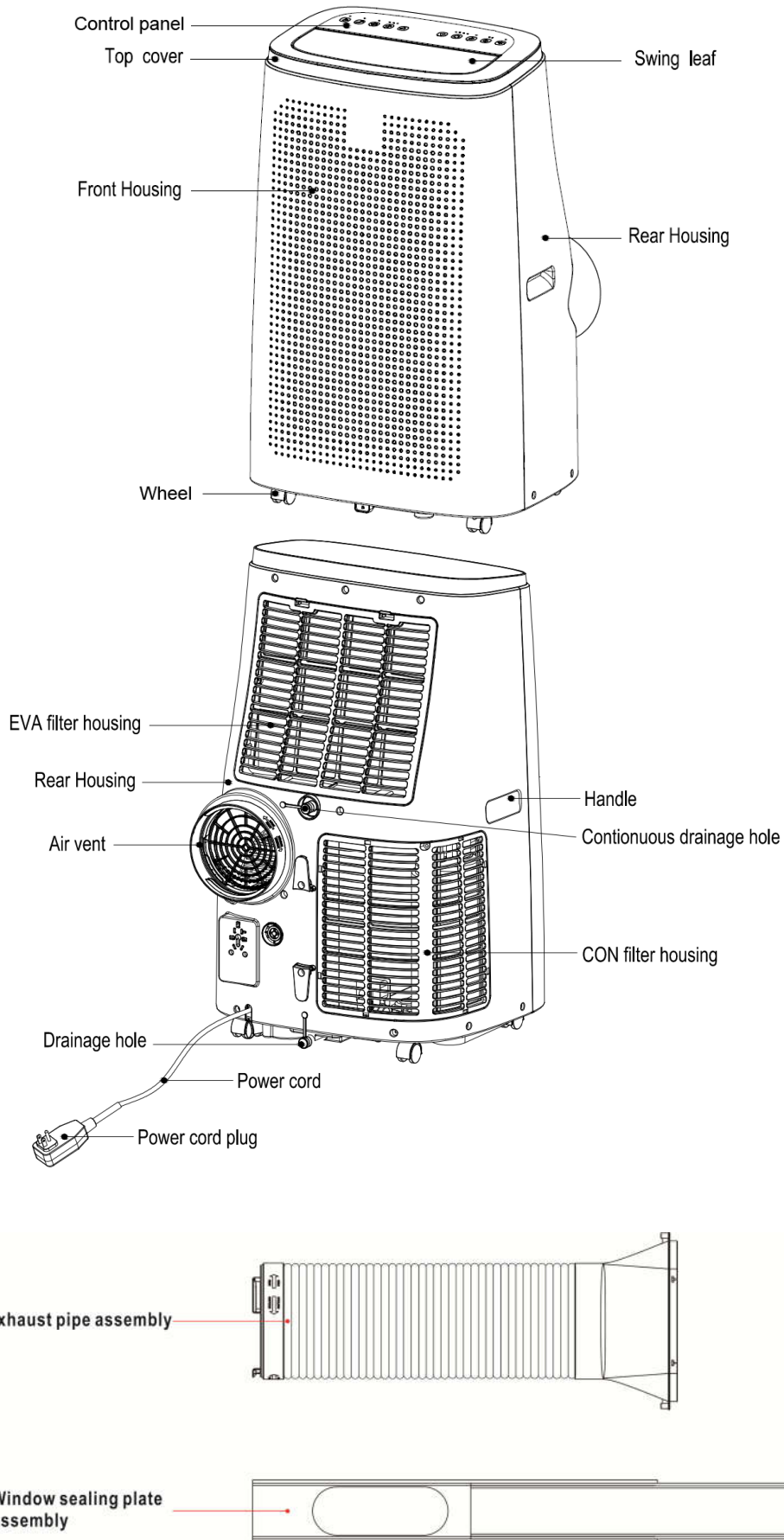

III. Installation and Adjustment

1. Installation:

Warning: before using the mobile air conditioning, keep it upright for at least two hours.

The air conditioning can be easily moved in the room. In the moving process, ensure that the air conditioning is in the upright position and the air conditioning should be placed on a flat surface. Do not install and use the air conditioning in the bathroom or other humid environments.

1.1 Install the heat pipe assembly (as shown in Figure 1): screw the heat pipe assembly (exhaust fitting end) into the exhaust port on the rear panel (counterclockwise).

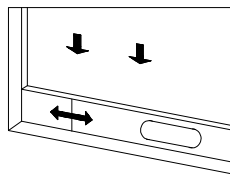
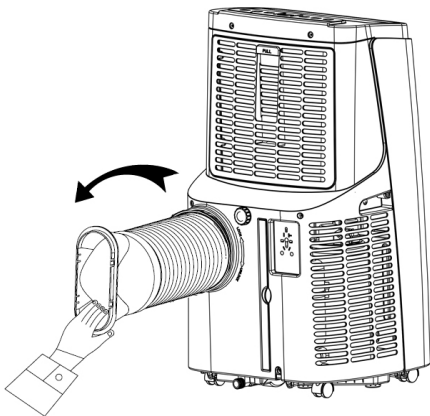

Figure2

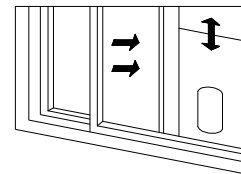

Figure3

1.2 Install the window sealing plate assembly

- 1) Half open the window, and mount the window sealing plate assembly to the window (as shown in Figure 2 and Figure 3); the assembly can be placed in horizontal and vertical direction.
- 2) Pull various components of the window sealing plate assembly open, adjust their opening distance to bring both ends of the assembly into contact with the window frame, and fix various components of the assembly.

1.3 Install the unit.

- 1) Move the machine with installed heat pipe and fittings, and the distance between the body and walls or other objects shall be at least 20inch, pic as shown below.

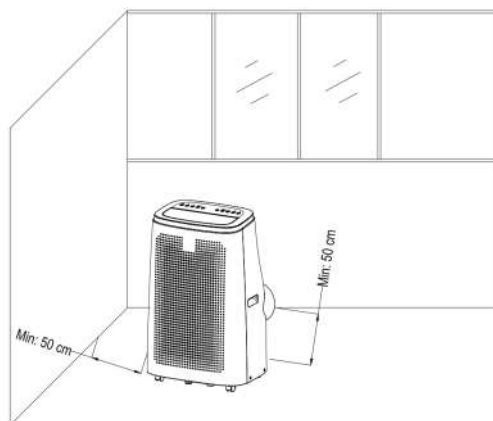

Figure 4

- 2) Elongate the heat pipe and snap the flat end of the heat pipe joints into the elliptical hole of the window sealing plate assembly (as shown in Figure 5 and Figure 6) .

Notes: 1. the flat end of the heat pipe joints must be snapped into place.

2. The pipe cannot be distorted nor has substantial turning (greater than 45 °). Keep the ventilation of the heat pipe unobstructed.

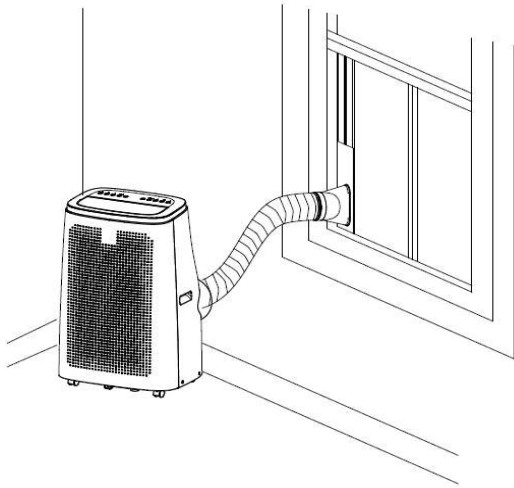

Figure5

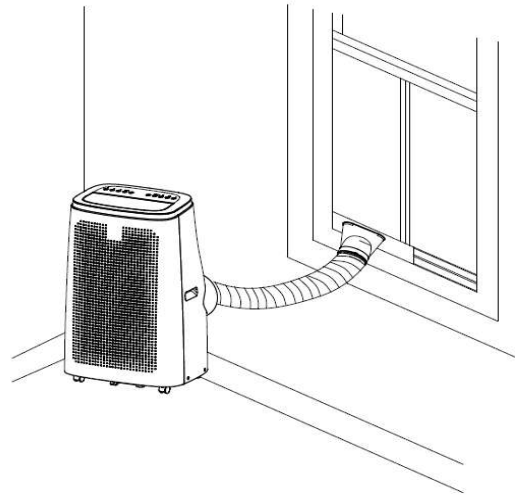
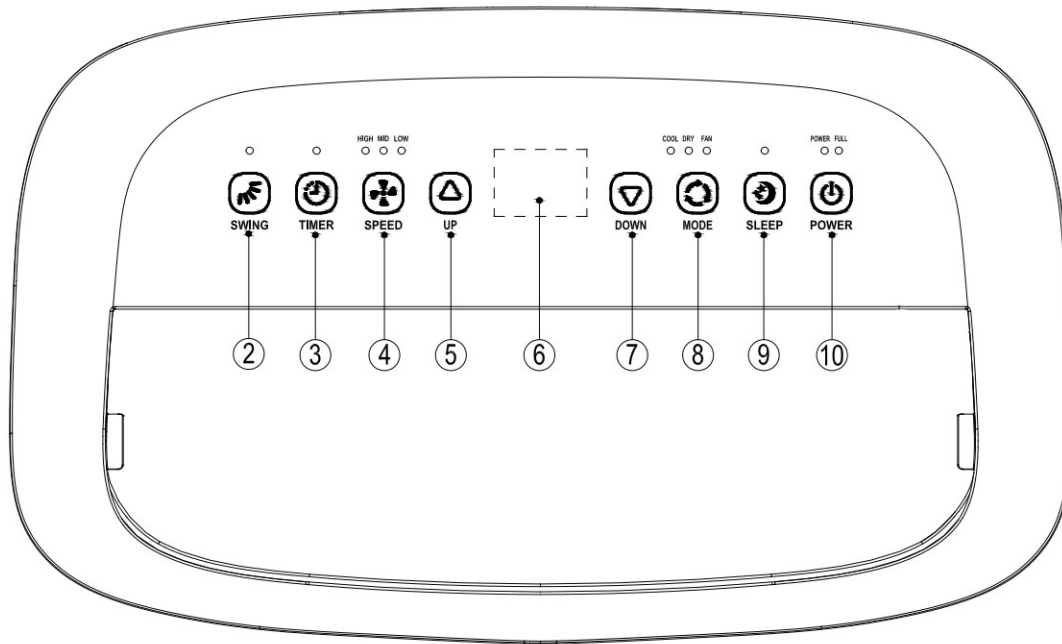

Figure 6

IV. Control Setting

I. Operating instructions:



2.Swing Button
5.Up Button
8.Mode Button

3.Timer Button
6.Display
9.Sleep Button

4.Speed Button
7.Down Button
10 Power Button

1.Power: Press the key to turn on and turn off the unit.

2.TIMER: Press TIMER button to set the unit automatically turn ON or OFF. Use the + and - buttons to program the hour increment.

3.FAN SPEED: In cooling, heating and fan mode, pressing the key to select high, middle, low fan speed. This function is not available in SLEEP mode and DEHUMIDIFYING mode.

4.UP: Pressing this button to increase the temperature setting or set up the timer to the required timer setting. This function is not available under FAN mode and DEHUMIDIFYING mode.

Simultaneously press UP and DOWN keys to switch between Celsius (°C) and Fahrenheit (°F)

5.DOWN: Pressing this button to decrease the temperature setting or set down the timer to the required timer setting. This function is not available under FAN mode and DEHUMIDIFYING mode.

6.Mode: In the case of power on, press this key to switch between cooling → fan → dry mode.







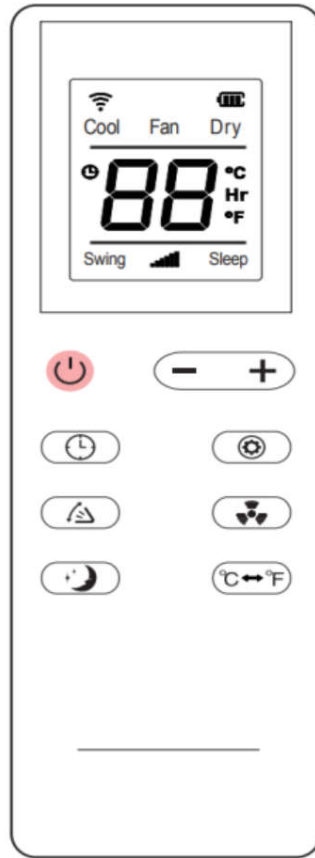

7.Sleep: In cooling Mode, pressing the sleep button to turn on the sleep mode, then the unit will work on Energy-Saving and quiet mode.

II. Operating Instructions of the Remote Control

Operation interface of the remote control is as follows



Instructions of key operation of the high-quality remote control are as follows:

1. Power: Press  the key to turn on or turn off the machine.
2. Mode: press  the key to switch between cooling, air supply, dehumidification mode.
3. Up: press  the key to increase temperature and timing set value.
4. Down: press  the key to reduce temperature and timing set value.
5. Fan: press  the key to select high, medium and low wind speed output circularly.
6. Timer: press  the key to set timing value.
7. Swing: Press  the key to fix the louver in your desired position.
8. press  the key to switch between Celsius and Fahrenheit.
9. Sleep Mode: Press  the key to turn on the sleep mode.

*NOTE: AAA 1.5VDC battery (not included)

III. A Variety of Protection Functions

3.1 Frost Protection Function:

In cooling, dehumidification or economic power saving mode, if the temperature of the exhaust pipe is too low, the machine will automatically enter protection status; if the temperature of the exhaust pipe rises to a certain temperature, it can automatically revert to normal operation.

3.2 Overflow Protection Function:

When water in the water pan exceeds the warning level, the machine will automatically sound an alarm, and the LDC temperature display area will show "FL". At this point, you need to move the drainage pipe connecting the machine or the water outlet to sewer or other drainage area to empty the water (details see *Drainage Instructions* at the end of this chapter). After the water is emptied, the machine will automatically return to the original state.

3.3 Automatic Defrosting (heating and cooling models have this function):

The machine has automatic defrosting function: during defrosting, heating symbol on the display screen will flash.

3.4. Automatic Thermal Protection:

To protect the service life of the machine, the machine has automatic thermal protection in heating mode. During the protection period, the compressor and the lower motor will stop operation and will automatically return to normal heating state after the temperature of the machine recovers.

3.5 Protection Function of the Compressor

To increase the service life of the compressor, it has a 3-minute delay booting protection function after the compressor is turned off.

V. Drainage Instructions

1. Manual drainage:

1) When the machine stops after the water is full, turn off the machine power and unplug the power plug.

Notes: Please move the machine carefully, so as not to spill the water in the water pan at the bottom of the body.

2) Place the water container below the side water outlet behind the body.

3) Unscrew the rotary knob and unplug rubber stopper, the water will automatically flow into the water container.

Notes: 1. Keep the rotary knob and rubber stopper properly.

2. During drainage, the body can be tilted slightly backwards.

3. If the water container cannot hold all the water, before the water container is full, stuff the water outlet with rubber stopper as soon as possible to prevent water from flowing to the floor or the carpet.

4) When the water is discharged, stuff rubber stopper, and tighten the rotary knob.

Notes: 1. Restart the machine after rubber stopper and rotary knob are installed, otherwise condensate water of the machine will flow to the floor or the carpet.

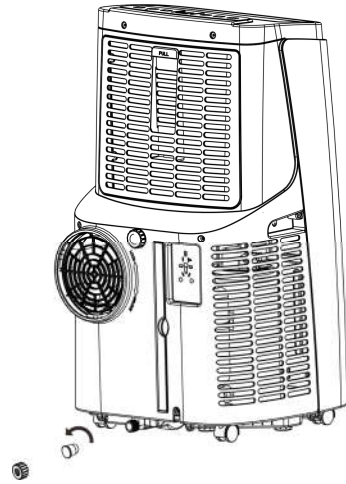

2. Continuous drainage (only applicable to cooling and dehumidification mode), as shown in figure:

1) Unscrew the rotary knob, and unplug rubber

2) Set the drainage pipe into the water outlet.

3) Connect the drainage pipe to the bucket.

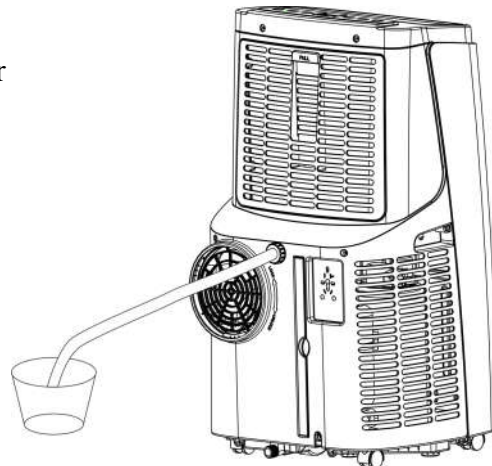

VI. Maintenance

Cleaning: before cleaning and maintenance, turn off the machine and unplug the plug.

1. Clean the surface

Clean with surface of machine with a wet soft cloth. Don't use chemicals, such as benzene, alcohol, gasoline, etc.; otherwise, the surface of the air conditioning will be damaged or even the whole machine will be damaged.

2. Clean the filter screen

1) If the filter screen is clogged with dust, and the effectiveness of the air conditioning is reduced, be sure to clean the filter screen once every two weeks.

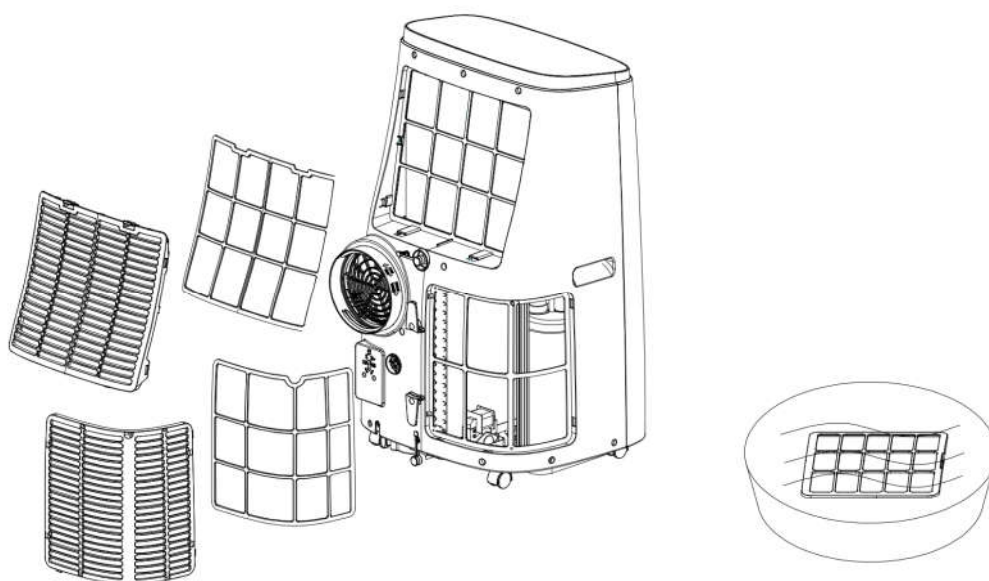

2) Clean the upper filter screen frame

① Clasp the wedging block of the filter screen frame with hands. Force down from the outside to remove the filter screen frame. Unscrew four screws fixing the filter screen and the rear housing to remove the EVA filter screen (as shown in the above figure).

② Put the filter screen into warm water with neutral detergent (about 40°C / 104°F) and dry it in the shade after rinsing clean.

Postseason Storage:

- 1: Unscrew the rotary knob, unplug rubber stopper, and discharge the water in the water pan into other water containers or directly tilt the body to discharge the water into other containers.
- 2: Turn on the machine, adjust it to low-wind ventilation mode, and maintain this state until the drainage pipe becomes dry, so as to keep the inside of the body in a dry state and prevent it from mildewing.
- 3: Turn off the machine, unplug the power plug, and wrap the power cord around the wrapping post; install rubber stopper and the rotary knob.
- 4: Remove the exhaust pipe and keep it properly.
- 5: Cover the air conditioning with a plastic bag. Put the air conditioning in a dry place, keep it out of the reach of children, and take dust control measures.
- 6: Remove batteries of the remote control and keep them properly.

Note: ensure that the body is placed in a dry place and keep all machine components properly.

VII. Troubleshooting

Do not repair or disassemble the air conditioning by yourself. Unqualified repair will lead to failure of the warranty card, and may cause damage to users or their properties.

Problems	Reasons	Solutions
The air conditioning does not work.	There is no electricity.	Turn it on after connecting it to a socket with electricity.
	The overflow indicator displays "FL".	Discharge the water inside.
	The ambient temperature is too low or too high	Recommend to use the machine in at the temperature of 7-35 °C (44-95 °F).
	In cooling mode, the room temperature is lower than the set temperature; in heating mode, the room temperature is higher than the set temperature.	Change the set temperature.
	In dehumidification mode, the ambient temperature is low.	The machine is placed in a room with an ambient temperature of greater than 17 °C (62 °F).
The cooling or heating effect is not good	There is direct sunlight.	Pull the Curtain.
	Doors or windows are open; there are a lot of people; or in cooling mode, there are other sources of heat.	Close doors and windows, and add new air conditioning.
	The filter screen is dirty.	Clean or replace the filter screen.
	The air inlet or outlet is blocked.	Clear obstructions.
Big Noise	The air conditioning is not placed on a flat surface.	Put the air conditioning on a flat and hard place (to reduce noise).
compressor does not work.	Overheat protection starts.	Wait for 3 minutes until the temperature is lowered, and then restart the machine.
The remote control does not work.	The distance between the machine and the remote control is too far.	Let the remote control get close to the air conditioning, and make sure that the remote control directly faces to the direction of the remote control receiver.
	The remote control is not aligned with the direction of the remote control receiver.	
	Batteries are dead.	Replace batteries.
Displays 'E1'.	The room temperature sensor is abnormal.	Check the room temperature sensor and related circuitry.
Displays 'E2'	The pipe temperature sensor is abnormal.	Check the pipe temperature sensor and related circuitry.

If problems not listed in the table occur or recommended solutions do not work, please contact the professional service organization or contact onlinesales@jhs8.com