

Use and Care Guide

KEY LARGO SIDE TABLE

Product Code: D71 M20715

KSN: 08824329-0

UPC Code: 885227002767

Date of Purchase: ____/____/____

Thank you for your purchase

Thank you for your purchase!

We are pleased that you have chosen Sears for your outdoor furniture purchase. We hope that you enjoy the unmatched quality, comfort, and style of your new patio set. Every piece is meticulously considered all the way down to the smallest details, exclusively for you, by our world class design team. We know you have a choice when it comes to your patio furniture needs, so from our team to yours, thank you for letting us be a part of your outdoors.

Table of Contents

Table of Contents.....	2
Safety Information.....	3
Set Up your Furniture Properly.....	3
Examine your furniture.....	3
Warranty.....	3
Care and Maintenance.....	4
Pre-Assembly.....	4
Planning Assembly.....	4
Observe weight Limits.....	4
Assembly Instructions	
Side table.....	5

Safety Information

SET UP YOUR FURNITURE PROPERLY

- Ensure that all parts are assembled properly and fully tightened as per the instructions.
- When placing in the desired location, ensure that all legs are resting on the same surface. You may adjust the legs levelers as required to ensure that the item stands in a rigid position.

EXAMINE YOUR FURNITURE

- Examine occasionally to ensure that there are no loose parts. If loose parts are found, they must be retightened fully before additional use.

Warranty

This limited warranty is extended to the original purchaser and applies to defects in material and workmanship of your patio furniture, provided your furniture is maintained with care and used only for personal, residential purposes.

WARRANTY

Frames are warranted to be free from defects in material or workmanship for a period of one (1) year.

Resin wicker is warranted to be free from defects in material or workmanship for a period of one (1) year.

Cushions are covered for a period of one (1) year against defects in material or workmanship

Exclusions: Items used for commercial, contract, or other non-residential purposes, or items damaged due to acts of nature, vandalism, misuse, or improper assembly is not covered. Discoloration and fading of the finish or fabrics as a result of chemicals or spills are not covered. Glass table top breakage and corrosion or rusting of hardware is not covered. If, within the stated warranty period, this product is found to be defective in material or workmanship, the purchaser must contact the customer service department at 1-888-577-9825 the manufacturer, at its option, will repair or replace the defectives parts. Proof of purchase (date register receipt) is required for warranty claims. It remains the customer's responsibility to pay for freight and packing charges to and from the service center. Warranty is to the original purchaser and is non-transferable. Any replacement of warranted items will be in the original style and color, or a similar style and color if the original is unavailable or has been discontinued. As some states do not allow exclusions or limitations on an implied warranty, the above exclusions and limitations may not apply. This warranty gives you specific rights, and you may also have other rights, which vary from state to state.

Customer service 1-888-577-9825

Care and Maintenance

- When not in use, protecting furniture from the elements is highly recommended.
- Wipe frame with a lightly damp cloth and dry completely, do not use bleach or solvents.
- Wash cushions with mild solution of soap and water, rinse thoroughly. Do not machine wash.

Pre-Assembly

PLANNING ASSEMBLY

To prevent damage, place all parts on a soft surface during assembly. Remove all protective caps before beginning assembly. It takes about 10 minutes for two person to complete all the assembly.

OBSERVE WEIGHT LIMITS

The recommended weight limits for the following products are listed below:





- Chair: 250lbs
- Swivel Chair: 250lbs
- Loveseat: 450lbs
- Ottoman: 150lbs
- Table: 50lbs
- Sofa: 650lbs
- Chaise: 250lbs

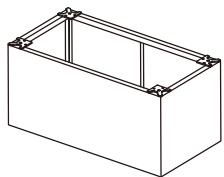
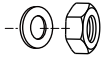

CAUTION: If you overload your furniture, injuries can occur.

Assembly Instructions

Package Contents

CODE	PARTS	DESCRIPTION	QTY.	CODE	PARTS	DESCRIPTION	QTY.
A		TABLE FRAME	1	D	 M8	NUTS & WASHERS	4
B		LEGS	4	E	 M8	CAPS FOR NUTS	4
C		TABLE TOP	1	F	 M8	ALLEN WRENCH	1



Safety Information

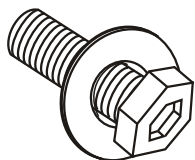

1. EVERY BOLT NEEDS TO BE USED WITH A WASHER.
2. DO NOT TIGHTEN BOLTS ALL THE WAY UNTIL YOU HAVE ASSEMBLED THE CHAIR. ONCE ASSEMBLY IS COMPLETE, GO BACK AND TIGHTEN EACH BOLT.

Assembly Instructions

- 1** Step 1: Connect four table legs B to the table frame A, cover the bolts with caps E.

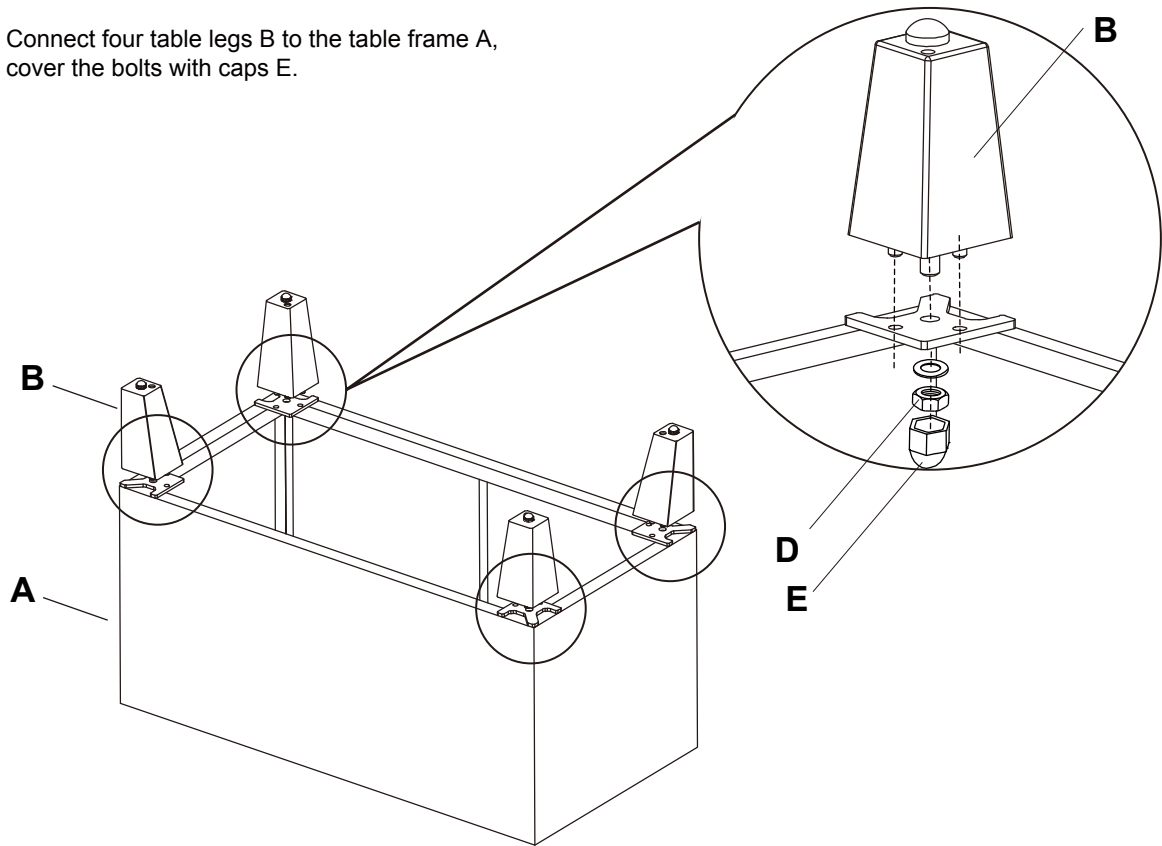

- 2** Step 2: Turn the side table upward as shown, place the glass table top on the table frame gently.

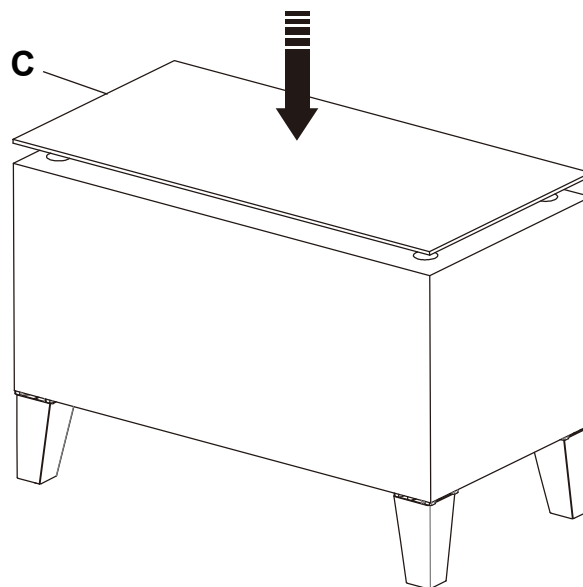

sears

Please refer to part numbers when reordering

For questions or comments about product:

Email: acs@americancustomerservice.com or Call toll-free: 1-888-577-9825
SERVICE HOURS: Monday – Friday 8:00AM to 8:00PM EST

Made in / Hech en CHINA

Distributed by Sears, Roebuck and Co., Hoffman Estates, IL 60179

See our extensive assortment of outdoor living products
on-line at www.sears.com and www.kmart.com