

THE NAVIGATOR



Bahamas™

FROZEN CONCOCTION MAKER®

The Best Margaritas Come From Margaritaville®



Model DM0600 Series User Manual

IMPORTANT SAFEGUARDS

WHEN USING ELECTRICAL APPLIANCES, BASIC SAFETY PRECAUTIONS SHOULD ALWAYS BE FOLLOWED, INCLUDING THE FOLLOWING:

- 1. READ ALL INSTRUCTIONS BEFORE USING.**
2. To protect against electric shock, do not immerse appliance, cord or plug in water or other liquids.
3. Close supervision is necessary when any appliance is used near children. This appliance should not be used by children.
4. Unplug from outlet when not in use, before putting on or taking off parts, and before cleaning.
5. Avoid contact with moving parts.
6. Do not operate any appliance with damaged cord or plug, after the appliance malfunctions, or is dropped or damaged in any manner. Contact 1-877-689-2737 for customer service.
7. Do not use outdoors.
8. Do not let cord hang over the edge of a table or counter or touch hot surfaces, including the stove.
9. Keep hands and utensils out of container while blending and/or ice shaving to reduce risk of severe injury to persons or damage to the unit. A rubber spatula may be used but must be used only when the appliance is not running.
10. Blades are sharp; handle carefully.
11. Always operate appliance with Jar Lid and Ice Reservoir Lid in place.
12. The use of attachments not recommended or sold by the manufacturer may cause fire, electric shock, or injury.
13. Do not use broken, chipped, or cracked Blending Jar or Ice Reservoir.
14. To reduce risk of injury to persons, never place Blending Blade Assembly on base without the Blending Jar properly attached.
15. Do not leave appliance unattended while it is operating.
16. To disconnect, turn control to off, then remove plug from wall outlet.

17. Do not use appliance for other than intended use.
18. Never place fingers or other utensils into feed or discharge areas.
19. Check Ice Reservoir for presence of foreign objects before using.
20. Be certain the Jar Lid and Ice Reservoir Lid are securely locked in place before operating appliance.
21. Do not blend hot liquids.

NOTE: NEVER SHAKE OR REMOVE BLENDER JAR DURING OPERATION AS JAR BLADE ASSEMBLY CAN GET DAMAGED.

SAVE THESE INSTRUCTIONS FOR HOUSEHOLD USE ONLY

Polarized Plug

This appliance has a polarized plug (one blade is wider than the other). As a safety feature, this plug will fit in a polarized outlet only one way. If the plug does not fit fully into the outlet, reverse the plug. If it still does not fit, contact a qualified electrician. Do not attempt to defeat this safety feature.

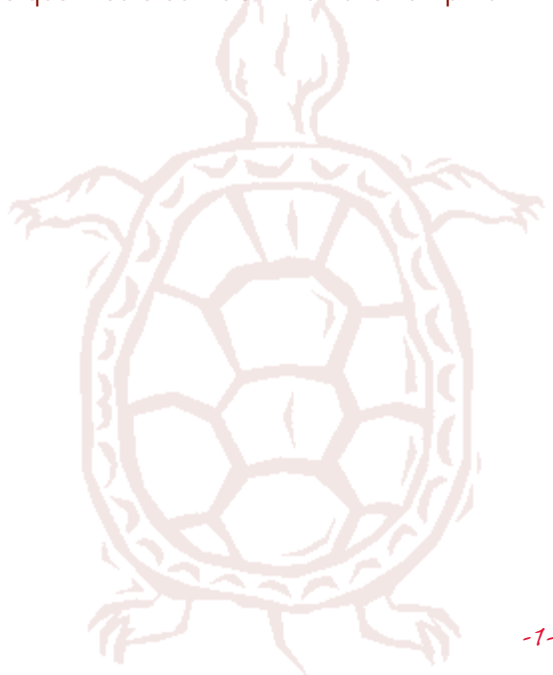



WELCOME

*Congratulations on your purchase of the Margaritaville®
Frozen Concoction Maker® – DM0600 Series!*

To learn more about Margaritaville® products,
please visit us at www.margaritavillecarg.com.

FROZEN CONCOCTION MAKER®

PARTS LIST

- 1 Ice Reservoir Lid** – Covers the Ice Reservoir.
- 2 Ice Reservoir** – Holds the ice for making frozen drinks.
- 3 Shaving Paddle** – Moves ice across the Shaving Blade.
- 4 Ice Hopper** – Holds Shaving Paddle.
- 5 Ice Shaving Blade with Deflector** – Shaves ice.
- 6 Shaving Blade Assembly Nut**
Holds Shaving Blade in place.
- 7 Ice Chute** – Directs ice from Ice Hopper into Blending Jar.
- 8 Blending Base** – Holds Blending Jar securely in place.
- 9 Control Panel** – Contains all necessary controls to operate your unit.

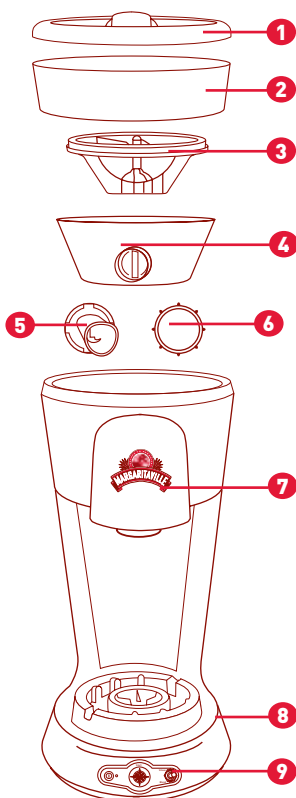

10 Jar Lid – Seals the blending jar.

11 Blending Jar – Maximum capacity of 36 oz. (1.07 L)

12 Blending Blade Sealing Ring – Seals the Blending Jar and Blending Base.

13 Blending Blade – Creates forward action when blending drinks.

14 Jar Base – Designed with wide base for stability.

15 Ice Melt Reservoir – Contains melted ice excess.

16 Cord Storage Door – Covers power cord storage area.

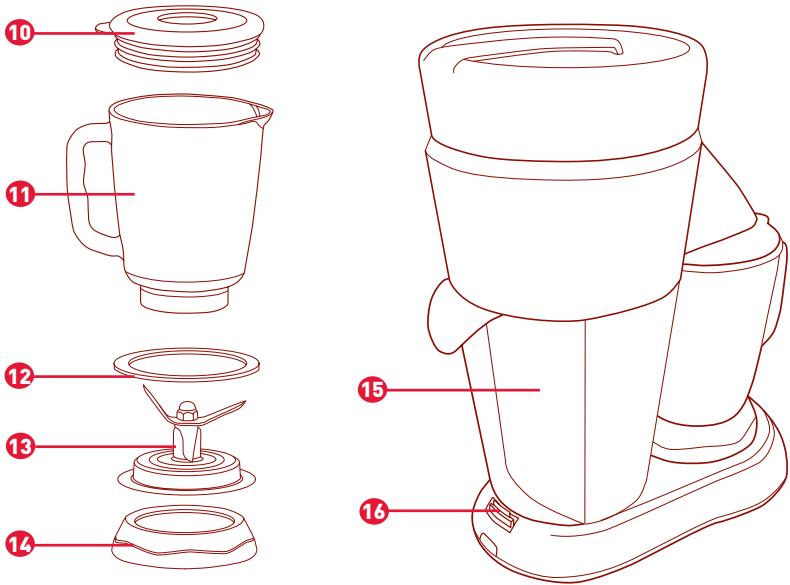

BAHAMAS™ MODEL CONTROL PANEL

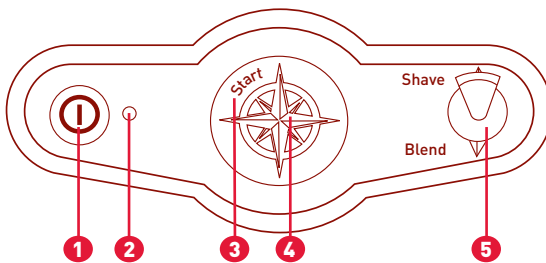

1 ON/OFF Button – Used to turn on for operation or to interrupt the automatic cycle.

2 Power Indicator Light – Once the ON/OFF button is engaged, the power indicator light will blink slowly.

3 Shave 'n Blend™ Start Button – Used to select and begin automatic Shave 'n Blend™ cycle.

4 Compass Rose Status Indicator Light

- Solid green – unit is ready to operate.
- Pulsing green – automatic cycle or manual mode engaged.
- Fast blinking red – fault mode [see troubleshooting section].

5 Blend Only/Shave Only Toggle Switch – Used to manually operate ice shaver and blender.

NO-BRAINER MIXING TOOL

The No-Brainer mixing tool includes measurement markings for making one batch of the top three frozen drink recipes.

For more recipes, go to margaritavillecargoo.com.

Pina Coladas, Daiquiris and Margaritas can be perfectly measured using the No-Brainer Mixing Tool.

1 Twist and Release Spout –

Twist to “EMPTY” position to release ingredients into blending jar. (Make sure tool is in “FILL” position when adding ingredients.)

2 Fill Level –

Follow the marks that indicate how much of each ingredient to add.

To clean the No-Brainer Mixing Tool, wash with warm water and soap. It is also acceptable to wash in the top rack of the dishwasher.

NOTE: The No-Brainer Mixing Tool separates into 2 parts for easy cleaning.

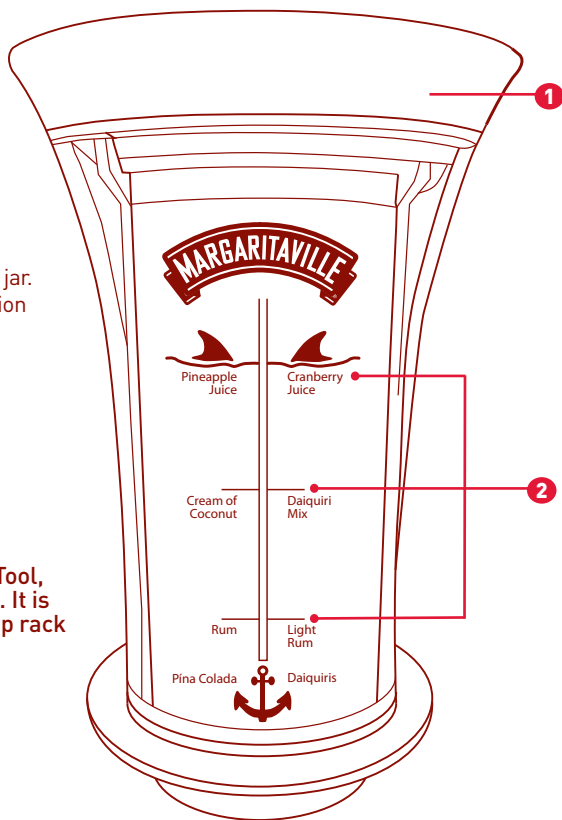

NOTE: THE NO-BRAINER MIXING TOOL HAS MEASUREMENTS FOR USE WITH 36-OUNCE AND 54-OUNCE JARS. RECIPES FOR USE WITH 36-OUNCE JARS ARE IN GREEN; RECIPES FOR USE WITH 54-OUNCE JARS ARE IN RED. BE SURE TO USE THE CORRECT RECIPE FOR YOUR SIZE JAR.

MAKING FROZEN DRINKS

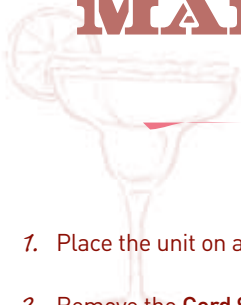

1. Place the unit on a clean dry flat surface.
2. Remove the **Cord Storage Door** by pushing down on the release tab located on the **Cord Storage Door** (Figure 1). Remove the power cord and plug the unit into a standard 120 Volt wall socket. Replace the **Cord Storage Door** and position the power cord in the slot below the cord storage release tab.
3. Install the **Ice Reservoir** to the unit by first removing the ice reservoir lid (turning it clockwise to the "unlock" position) (Figure 2).
 - 3a. Then place the ice reservoir (without the lid) on top of the unit and lock into position by turning counter-clockwise (Figure 3).
4. Fill the **Ice Reservoir** with ice cubes (Figure. 4).

NOTE: NEVER PUT ANYTHING BUT ICE IN THE ICE RESERVOIR.

5. Replace the **Ice Reservoir Lid** and rotate counterclockwise to the locked position.
6. Lift and remove the **Blending Jar**. The **Ice Chute** is spring-loaded and can be pushed up.

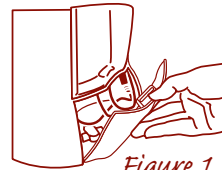

Figure 1

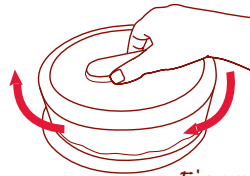

Figure 2

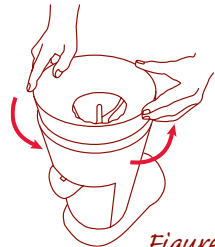

Figure 3

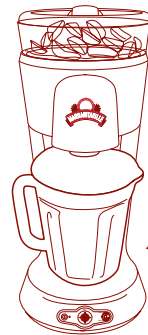

Figure 4

For Best Results: use ice that has been out of the freezer between 10 to 15 minutes

7. Remove **Blending Jar Lid**.
8. Add appropriate amount of liquid ingredients to the **Blending Jar**.

8a. Make sure top is set to "FILL" position. Follow guidelines on **No-Brainer Mixing Tool** for adding ingredients, using 36-ounce recipe.



The Best Margarita Recipe

Amount: 3 drinks

Ingredients	3 Drinks	
	fl oz	ml
Margaritaville® Gold Tequila	4	120
Triple Sec	1	30
Lime Juice	2	60
Orange Juice	2	60
Margaritaville® Margarita Mix	4	120

8b. Place the **No-Brainer Mixing Tool** on top of assembled blending jar and twist to "EMPTY" position to release mix. Remove **No-Brainer Mixing Tool**.

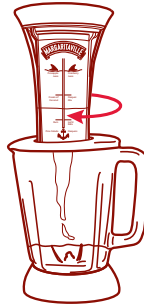

FOR REFERENCE ONLY

- in case your No-Brainer Mixing Tool is missing. (I bet the neighbors have it!)

9. Replace **Blending Jar Lid** and return **Blending Jar to Blending Base** by pushing up on the **Ice Chute** with the **Blending Jar** and then placing it on the **Blending Base**.
10. Push the **ON/OFF** button to turn the unit on (power indicator light will blink slowly).

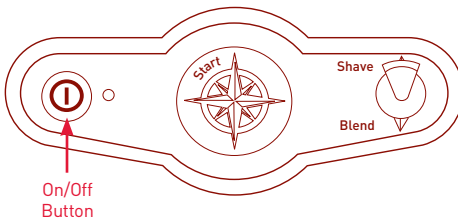
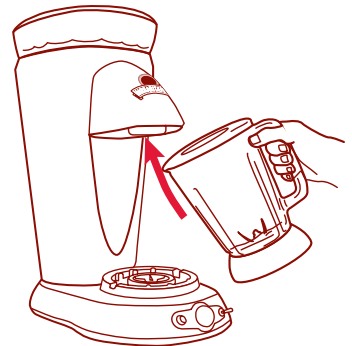

AUTOMATIC SHAVE 'N BLEND™ CYCLE

11. Start the automatic **Shave 'n Blend™** cycle by pushing the **Shave 'n Blend™** start button.
12. The unit will shave ice for the appropriate time. The blender will start automatically. The unit will stop at the completion of the cycle.

NOTE: DURING THE SHAVE AND BLEND CYCLE THE COMPASS ROSE STATUS INDICATOR LIGHT WILL PULSE GREEN TO INDICATE THE CYCLE PROGRESS.

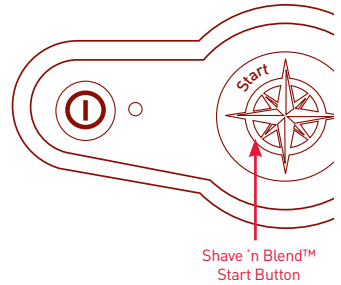

13. The status indicator light will return to solid green to indicate the unit is ready to make more drinks.
14. To serve:
 - a. Lift and remove the **Blending Jar**.
 - b. Remove **Blending Jar Lid**.
 - c. Pour and enjoy.



NOTE: To remove excess ice from the Ice Reservoir hold the Shave Only/Blend Only Toggle Switch in the Shave Only (up) position until the Ice Reservoir is empty. WARNING: DO NOT PLACE FINGERS IN THE ICE HOPPER. THE SHAVING BLADE IS SHARP AND COULD CAUSE INJURY.

15. Turn off the unit.
16. Periodically check the **Ice Melt Reservoir** and empty as needed.

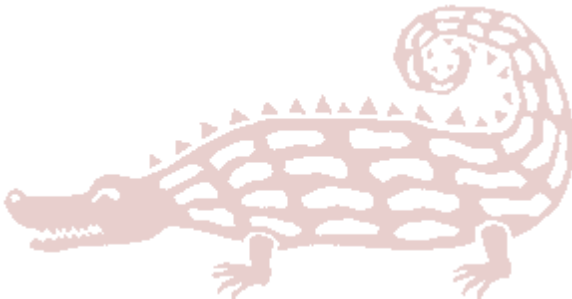
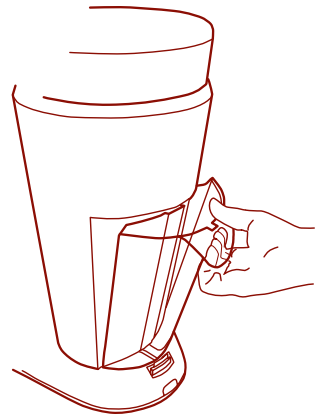

MANUAL CYCLE

To make a thicker drink:

- Hold the “Blend Only/Shave Only” Toggle Switch in the Shave Only position to add more ice to the Blending Jar.
- To stop adding ice, release the toggle switch.
- To mix the newly added ice into the drink, hold the Blend Only/Shave Only Toggle Switch in the Blend Only (down) position until the desired consistency is achieved. To stop the blending, release the Toggle Switch.
- Use less drink mixer than in recipe.
(ex. use 12 oz. (354 mL) or less liquid ingredients)

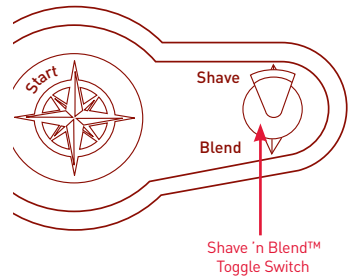

To make a thinner drink:

- Hold the Blend Only/Shave Only Toggle Switch in the Blend Only (down) position until the desired consistency is achieved.
- To stop blending release the Toggle Switch.
- Add more drink mixer than in recipe
(use 14 oz. (414 mL) or more of total mix).

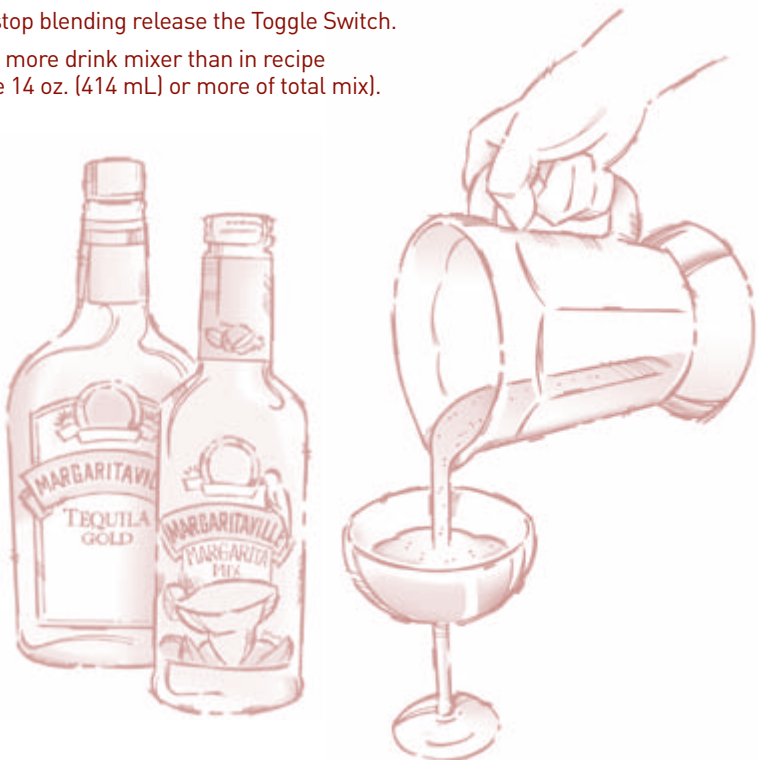

CLEANING AND MAINTENANCE

IMPORTANT: Your Blending Jar, Shaving and Blending Blades are subject to wear during normal use. Always inspect for nicks, chips, or cracks. Always inspect for broken, cracked, or loose blades. If the Jar or Shaving and Blending Blades are damaged, do not use. Call our toll-free customer service number, 1-877-689-2737, to obtain replacement parts.

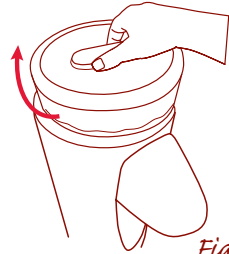

Figure 1

1. **Make sure unit is unplugged.** Place on a clean dry surface. Turn the unit so the back is facing you. Remove the **Ice Reservoir Lid** by turning clockwise to the unlock position (Figure 1).

2. To remove the **Ice Reservoir**, grasp the reservoir with your hand, turn clockwise, and lift to remove (Figure 2).

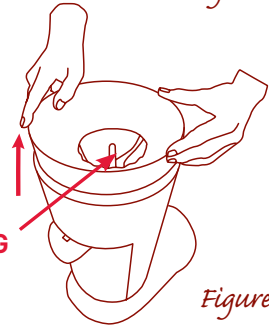

Figure 2

Note the location of the **Shaving Blade** inside the Ice Hopper (Figure 2).

WARNING: DO NOT PLACE FINGERS INSIDE THE ICE HOPPER NEAR THE SHAVING BLADE. BLADE IS SHARP HANDLE CAREFULLY.

NOTE: To reassemble, install ice reservoir to the unit first, then attach ice reservoir lid.

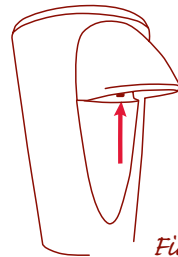

Figure 3

3. To Remove the **Shaving Paddle**, press the button located underneath the **Ice Chute**. If the button cannot be pressed, rotate the **Shaving Paddle** for a half turn and retry (Figure 3).

While pressing the button, rotate the Shaving Paddle counter-clockwise (to the left) by placing fingers in the ridges of the **Shaving Paddle** and unscrew. This will expose the **Ice Hopper** and **Shaving Blade**.

To re-assemble the **Shaving Paddle**, simply replace it into the threaded insert and rotate clockwise. Hand tighten only (Figure 4).

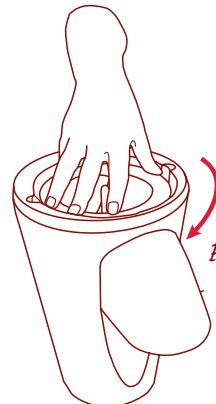
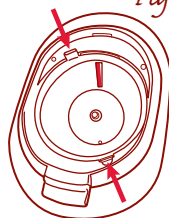

Figure 4

4. Press the two Ice Hopper release catches and lift the Ice Hopper to remove (Figure 5).

Figure 5



PLEASE FOLLOW THE INSTRUCTIONS BELOW TO SAFELY REMOVE THE SHAVING BLADE ASSEMBLY FROM THE ICE HOPPER.

5. Turn the Shaving Blade Assembly Nut counter clockwise (to the left) and remove, then remove the Shaving Blade and store in a safe place. (Figure 6).

Figure 6



BE SURE TO RINSE THE SHAVING BLADE AND DRY THOROUGHLY BEFORE STORING.

6. Carefully lift the Blending Jar straight up to remove. The Ice Chute is spring-loaded and can be pushed up. If the Blending Jar is not easily removed, rock gently and lift. Do not twist.
7. Turn the Blending Jar upside down and unscrew the Jar Base. Carefully remove the Blending Blade, and Blending Blade Sealing Ring.

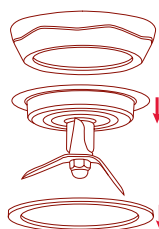

WARNING: THE BLENDING BLADE IS SHARP. HANDLE WITH CARE.

8. To remove the Ice Melt Reservoir hold the unit still and pull straight out on the handle.
9. Blending Jar Lid, Blending Jar, Blending Blade, Blending Blade Sealing Ring, No-Brainer Mixing Tool, Jar Base and Ice Melt Reservoir can be safely washed in the top rack of your dishwasher. Use only top rack. Failure to do so will result in damage. The Ice Reservoir Lid, Ice Reservoir, Shaving Paddle, Ice Hopper, Ice Deflector Blade Assembly, Shaving Blade and Ice Melt Reservoir are only exposed to ice and water and they should be rinsed with soap and warm water and allowed to air dry.



10. Use a damp cloth to clean the outside of the unit.

WARNING: UNPLUG UNIT BEFORE CLEANING. DO NOT USE SOLVENTS. NEVER IMMERSE THE UNIT IN WATER.

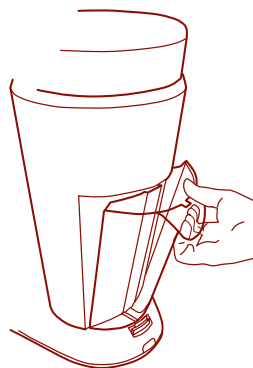

Troubleshooting

If the Power Indicator Light does not light:

Check that the unit is plugged into a working power outlet.

If liquid leaks from the base of the Blending Jar:

Remove it from the unit and check that the Blending Blade Sealing Ring is properly installed and that the Blending Jar Base is tightened.

If water leaks from the unit: Empty the Ice Melt Reservoir.

If the Blending Jar overflows during the Shave 'n Blend™ cycle:

Follow the drink recipe included in “making frozen drinks” section and make sure to not exceed the specified total volume.

If the Blending Jar will not sit on the Blending Base:

Remove it from the unit and check for ice on the Blending Base.

WARNING: unplug the unit before removing ice from the Blending Base.

If the unit is in fault mode (fast blinking red status compass rose indicator light):

Check that the Ice Reservoir and Ice Reservoir Lid are properly installed and in the lock position.

If the drink is too watery: Make sure to follow the recipe guide (pg.5) or manually shave more ice until the desired consistency is achieved.

Dos and Don'ts

DO NOT place fingers into the Blending Jar or Ice Hopper. The blades in this unit are sharp and could cause injury.

DO NOT place Blending Jar onto Blending Base while motor is running. The spinning Blending Base could damage the Blending Jar.

DO NOT twist Blending Jar when removing. Simply lift and remove. Twisting the Blending Jar could loosen the Blending Jar Base causing it to leak.

DO NOT put hot liquid into the Blending Jar. Hot liquids could be ejected during the blending process causing injury.

DO NOT place ice, frozen foods or very cold liquids into a Blending Jar which has come directly from a hot dishwasher. The sudden change in temperature could cause the Blending Jar to crack.

DO NOT place very hot liquids or foods into a Blending Jar that has come directly from the freezer. The sudden change in temperature could cause the Blending Jar to crack.

DO follow the cleaning and maintenance instructions prior to your first use and after subsequent uses.

DO unplug the unit when not in use.

1 Year Limited Warranty

Sunbeam Products, Inc, d/b/a Jarden Consumer Solutions or if in Canada, Sunbeam Corporation (Canada) Limited d/b/a Jarden Consumer Solutions (collectively "Sunbeam") warrants that for a period of one year from the date of purchase, this product will be free from defects in material and workmanship. Sunbeam, at its option, will repair or replace this product or any component of the product found to be defective during the warranty period. Replacement will be made with a new or remanufactured product or component. If the product is no longer available, replacement may be made with a similar product of equal or greater value. This is your exclusive warranty.

This warranty is valid for the original retail purchaser from the date of initial retail purchase and is not transferable. Keep the original sales receipt. Proof of purchase is required to obtain warranty performance. Sunbeam dealers, service centers, or retail stores selling Sunbeam products do not have the right to alter, modify or any way change the terms and conditions of this warranty.

This warranty does not cover normal wear of parts or damage resulting from any of the following: negligent use or misuse of the product, use on improper voltage or current, use contrary to the operating instructions, disassembly, repair or alteration by anyone other than Sunbeam or an authorized Sunbeam service center. Further, the warranty does not cover: Acts of God, such as fire, flood, hurricanes and tornadoes.

What are the limits on Sunbeam's Liability?

Sunbeam shall not be liable for any incidental or consequential damages caused by the breach of any express, implied or statutory warranty or condition.

Except to the extent prohibited by applicable law, any implied warranty or condition of merchantability or fitness for a particular purpose is limited in duration to the duration of the above warranty.

Sunbeam disclaims all other warranties, conditions or representations, express, implied, statutory or otherwise.

Sunbeam shall not be liable for any damages of any kind resulting from the purchase, use or misuse of, or inability to use the product including incidental, special, consequential or similar damages or loss of profits, or for any breach of contract, fundamental or otherwise, or for any claim brought against purchaser by any other party.

Some provinces, states or jurisdictions do not allow the exclusion or limitation of incidental or consequential damages or limitations on how long an implied warranty lasts, so the above limitations or exclusion may not apply to you.

This warranty gives you specific legal rights, and you may also have other rights that vary from province to province, state to state or jurisdiction to jurisdiction.

How to Obtain Warranty Service

If you have any question regarding this warranty or would like to obtain warranty service, please call 1- 877-689-2737 and a convenient service center address will be provided to you.

In the U.S.A., this warranty is offered by Sunbeam Products, Inc. located in Boca Raton, Florida 33431.

PLEASE DO NOT RETURN THIS PRODUCT TO ANY OF THESE ADDRESSES OR TO THE PLACE OF PURCHASE.



DO NOT RETURN THIS PRODUCT TO THE PLACE OF PURCHASE

For product questions:
Jarden Consumer Services U.S.A.
1-877-689-2737

www.margaritavillecargo.com

©2012 Sunbeam Products, Inc. doing business as Jarden Consumer Solutions. All rights reserved.
Distributed by Sunbeam Products, Inc. doing business as Jarden Consumer Solutions,
Boca Raton, Florida Boca Raton, Florida 33431.

Margaritaville® is a registered trademark of Margaritaville®, used with permission.

Printed in China

P. N. 163638

SPR-1012-759