



GAS RANGE

COS-GRP304

COS-GRP366

COS-GRP486G

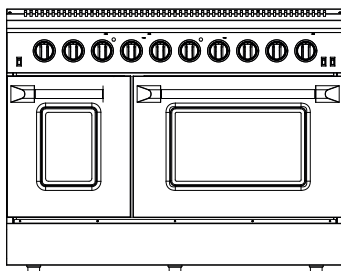
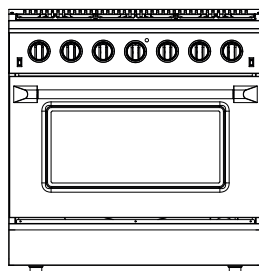
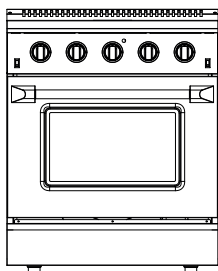

GRP SERIES SLIDE-IN RANGE

USER MANUAL

IMPORTANT: READ AND SAVE THESE INSTRUCTIONS.
FOR RESIDENTIAL USE ONLY.

INSTALLER: PLEASE LEAVE THESE INSTRUCTIONS WITH THIS UNIT FOR
THE OWNER.

OWNER: PLEASE RETAIN THESE INSTRUCTIONS FOR FUTURE
REFERENCE.

THANK YOU FOR YOUR PURCHASE

Thank you for your purchase. We know that you have many brands and products to choose from and we are honored to know that you have decided to take one of our products into your home and hope that you enjoy it.

COSMO Appliances are designed according to the strictest safety and performance standard for the North American market. We follow the most advanced manufacturing philosophy. Each appliance leaves the factory after thorough quality inspection and testing. Our distributors and our service partners are ready to answer any questions you may have regarding how to install, use and care for your products. We hope that this manual will help you learn to use the product in the safest and most effective manner.

Before using this product, please read through this manual carefully. Keep this user manual in a safe place for future reference. Please ensure that other persons using this product are familiar with these instructions as well.

If you have any questions or concerns, please contact the dealer from whom you purchased the product, or contact our Customer Support at:

1-888-784-3108

Reach us online at:

www.cosmoappliances.com

TABLE OF CONTENTS

RANGE SAFETY	4
Anti-tip Device	6
Important Safety Instructions	7
OVERVIEW	11
Range Layout.....	12
Control Panel	13
FEATURES	14
OPERATION	15
Gas Surface Burners	15
Before Using the Gas Surface Burners	15
Using the Gas Surface Burners	16
Using the Proper Cookware.....	18
Oven	20
Before Using the Oven	20
Before Using the Oven for the First Time	20
Oven Vent	21
Using Oven Racks	21
Preheating	22
Oven Controls	23
Bake	24
Broil	25
Convection Bake.....	26
Tips and Techniques	27
RANGE CARE AND MAINTENANCE	29
Cleaning.....	29
TROUBLESHOOTING	32
Cooktop Problems.....	32
Oven Problems	34
Baking Problems.....	35
LIMITED WARRANTY	37

RANGE SAFETY

READ ALL INSTRUCTIONS BEFORE USING THE APPLIANCE

Your safety and the safety of others are very important.

We have provided many important safety messages in this manual and on your appliance. Always read and obey all safety messages.



This is the safety alert symbol.

This symbol alerts you to potential hazards that can kill or hurt you and others.

All safety messages will follow the safety alert symbol and either the word "WARNING" or "CAUTION." These words mean:



You can be killed or seriously injured if you don't follow instructions.



A potentially hazardous situation which, if not avoided, could result in minor or moderate injury.

All safety messages will tell you what the potential hazard is, tell you how to reduce the chance of injury, and tell you what can happen if the instructions are not followed.

In the State of Massachusetts, the following installation instructions apply:

- Installations and repairs must be performed by a qualified or licensed contractor, plumber, or gasfitter qualified or licensed by the State of Massachusetts.
- If using a ball valve, it shall be a T-handle type.
- A flexible gas connector, when used, must not exceed 3 feet.

California Proposition 65 Warning



Cancer and Reproductive Harm - www.P65Warnings.ca.gov.

WARNING



FIRE AND EXPLOSION HAZARD

If the information in this manual is not followed exactly, a fire or explosion may result causing property damage, personal injury or death.

- Do not store or use gasoline or other flammable vapors and liquids in the vicinity of this or any other appliance.
- **WHAT TO DO IF YOU SMELL GAS**
 - Do not try to light any appliance.
 - Do not touch any electrical switch.
 - Do not use any phone in your building.
 - Clear the room, building, or area of all occupants.
 - Immediately call your gas supplier from a neighbor's phone. Follow the gas supplier's instructions.
 - If you cannot reach your gas supplier, call the fire department.
- Installation and service must be performed by a qualified installer, service agency or the gas supplier.

WARNING

Never Operate the Top Surface Cooking Section of this Appliance Unattended.

- Failure to follow this warning statement could result in fire, explosion, or burn hazard that could cause property damage, personal injury, or death.
- If a fire should occur, keep away from the appliance and immediately call your fire department.

DO NOT ATTEMPT TO EXTINGUISH AN OIL/GREASE FIRE WITH WATER.

WARNING



TIP OVER HAZARD

- A child or adult can tip the range and be killed.
- Install anti-tip bracket to wall per installation instructions.
- Slide range back so rear range pin is under the anti-tip bracket.
- Re-engage the anti-tip bracket if range is moved.
- Do not operate the range without anti-tip bracket installed and engaged.
- Failure to follow these instructions can result in death or serious burns to children and adults.

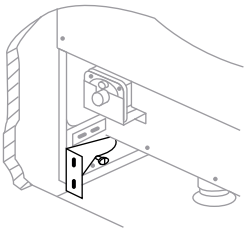

Making sure the anti-tip bracket is installed:

- Slide range forward.
- Safely tilt the front of the range upward slightly and slide range back.
- Making sure the pin slides under the anti-tip bracket.

WARNING: Gas leaks cannot always be detected by smell.

Gas suppliers recommend that you use a gas detector approved by UL or CSA. For more information, contact your gas supplier.

WARNING: Do not install a ventilation system that blows air downward toward this cooking appliance. This type of ventilation system may cause ignition and combustion problems with this cooking appliance resulting in personal injury or unintended operation.

WARNING: This appliance is intended for normal residential use. It is not approved for commercial use, outdoor installation, or any other application not specifically allowed by this manual.

IMPORTANT SAFETY INSTRUCTIONS

WARNING: To reduce the risk of fire, electrical shock, injury to persons, or damage when using the range, follow basic precautions, including the following:

- **WARNING:** TO REDUCE THE RISK OF TIPPING OF THE RANGE, THE RANGE MUST BE SECURED BY PROPERLY INSTALLED ANTI-TIP DEVICES. TO CHECK IF THE DEVICES ARE INSTALLED PROPERLY, SLIDE RANGE COMPLETELY FORWARD, LOOK FOR ANTI-TIP BRACKET SECURELY ATTACHED TO THE FLOOR OR WALL, AND SLIDE RANGE BACK SO THE REAR RANGE FOOT IS UNDER ANTI-TIP BRACKET.
- **WARNING:** NEVER use this appliance as a space heater to heat or warm the room. Doing so may result in carbon monoxide poisoning and overheating of the oven.
- **WARNING:** NEVER cover any slots, holes or passages in the oven bottom or cover an entire rack with materials such as aluminum foil. Doing so blocks airflow through the oven and may cause carbon monoxide poisoning. Aluminum foil linings may also trap heat, causing a fire hazard.
- **CAUTION:** Do not store items of interest to children in cabinets above a range or on the back guard of a range – children climbing on the range to reach items could be seriously injured.
- Do Not Leave Children Alone – Children should not be left alone or unattended in area where range is in use. They should never be allowed to sit or stand on any part of the range.
- Wear Proper Apparel – Loose-fitting or hanging garments should never be worn while using the range.
- User Servicing – Do not repair or replace any part of the range unless specifically recommended in the manual. All other servicing should be referred to a qualified technician.
- Storage in or on Range – Flammable materials should not be stored in an oven or near surface units.
- This appliance is not intended for storage.

READ AND SAVE THESE INSTRUCTIONS

IMPORTANT SAFETY INSTRUCTIONS

- Do Not Use Water on Grease Fires – Smother fire or flame or use dry chemical or foam-type extinguisher.
- Use Only Dry Potholders – Moist or damp potholders on hot surfaces may result in burns from steam. Do not let potholder touch hot heating elements. Do not use a towel or other bulky cloth.
- Never Leave Surface Units Unattended at High Heat Settings – Boilover causes smoking and greasy spillovers that may ignite.
- Glazed Cooking Utensils – Only certain types of glass, glass/ceramic, ceramic, earthenware, or other glazed utensils are suitable for range-top service without breaking due to the sudden change in temperature.
- Utensil Handles Should Be Turned Inward and Not Extend Over Adjacent Surface Units – To reduce the risk of burns, ignition of flammable materials, and spillage due to unintentional contact with the utensil, the handle of a utensil should be positioned so that it is turned inward, and does not extend over adjacent surface units.
- Disconnect power before servicing.
- Proper Installation – The appliance, when installed, must be electrically grounded in accordance with local codes, or in the absence of local codes, with the National Electrical Code, ANSI/NFPA 70 or the Canadian Electrical Code, CSA C22.1-02. In Canada, the appliance must be electrically grounded in accordance with Canadian Electrical Code. Be sure your appliance is properly installed and grounded by a qualified technician.
- Injuries may result from misuse of appliance doors or drawers such as stepping, leaning, or sitting on the doors or drawers.
- Maintenance – Keep range area clear and free from combustible materials, gasoline, and other flammable vapors and liquids.
- Do not let cooking grease or other flammable materials accumulate in or near the range. Grease in the oven or on the cooktop may ignite.
- Top burner flame size should be adjusted so it does not extend beyond the edge of the cooking utensil. This instruction is based on safety considerations.

READ AND SAVE THESE INSTRUCTIONS

IMPORTANT SAFETY INSTRUCTIONS

- Do not use replacement parts that have not been recommended by the manufacturer (e.g. parts made at home using a 3D printer).
- Clean Cooktop With Caution – If a wet sponge or cloth is used to wipe spills on a hot cooking area, be careful to avoid steam burn. Some cleaners can produce noxious fumes if applied to a hot surface.
- Use Care When Opening Door – Let hot air or steam escape before removing or replacing food.
- Do Not Heat Unopened Food Containers – Build-up of pressure may cause container to burst and result in injury.
- Keep Oven Vent Ducts Unobstructed.
- Never broil with door open. Open-door broiling is not permitted due to overheating of control knobs.
- Placement of Oven Racks – Always place oven racks in desired location while oven is cool. If rack must be moved while oven is hot, do not let potholder contact hot heating element in oven.
- Care must be taken to prevent aluminum foil and meat probes from contacting heating elements.
- **DO NOT TOUCH HEATING ELEMENTS OR INTERIOR SURFACES OF OVEN** – Heating elements may be hot even though they are dark in color. Interior surfaces of an oven become hot enough to cause burns. During and after use, do not touch, or let clothing or other flammable materials contact heating elements or interior surfaces of oven until they have had sufficient time to cool. Other surfaces of the appliance may become hot enough to cause burns – among these surfaces are cooktop, burners, grates, oven vent openings and surfaces near these openings, oven doors, windows of oven doors, and crevices around the oven doors.
- Top burner flame size should be adjusted so it does not extend beyond the edge of the cooking utensil.
- Have the installer show you the location of the range gas shut-off valve and how to turn it off if necessary.

READ AND SAVE THESE INSTRUCTIONS

IMPORTANT SAFETY INSTRUCTIONS

- Proper Disposal of Your Appliance – Dispose of or recycle your appliance in accordance with Federal and Local Regulations. Contact your local authorities for the environmentally safe disposal or recycling of your appliance.
- Do Not Clean Door Gasket – The door gasket is essential for a good seal. Care should be taken not to rub, damage, or move the gasket.
- Do Not Use Oven Cleaners – No commercial oven cleaner or oven liner protective coating of any kind should be used in or around any part of the oven.
- Clean Only Parts Listed in Manual.

For units with ventilating hood –

- Clean Ventilating Hoods Frequently – Grease should not be allowed to accumulate on hood or filter.
- When flambé cooking under the vent hood, turn the fan on.

For self-cleaning ranges –

- Before Self-Cleaning the Oven – Remove broiler pan and other utensils. Wipe off all excessive spillage before initiating the cleaning cycle.
- Wait for the oven to cool before removing contents and cleaning the oven.
- In the event of ignition inside the oven during self-clean, turn off the oven and wait for the fire to extinguish. **DO NOT FORCE THE DOOR OPEN.**
- If the self-cleaning mode malfunctions, keep door closed, turn off the appliance, disconnect the circuit at the circuit breaker box, and contact a qualified service provider for repairs.
- Some birds are extremely sensitive to the fumes produced during a self-clean cycle. Move birds to another well-ventilated room.

READ AND SAVE THESE INSTRUCTIONS

OVERVIEW

RANGE LAYOUT

The range you have purchased may have some or all of the items listed. The locations and appearances of the features shown here may not match those of your model.

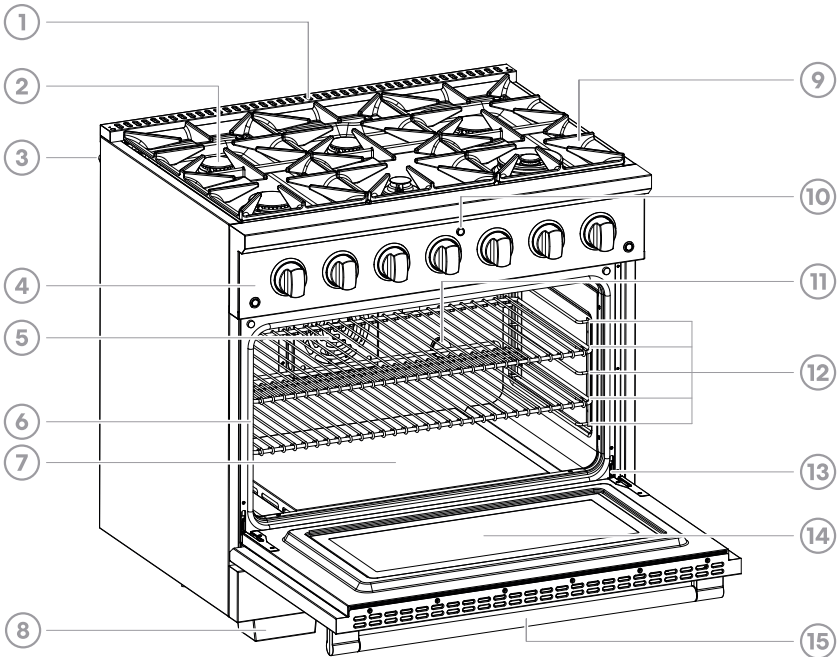

- 1. Oven Vent
- 2. Surface Burner
- 3. Rear Rubber Pad
- 4. Control Panel
- 5. Convection Fan

- 6. Door Gasket
- 7. Bake Burner Cover
- 8. Leveling Leg Cover
- 9. Grate
- 10. Oven Indicator Light

- 11. Oven Light
- 12. Rack Positions
- 13. Door Hinge
- 14. Oven Door Window
- 15. Oven Door Handle

WHAT'S INCLUDED

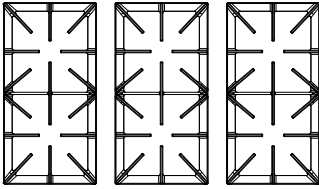

Surface burner grates
30" Model: COS-GRP304 (3)
36" Model: COS-GRP366 (3)
48" Model: COS-GRP486G (4)

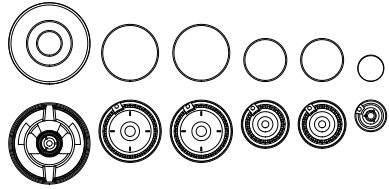

Surface burners and caps
30" Model: COS-GRP304 (4)
36" Model: COS-GRP366 (6)
48" Model: COS-GRP486G (8)

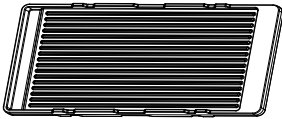

Griddle
48" Model: COS-GRP486G

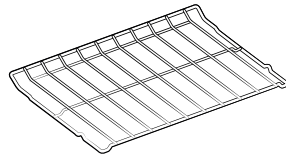

Oven racks (2)

OPTIONAL PARTS

- Stylish color handle & knob kits



Scan to find
available
handle & knob
kits

NOTE:

- To purchase these or any other accessories or replacement parts, please visit www.cosmoappliances.com or reference the contact information at the end of this manual.

CONTROL PANEL

COS-GRP304 (30")

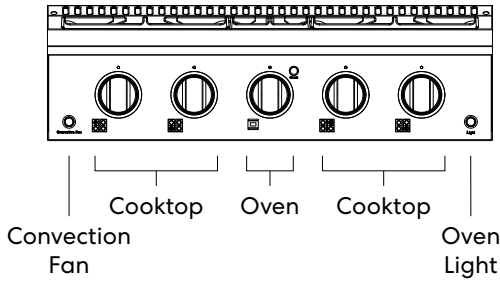

COS-GRP366 (36")

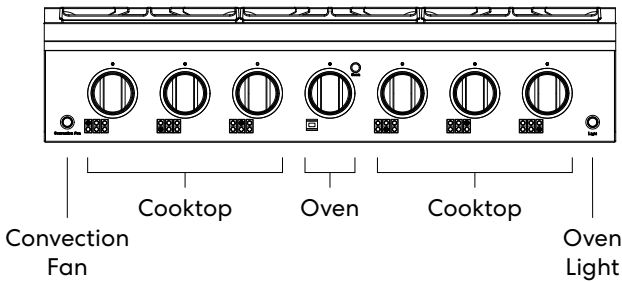

COS-GRP486G (48")

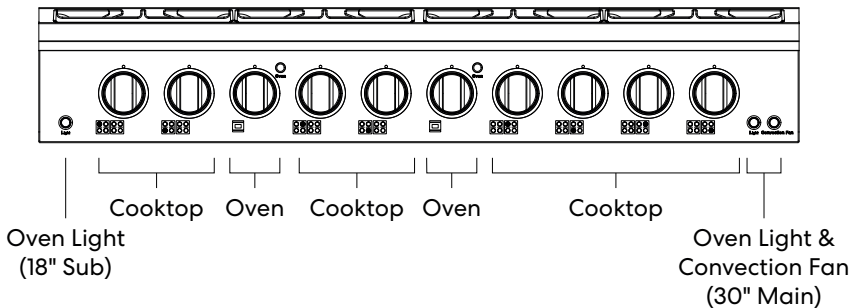

FEATURES

CONVECTION FAN

The convection fan increases air movement and circulates heat within the oven to improve heat distribution on multiple racks and enhance cooking evenness while cooking with single or multiple racks. Cooking times may be slightly longer for multiple racks than what would be expected for a single rack.

- Press **Convection Fan** to turn the oven convection fan on or off.

NOTE:

- The convection fan turns on for Bake mode only.

LIGHT

The oven lights automatically turn on when the door is opened and turn off when the door is closed.

- Press **Light** to manually turn the oven lights on or off.

OVEN INDICATOR LIGHT

The oven indicator light automatically turns on when the oven is heating. The oven burner cycles on and off to maintain the set temperature. When the set temperature is reached, the oven indicator light will temporarily turn off until the heating cycle is activated to maintain the set temperature.

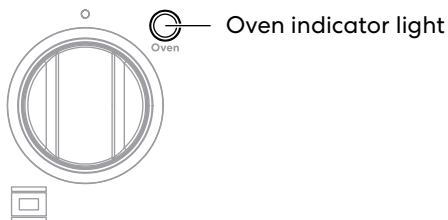

OPERATION

GAS SURFACE BURNERS

BEFORE USING THE GAS SURFACE BURNERS

Read all instructions before using.

WARNING

- Make sure all burners are in their correct locations and fully assembled before attempting to operate any burner.
- Never leave the surface burners on unattended. Boilovers may cause smoke and greasy spillovers that may ignite.
- Do not use aluminum foil to line or cover the cooktop, grates, or any other part of the cooktop. Doing so may result in carbon monoxide poisoning, overheating of the cooktop surfaces, or fire.
- Use the proper pan size. Do not use pans that are unstable or that can be easily tipped. Select cookware with flat bottoms large enough to cover burner grates.
- To avoid spillovers, make sure the cookware is large enough to contain the food properly. This will both save cleaning time and prevent hazardous accumulations of food, since heavy spattering or spillovers left on the range can ignite.

CAUTION

- Control the top burner flame size so it does not extend beyond the edge of the cookware. Excessive flame is hazardous.
- Do not operate the burner for an extended period of time without cookware on the grate. The finish on the grate may discolor or chip without cookware to absorb the heat.
- Do not attempt to disassemble any burner while another burner is on. Damage to the product may occur.
- Be sure the burners and grates are cool before you place your hand, a pot holder or cleaning materials on them.

IMPORTANT:

- The use of a gas-cooking appliance results in the production of heat and moisture in the room in which it is installed. Ensure that the kitchen is well ventilated: keep natural ventilation holes open or install a mechanical ventilation device (mechanical extractor hood).
- Prolonged intensive use of the appliance may call for additional ventilation, for example opening of a window, or more effective ventilation, for example increasing the level of mechanical ventilation where present.

USING THE GAS SURFACE BURNERS

Lighting a Surface Burner

1. Select a burner and find its control knob.
2. Push the control knob in and turn it to the IGNITE position. The electric spark ignition system will make a clicking noise.

NOTE:

- When one burner is turned to IGNITE, all burners will spark. Sparking will continue as long as the knob remains at IGNITE.
- For **COS-GRP486G (48")** only:
When one burner on the left or the right side is turned to IGNITE, the other 3 burners on the same side will spark.

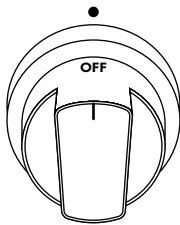

OFF position

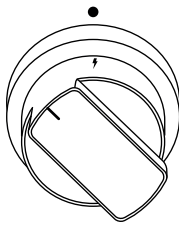

IGNITE position

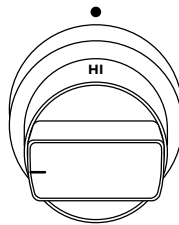

HI position

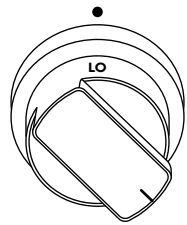

LO position

Selecting a Flame Size

Watch the flame, not the control knob, as you reduce heat. Match the flame size on a gas burner to the cookware being used for fastest heating.

NOTE:

- Never let the flames extend up the sides of the cookware. Flames larger than the bottom of the cookware will not heat faster and may be hazardous.

In Case of Power Failure

In case of a power failure, you can light the gas surface burners on your range with a match. Surface burners in use when an electrical power failure occurs will continue to operate normally.

1. Using extreme caution, hold a lit match to the burner
2. Push in the control knob, then turn the control knob to the Lo position.
3. Once gas is ignited, turn the control knob to adjust the flame size.

USING THE PROPER COOKWARE

Aluminum

Medium-weight cookware is recommended because it heats quickly and evenly. Most foods brown evenly in an aluminum skillet. Use saucapans with tight fitting lids when cooking with minimum amounts of water.

Cast-Iron

If heated slowly, most skillets will give satisfactory results.

Stainless Steel

This metal alone has poor heating properties and is usually combined with copper, aluminum or other metals for improved heat distribution. Combination metal skillets work satisfactorily if they are used with medium heat as the manufacturer recommends.

Enamelware

Under some conditions, the enamel of this cookware may melt. Follow cookware manufacturer's recommendations for cooking methods.

Glass

There are two types of glass cookware. Those for oven use only and those for top-of-range cooking.

Heatproof Glass Ceramic

Can be used for either surface or oven cooking. It conducts heat very slowly and cools very slowly. Check cookware manufacturer's directions to be sure it can be used on gas ranges.

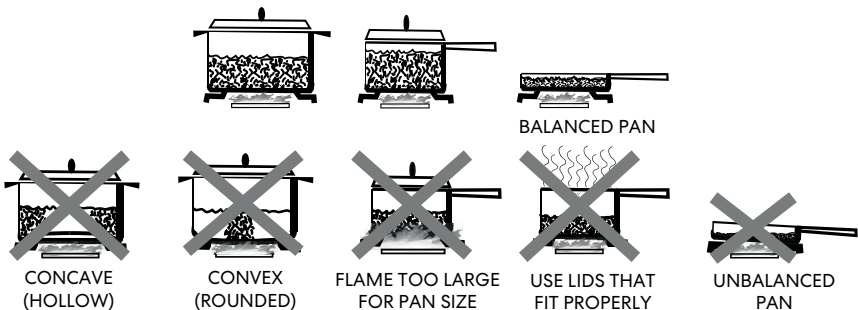

NOTE:

- The flame should not extend beyond the bottom edge of the cookware. Oversized cookware that spans two burners should be placed front to rear, not side to side.
- Use balanced cookware that sits level on the cooktop grate without rocking. Center the cookware over the burner.
- Use a lid that fits properly. A well-fitting lid helps shorten the cooking time.
- Match the size of the cookware to the amount of food being cooked to save energy when heating.
- Do not use stove top grills on the surface burners. Using a stove top grill on the surface burner will cause incomplete combustion and can result in exposure to carbon monoxide levels above allowable current standards. This can be a health hazard.
- If using a wok, use only a flat-bottomed wok with diameter of 14 inches or less. Make sure that the wok bottom sits flat on the grate.
- Do not use a wok support ring. Placing the ring over the burner or grate may cause the burner to work improperly, resulting in carbon monoxide levels above allowable standards. This can be hazardous to your health.

OVEN

BEFORE USING THE OVEN

Read all instructions before using.

CAUTION

- Do not use any type of foil or oven liner to cover the oven bottom. These items can trap heat or melt, resulting in damage to the product and risk of shock, smoke or fire. Damage from improper use of these items is not covered by the product warranty.
- Foil may be used to catch spills by placing a sheet on a lower rack, several inches below the food. Do not use more foil than necessary and never entirely cover an oven rack with aluminum foil. Keep foil at least 1-1/2" (3.8 cm) from oven walls to prevent poor heat circulation.
- Do not block, touch or place items around the oven vent during cooking. Your oven is vented through ducts at the center above the burner grate. Do not block the oven vent when cooking to allow for proper air flow.
- In case of power failure, do not use the oven. The oven and broiler cannot be used during a power outage. If the oven is in use when a power failure occurs, the oven burner shuts off and cannot be re-lit until power is restored. Once power is restored, you will need to reset the oven cooking mode.
- Do not attempt to operate the electric ignition during an electrical power failure.
- As the oven heats up, the heated air in the oven may cause condensation to appear on the oven door glass. These water drops are harmless and will evaporate as the oven continues to heat up.
- An air curtain or other overhead range hood, which operates by blowing a downward airflow onto a range shall not be used in conjunction with a gas range.

BEFORE USING THE OVEN FOR THE FIRST TIME

Start the oven in BAKE mode at the highest available temperature setting. Allow oven to run for 1 hour to remove any dust or impurities. There will be a distinctive odor - this is normal. Ensure your kitchen is well ventilated during this conditioning period.

OVEN VENT

Areas near the vent may become hot during operation and may cause burns. Avoid placing plastics near the vent as heat may distort or melt the plastic.

Do not block the vents (air openings) of the range. They provide the air inlet and outlet that are necessary for the range to keep cool and operate properly with correct combustion.

It is normal for steam to be visible when cooking foods with high moisture content.

USING OVEN RACKS

CAUTION

- Replace oven racks before turning the oven on to prevent burns.
- Do not cover the racks with aluminum foil, or any other material, or place anything on the bottom of the oven. Doing so will result in poor baking and may damage the oven bottom.
- Only arrange oven racks when the oven is cool.

Removing Racks

1. Pull the rack straight out until it stops.
2. Lift up the front of the rack and pull it out.

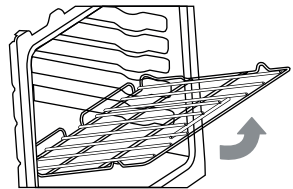

Replacing Racks

1. Place the end of the rack on the support.
2. Tilt the front end up and push the rack in.

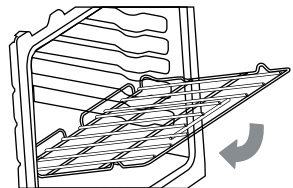

Rack Positions

For best cooking results, adjust rack so food is placed at the center of the oven. For most foods this will be rack position #2 or #3. For larger foods like roasts and turkey, move the rack position down to #1 or #2 to keep the food centered in the oven.

When using multiple racks simultaneously, try to space the food out around the oven center (rack position #1 and #3 or #2 and #4 for two racks).

Broiling performs best with the food close to the broil burner - typically rack position #4 or #5.

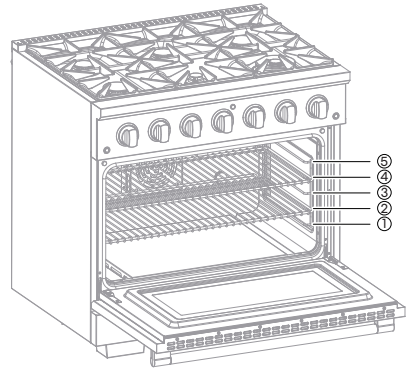

PREHEATING

Preheating is generally desirable, although not absolutely necessary in all circumstances. Some foods are more robust and may have acceptable results without preheating. These foods include large pieces of meat (whole roasts, hams, or poultry) where the total cooking time is much longer than the time required to preheat. These foods also include frozen potato products and frozen processed dinners that, by their nature and design, are more robust to baking variations. More delicate foods, such as breads (including cakes, cookies, pastries, and pizzas), desserts, soufflés, etc. will likely not have acceptable results without proper preheating.

OVEN CONTROLS

The appearance of the knob may vary from what is shown in the manual.

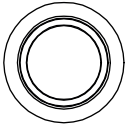

Convection Fan

Convection fan button

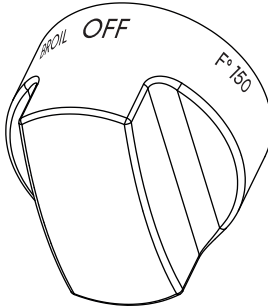

Thermostat knob (°F)

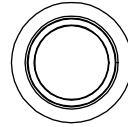

Light

Light button

Thermostat Knob

The Thermostat knob is used to select oven cooking modes.

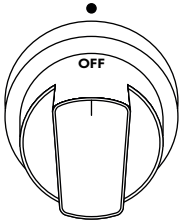

OFF position

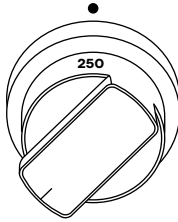

BAKE (250°F)
position

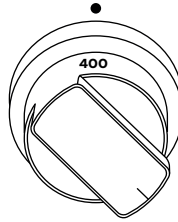

BAKE (400°F)
position

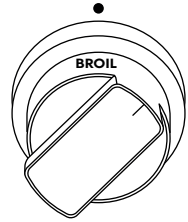

BROIL position

Convection Fan

- Push the Convection Fan button to turn the convection fan On or Off.

Light

- Push the Light button to turn the oven lights On or Off.

BAKE

The Bake mode uses heat from the lower heating element to cook food. This mode works best with food placed on a single rack. When using this mode to prepare baked goods such as cakes, cookies and pastries, always preheat the oven first and place food centrally near the middle or lower racks.

Setting the Bake Mode (Example: Set Bake at 375°F.)

1. Adjust oven rack levels as needed.
2. Turn the thermostat knob to select **375°F**. The oven turns on and starts preheating.

NOTE:

- Once the oven reaches the set temperature, the oven pauses heating and the oven indicator light turns off temporarily. The oven heating cycle will automatically resume to maintain the set temperature, and the oven indicator light will turn on again.

3. Place the food in the oven after preheating.
4. Turn the thermostat knob to the **OFF** position when cooking is finished, and remove the food from the oven.

NOTE:

- Baking time and temperature will vary depending on the characteristics, size, and shape of the baking pan used.
- Check for food doneness at the minimum recipe time.
- Use metal bakeware (with or without a nonstick finish), heatproof glass-ceramic, ceramic or other bakeware recommended for oven use.
- Dark metal pans or nonstick coatings will cook food faster with more browning. Insulated bakeware will slightly lengthen the cooking time for most foods.

BROIL

The Broil mode uses intense heat from the upper heating element to sear foods. This mode works best for tender cuts of meat, fish, and thinly cut vegetables, and is ideal for toasting, melting cheese, browning and searing surface. Food should be placed near the upper racks, and should not be cooked for too long on each side of the food. Preheat the oven for about 5 minutes before placing food in the oven.

Setting the Broil Mode

1. Adjust oven rack levels as needed and place the food in the oven.
2. Turn the thermostat knob to select **BROIL**. The oven turns on and starts preheating.
3. Place the food in the oven after preheating for about 5 minutes.
4. Turn the thermostat knob to the **OFF** position when cooking is finished, and remove the food from the oven.

NOTE:

- The broil burner is very powerful. Follow recipe directions and monitor food closely to reduce risk of burning food.
- Always use a broiler pan and grid for excess fat and grease drainage. This will help to reduce splatter, smoke, and flare-ups.
- Do not use a broiler pan without a grid. Oil can cause a grease fire.
- Do not cover the grid and broiler pan with aluminum foil. Doing so will cause a fire.

CONVECTION BAKE

The Convection Bake mode uses heat from the lower heating element and hot air movement from the convection fan to enhance cooking efficiency and evenness across multiple racks. Always preheat the oven first. Baking times may be slightly longer for multiple racks than what would be expected for a single rack.

Setting the Convection Bake Mode (Example: Set Convection Bake at 375°F.)

1. Adjust oven rack levels as needed.
2. Turn the thermostat knob to select **375°F**, and press the **Convection Fan** button. The oven turns on and starts preheating.

NOTE:

- Once the oven reaches the set temperature, the oven pauses heating and the oven indicator light turns off temporarily. The oven heating cycle will automatically resume to maintain the set temperature, and the oven indicator light will turn on again.

3. Place the food in the oven after preheating.
4. Press the **Convection Fan** button and turn the thermostat knob to the **OFF** position when cooking is finished, and remove the food from the oven

NOTE:

- The oven fan runs while convection baking.
- Use Convection Bake for faster and more even multiple-rack cooking of pastries, cookies, muffins, biscuits, and breads of all kinds.
- Place the oven racks in positions suggested in the "Tips and Techniques" section.
- Bake cookies and biscuits on pans with no sides or very low sides to allow heated air to circulate around the food. Food baked on pans with a dark finish will cook faster.

TIPS AND TECHNIQUES

BAKE

Baking is cooking with heated air. The lower heating element in the oven is used to heat the air but no fan is used to circulate the heat.

Follow the recipe or convenience food directions for baking temperature, time and rack position. Baking time will vary with the temperature of ingredients and the size, shape and finish of the baking utensil.

- For best results, bake food on a single rack with at least 1" - 1½" (2.5 - 3 cm) space between utensils and oven walls.
- Use one rack when selecting the bake mode.
- Check for doneness at the minimum time.
- Use metal bakeware (with or without a non-stick finish), heatproof glass, glass-ceramic, pottery or other utensils suitable for the oven.
- When using heatproof glass, reduce temperature by 25°F (15°C) from recommended temperature.
- Use baking sheets with or without sides or jelly roll pans.
- Dark metal pans or nonstick coatings will cook faster with more browning. Insulated bakeware will slightly lengthen the cooking time for most foods.
- Do not use aluminum foil or disposable aluminum trays to line any part of the oven. Foil is an excellent heat insulator and heat will be trapped beneath it. This will alter the cooking performance and can damage the finish of the oven.

BROIL

The Broil mode uses intense heat from the upper heating element to sear foods. The size, weight, thickness, starting temperature, and your preference of doneness will affect broiling times.

- For best results when broiling, use a broiler pan and grid designed for broiling.
- For proper draining, do not cover the grid with foil. The bottom of the pan may be lined with aluminum foil for easier cleaning.
- Trim excess fat to reduce spattering. Slit the remaining fat on the edges to avoid curling.
- Preheat the oven for about 5 minutes before placing food in the oven.

CONVECTION BAKE

The convection fan increases air movement and circulates heat within the oven to improve heat distribution on multiple racks and enhance cooking evenness while cooking with single or multiple racks. Reduce recipe baking temperatures by 25°F (15°C). Cooking times may be slightly longer for multiple racks than what would be expected for a single rack.

- For best results, foods should be cooked uncovered, in low-sided pans to take advantage of the forced air circulation. Use shiny aluminum pans for best results unless otherwise specified.
- Heatproof glass or ceramic can be used. Reduce temperature by another 25°F (15°C) when using heatproof glass dishes for a total reduction of 50°F (30°C).
- Dark metal pans may be used. Note that food may brown faster when using dark metal bakeware.
- The number of racks used is determined by the height of the food to be cooked.
- Baked items, for the most part, cook extremely well in convection. Don't try to convert recipes such as custards, quiches, pumpkin pie, or cheesecakes, which do not benefit from the convection-heating process. Use the regular Bake mode for these foods.
- Multiple rack cooking for oven meals is mostly done on rack positions 1, 2, 3, and 4. All four racks can be used for cookies, biscuits and appetizers.
 - 2 Rack baking: Use positions 2 and 4 or 1 and 3.
 - 3 rack baking: Use positions 1, 3 and 5 or 2, 3 and 4.
 - When baking four cake layers at the same time, stagger pans so that one pan is not directly above another. For best results, place cakes on front of one rack and back of another rack (See graphic at right). Allow 1" - 1 ½" (2.5 - 3 cm) air space around pans.

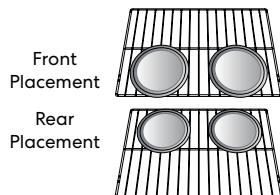
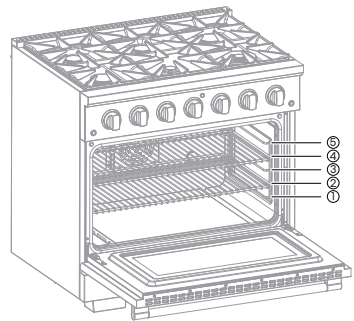

- Converting your own recipe can be easy. Choose a recipe that will work well in convection.
- Reduce the temperature and cooking time if necessary. It may take some trial and error to achieve a perfect result. Keep track of your technique for the next time you want to prepare the recipe using convection.

RANGE CARE AND MAINTENANCE

CLEANING

IMPORTANT: Before cleaning, make sure all controls are off and the oven and cooktop are cool. Always follow label instructions on cleaning products. Soap, water and a soft cloth or sponge are suggested first unless otherwise noted. Do not use abrasive cleaning products.

NOTE:

- Do not clean the oven door gasket. The material of the gasket cannot withstand abrasion. It is essential for the gasket to remain intact. If you notice it becoming worn or frayed, replace it.

EXTERIOR PORCELAIN ENAMEL SURFACES

- Food spills containing acids, such as vinegar and tomato, should be cleaned as soon as the entire appliance is cool. These spills may affect the finish.

Cleaning Method:

- Glass cleaner, mild liquid cleaner or nonabrasive scrubbing pad: Gently clean around the model and serial number plate because scrubbing may remove numbers.

EXTERIOR STAINLESS STEEL

- Rub in direction of grain to avoid damaging.

Cleaning Methods:

- Liquid detergent or all-purpose cleaner: Rinse well with clean water and dry with soft, lint-free cloth.
- Stainless Steel Cleaner and Polish. Vinegar for hard water spots.

NOTE:

- Do not use soap-filled scouring pads, abrasive cleaners, Cooktop Polishing Cream, steel-wool pads, gritty washcloths or some paper towels. Damage may occur, even with one-time or limited use.

OVEN DOOR EXTERIOR

Cleaning Method:

- Glass cleaner and paper towels or nonabrasive plastic scrubbing pad: Apply glass cleaner to soft cloth or sponge, not directly on panel.

PORCELAIN-COATED GRATES AND CAPS

- Clean as soon as cooktop, grates and caps are cool.
- Food spills containing acids, such as vinegar and tomato, should be cleaned as soon as the cooktop grates and caps are cool. These spills may affect the finish.
- To avoid chipping, do not bang grates and caps against each other or hard surfaces such as cast iron cookware.
- Do not reassemble caps on burners while wet.

Cleaning Method:

- Nonabrasive plastic scrubbing pad and mildly abrasive cleanser.

BURNER BASE/SPREADER

Cleaning Method:

- Wash the burner base/spreader frequently with boiling water and detergent to remove any deposits which could block the flame outlet.
- Before reinstalling, dry the burner base/spreader thoroughly so the burner will ignite properly.

COOKTOP CONTROL KNOBS

- Pull knobs straight away from control panel to remove.
- When replacing knobs, make sure knobs are in the OFF position.

Cleaning Method:

- Soap and water or dishwasher.

NOTE:

- Do not use steel wool, abrasive cleansers or oven cleaner. Do not soak knobs.

CONTROL PANEL

Cleaning Method:

- Glass cleaner and soft cloth or sponge: Apply glass cleaner to soft cloth or sponge, not directly on panel.

NOTE:

- Do not use abrasive cleaners, steel-wool pads, gritty washcloths or some paper towels. Damage may occur.

OVEN CAVITY

- Food spills should be cleaned when oven cools. At high temperatures, foods react with porcelain, so staining, etching, pitting or faint white spots can result.

Cleaning Method:

- Mild detergent and warm water.

NOTE:

- Do not use oven cleaners.

OVEN RACKS AND ROASTING RACKS

Cleaning Method:

- Steel-wool pad

2-PIECE BAKING TRAY OR BROILER PAN

Cleaning Method:

- Mildly abrasive cleanser: Scrub with wet scouring pad.
- Solution of ½ cup (125 mL) ammonia to 1 gal. (3.75 L) water: Soak for 20 minutes, and then scrub with scouring or steel-wool pad.
- Oven cleaner: Follow product label instructions.

Porcelain enamel only, not chrome

- Dishwasher

TROUBLESHOOTING

First try the solutions suggested here to possibly avoid the cost of a service call.

COOKTOP PROBLEMS

PROBLEM	POSSIBLE CAUSE	SOLUTION
Burner will not ignite	There is no power to the range.	Make sure electrical plug is plugged into a live, properly grounded outlet. Replace the fuse or reset the circuit breaker.
Burner will not operate	First time use. Air still in the gas line.	Turn on any one of the surface burner knobs to release air from the gas lines.
	Control knob is not set correctly.	Push in knob before turning to a setting.
	The burner port is clogged.	Clean burner port opening using a stiff, nylon toothbrush or a straightened paper clip.
Excessive heat around cookware on cooktop	The cookware is not the proper size for the burner.	Use cookware with a bottom surface approximately the same size as the cooking area and burner. Cookware should not extend more than 1" (2.5 cm) outside the cooking area. Adjust the flame so that it does not come up around the cookware.
Burner Flames are uneven, yellow and/or noisy	Burner port(s) are clogged.	Clean burner port opening using a stiff, nylon toothbrush or a straightened paper clip.
	Burner caps are not positioned properly.	Place burner caps so that the alignment pins are properly aligned with the slots.
	Propane gas is being used.	The range should be converted to LP gas by a qualified technician.

PROBLEM	POSSIBLE CAUSE	SOLUTION
Burner flame is too high or too low	Cooktop gas supply is not correct.	Ensure the range is set for the correct gas type. It is factory set for natural gas. If connecting to LP gas, the burners should be converted to LP gas with the orifice kit supplied and the pressure regulator converted to the LP gas setting by a qualified technician.
	The gas pressure is not correct.	Make sure the pressure regulator is installed correctly and the gas line pressure is correct. See Installation Instructions.
Burner makes popping noises	The burner is wet.	Allow the burner to dry before using.
	The burner cap or gas spreader is not positioned correctly.	Place burner caps so that the alignment pins are properly aligned with the slots.
Cooking results are not what expected	Using incorrect cookware.	See the "Using The Proper Cookware" section.
	The control knob is not set to the proper heat level.	See the "Using The Gas Surface Burners" section.
Unable to maintain a rolling boil or will not cook fast enough	Using improper cookware.	Use pans with flat bottoms and that match the diameter of the cooktop burner selected. Adjust flame so that flame does not extend beyond edge of pot. See the "Using The Proper Cookware" section.
	Using large cookware without lid.	Large pots and pans can lose a lot of heat from the top. Cover pot or pan with a lid to retain heat better.

OVEN PROBLEMS

PROBLEM	POSSIBLE CAUSE	SOLUTION
Strong odor when using new oven	Manufacturing protective coating on the oven surfaces.	This is normal with a new range and will disappear after a few uses.
	Packaging materials exist.	Double-check that all packaging has been removed from the appliance - check around door sides and inside drawer.
Clicking noise can be heard when oven is operating	The oven burner cycles on and off to maintain the oven temperature selected.	When burner turns on, the electric spark ignition may be heard periodically. It is normal to spark for only a few seconds, followed by the sound of the burner igniting.
Oven is not heating	No power to the range.	Check the circuit breaker or fuse box to your house. Make sure there is proper electrical power to the oven.
	Oven control not turned on.	Make sure the oven temperature has been selected.
Oven is not cooking evenly	Not using the correct bakeware or oven rack position.	Refer to the "Using Oven Racks" section and the cook charts for recommended rack position. Always reduce recipe temperature by 25°F (15°C) when baking with Convention Bake mode. Recipe may perform better at a different rack position. Try moving the food down a rack position to make the bottom darker. Try moving food up a rack position to make the top darker.
Cooling fan continues to run after oven is turned off	The electronic components have not yet cooled sufficiently.	The fan will turn off automatically when the electronic components have cooled sufficiently.

PROBLEM	POSSIBLE CAUSE	SOLUTION
Oven light is not working properly	Light bulb loose or burned-out.	Reinsert or replace the light bulb. Touching the bulb with fingers may cause the bulb to burn out.
Oven light stays on	Door is not closing completely	Check for obstruction in oven door. Check to see if hinge is bent or door switch broken.
Excessive Moisture on door glass	Condensation from cooking foods with high moisture content.	This is normal. Condensation will evaporate as oven heats up. Convection Bake and Convection Roast will eliminate any moisture in the oven.
Porcelain Chips	Porcelain interior is chipped by oven racks	When removing and replacing oven racks, always tilt racks upward and do not force them to avoid chipping the porcelain.

BAKING PROBLEMS

With any oven setting poor results can occur for many reasons other than a malfunction of the oven. Check the chart below for causes of the most common problems. Since the size, shape and material of baking utensils directly affect the baking results, the best solution may be to replace old baking utensils that have darkened and warped with age and use.

PROBLEM	CAUSE
Food browns unevenly	<ul style="list-style-type: none"> • Oven not preheated • Aluminum foil on oven rack or oven bottom • Baking utensil too large for recipe • Pans touching each other or oven walls
Food too brown on bottom	<ul style="list-style-type: none"> • Oven not preheated • Using glass, dull or darkened metal pans • Incorrect rack position • Pans touching each other or oven walls

PROBLEM	CAUSE
Food is dry or has shrunk excessively	<ul style="list-style-type: none"> • Oven temperature too high • Baking time too long • Oven door opened frequently • Pan size too large
Food is baking or roasting too slowly	<ul style="list-style-type: none"> • Oven temperature too low • Oven not preheated • Oven door opened frequently • Tightly sealed with aluminum foil • Pan size too small
Pie crusts do not brown on bottom or crust is soggy	<ul style="list-style-type: none"> • Baking time not long enough • Using shiny steel pans • Incorrect rack position • Oven temperature is too low
Cakes pale, flat and may not be done inside	<ul style="list-style-type: none"> • Oven temperature too low • Incorrect baking time • Cake tested too soon • Oven door opened too often • Pan size may be too large
Cakes high in middle with crack on top	<ul style="list-style-type: none"> • Oven temperature too high • Baking time too long • Pans touching each other or oven walls • Incorrect rack position • Pan size too small
Pie crust edges too brown	<ul style="list-style-type: none"> • Oven temperature too high • Edges of crust too thin

LIMITED WARRANTY

WARRANTY AND SERVICE

TO RECEIVE WARRANTY SERVICE, YOUR PRODUCT MUST BE REGISTERED.

TO REGISTER AND REVIEW FULL WARRANTY DETAILS, VISIT:

WWW.COSMOAPPLIANCES.COM/WARRANTY

SCAN TO REGISTER



CUSTOMER SUPPORT

TO CHAT WITH US LIVE FOR ASSISTANCE, VISIT:

WWW.COSMOAPPLIANCES.COM/CHAT

SCAN TO CHAT



IMPORTANT

Do Not Return This Product To The Store

If you have a problem with this product, please contact COSMO Customer Support at

+1 (888) 784-3108

DATED PROOF OF PURCHASE, MODEL #, AND SERIAL # REQUIRED FOR WARRANTY SERVICE.

IMPORTANT

Ne pas Réexpédier ce Produit au Magasin

Pour tout problème concernant ce produit, veuillez contacter le service des consommateurs Cosmo Customer Support au

+1 (888) 784-3108

UNE PREUVE D'ACHAT DATEE EST REQUISE POUR BENEFICIER DE LA GARANTIE.

IMPORTANTE

No regrese este producto a la tienda

Si tiene algún problema con este producto, por favor contacte el ayuda al cliente COSMO al

+1 (888) 784-3108

(Válido solo en E.U.A.)

NECESITA UNA PRUEBA DE DE COMPRA FECHADA, NÚMERO DE MODELO Y DE SERIE PARA EL SERVICIO DE LA GARANTÍA.



Correct disposal of this product:

This marking indicates that this appliance should not be disposed with other household wastes. To prevent possible harm to the environment or human health from uncontrolled waste disposal, recycle it responsibly to promote the sustainable reuse of material resources.

MEMO

A series of horizontal dashed lines for writing.



APPLIANCES

Cosmo is constantly making efforts to improve the quality and performance of our products, so we may make changes to our appliances without updating this manual.

Electronic version of this manual is available at:
www.cosmoappliances.com