

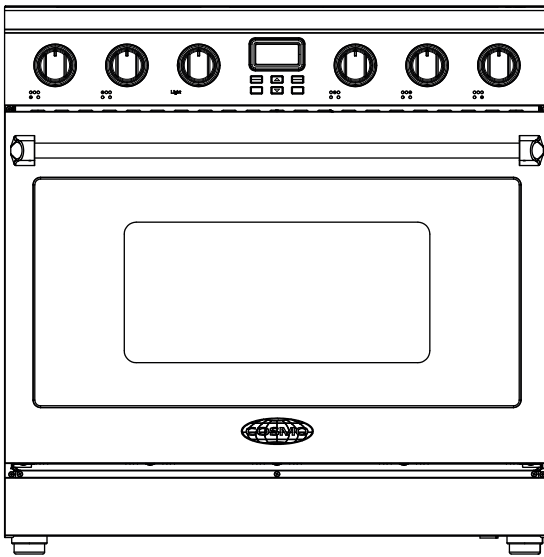

# ELECTRIC RANGE

## COS-ERC365KBD



## 36-in SLIDE-IN RANGE

### USER MANUAL

**IMPORTANT:** READ AND SAVE THESE INSTRUCTIONS.  
FOR RESIDENTIAL USE ONLY.

**INSTALLER:** PLEASE LEAVE THESE INSTRUCTIONS WITH THIS UNIT FOR  
THE OWNER.

**OWNER:** PLEASE RETAIN THESE INSTRUCTIONS FOR FUTURE  
REFERENCE.

# THANK YOU FOR YOUR PURCHASE

**Thank you for your purchase. We know that you have many brands and products to choose from and we are honored to know that you have decided to take one of our products into your home and hope that you enjoy it.**

COSMO Appliances are designed according to the strictest safety and performance standard for the North American market. We follow the most advanced manufacturing philosophy. Each appliance leaves the factory after thorough quality inspection and testing. Our distributors and our service partners are ready to answer any questions you may have regarding how to install, use and care for your products. We hope that this manual will help you learn to use the product in the safest and most effective manner.

**Before using this product, please read through this manual carefully.** Keep this user manual in a safe place for future reference. Please ensure that other persons using this product are familiar with these instructions as well.

If you have any questions or concerns, please contact the dealer from whom you purchased the product, or contact our Customer Support at:

**1-888-784-3108**

Reach us online at:

**[www.cosmoappliances.com](http://www.cosmoappliances.com)**

# TABLE OF CONTENTS

<b>RANGE SAFETY .....</b>	<b>5</b>
Anti-tip Device .....	6
Important Safety Instructions.....	7
<b>OVERVIEW .....</b>	<b>12</b>
Range Layout.....	12
Control Panel.....	14
<b>FEATURES.....</b>	<b>15</b>
Clock.....	15
Timer .....	16
Settings .....	17
Setting Clock.....	18
Setting Temperature Scale.....	18
Turning On/Off Control Button Sound.....	18
Displaying System Error Code Record.....	18
Setting Oven Temperature Calibration .....	19
Displaying System Firmware Version .....	19
Turning On/Off Demo Mode .....	19
Resetting All Settings .....	20
Oven Light .....	20
<b>OPERATION .....</b>	<b>21</b>
Cooktop.....	21
Before Using the Cooktop .....	21
Cooking Areas .....	23
Hot Surface Indicator.....	23
Using the Cooktop Elements.....	24
Using the Proper Cookware .....	25
Oven.....	27
Before Using the Oven.....	27
Before Using the Oven for the First Time.....	28
Oven Vent .....	28
Oven Door.....	28

Using Oven Racks.....	29
Preheating.....	30
Cooking Modes.....	31
Bake.....	32
Conv Bake.....	33
Conv Roast.....	35
Pizza.....	36
Warm.....	38
Broil.....	39
Tips and Techniques.....	40
<b>RANGE CARE AND MAINTENANCE.....</b>	<b>47</b>
Cleaning.....	47
<b>TROUBLESHOOTING.....</b>	<b>53</b>
Cooktop Problems.....	53
Oven Problems.....	55
<b>LIMITED WARRANTY.....</b>	<b>58</b>

# RANGE SAFETY

## READ ALL INSTRUCTIONS BEFORE USING THE APPLIANCE

**Your safety and the safety of others are very important.**

We have provided many important safety messages in this manual and on your appliance. Always read and obey all safety messages.



This is the safety alert symbol.

This symbol alerts you to potential hazards that can kill or hurt you and others.

All safety messages will follow the safety alert symbol and either the word "WARNING" or "CAUTION." These words mean:



You can be killed or seriously injured if you don't follow instructions.



A potentially hazardous situation which, if not avoided, could result in minor or moderate injury.

All safety messages will tell you what the potential hazard is, tell you how to reduce the chance of injury, and tell you what can happen if the instructions are not followed.

### California Proposition 65 Warning

 **WARNING:**

Cancer and Reproductive Harm - [www.P65Warnings.ca.gov](http://www.P65Warnings.ca.gov).

## **WARNING**



### **TIP OVER HAZARD**

- A child or adult can tip the range and be killed.
- Install anti-tip bracket to wall per installation instructions.
- Slide range back so rear range pin is engaged under the anti-tip bracket.
- Re-engage the anti-tip bracket if range is moved.
- Do not operate the range without anti-tip bracket installed and engaged.
- Failure to follow these instructions can result in death or serious burns to children and adults.

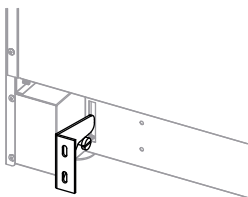

Making sure the anti-tip bracket is installed:

- Slide range forward.
- Look for the anti-tip bracket securely attached to wall.
- Slide range back and make sure the rear pin slides under the anti-tip bracket.

## **WARNING**

- This appliance is intended for normal residential use. It is not approved for commercial use, outdoor installation, or any other application not specifically allowed by this manual.
- This appliance requires connection to a 3-prong or 4-prong, 240VAC single-phase (split-phase), 60Hz grounded electrical source. When installed, appliance must be electrically grounded in accordance with local codes or, in the absence of local codes, with the National Electrical Code, NFPA 70 or the Canadian Electric Code, CSA C22.1-02.
- Proper installation is the responsibility of the installer. Any adjustment and service should be performed only by qualified range installers or service technicians.
- Product failure due to improper installation is not covered under warranty.

# IMPORTANT SAFETY INSTRUCTIONS

**WARNING:** To reduce the risk of fire, electrical shock, injury to persons, or damage when using the range, follow basic precautions, including the following:

- **WARNING:** TO REDUCE THE RISK OF TIPPING OF THE RANGE, THE RANGE MUST BE SECURED BY PROPERLY INSTALLED ANTI-TIP DEVICES. TO CHECK IF THE DEVICES ARE INSTALLED PROPERLY, SLIDE RANGE COMPLETELY FORWARD, LOOK FOR ANTI-TIP BRACKET SECURELY ATTACHED TO THE FLOOR OR WALL, AND SLIDE RANGE BACK SO THE REAR RANGE FOOT IS UNDER ANTI-TIP BRACKET.
- **CAUTION:** Do not store items of interest to children in cabinets above a range or on the back guard of a range – children climbing on the range to reach items could be seriously injured.
- Do Not Leave Children Alone – Children should not be left alone or unattended in area where range is in use. They should never be allowed to sit or stand on any part of the appliance.
- Never use your appliance for warming or heating the room.
- Use this appliance only for its intended purpose as described in this manual.
- Proper Installation – The appliance, when installed, must be electrically grounded in accordance with local codes, or in the absence of local codes, with the National Electrical Code, ANSI/NFPA 70 or the Canadian Electrical Code, CSA C22.1-02. In Canada, the appliance must be electrically grounded in accordance with Canadian Electrical Code. Be sure your appliance is properly installed and grounded by a qualified technician.
- User Servicing – Do not repair or replace any part of the range unless specifically recommended in the manual. All other servicing should be referred to a qualified technician.
- Before performing any service, unplug the range or disconnect the power supply at the household distribution panel by removing the fuse or switching off the circuit breaker.
- Do Not Use Water on Grease Fires – Smother fire or flame or use dry chemical or foam-type extinguisher.

**READ AND SAVE THESE INSTRUCTIONS**

# IMPORTANT SAFETY INSTRUCTIONS

- If there is a fire in the oven during baking, smother the fire by closing the oven door and turning the oven off or by using a multi-purpose dry chemical or foam-type fire extinguisher.
- Do not use any type of foil or liner to cover the oven bottom or anywhere in the oven, except as described in this manual. Oven liners can trap heat or melt, resulting in damage to the product and risk of shock, smoke or fire.
- Use Only Dry Potholders – Moist or damp potholders on hot surfaces may result in burns from steam. Do not let potholder touch hot heating elements. Do not use a towel or other bulky cloth.
- DO NOT TOUCH SURFACE UNITS OR AREAS NEAR UNITS – Surface units may be hot even though they are dark in color. Areas near surface units may become hot enough to cause burns. During and after use, do not touch, or let clothing or other flammable materials contact surface units or areas near units until they have had sufficient time to cool. Among these areas are the coil elements, the cooktop, and surfaces facing the cooktop.
- DO NOT TOUCH HEATING ELEMENTS OR INTERIOR SURFACES OF OVEN – Heating elements may be hot even though they are dark in color. Interior surfaces of an oven become hot enough to cause burns. During and after use, do not touch, or let clothing or other flammable materials contact heating elements or interior surfaces of oven until they have had sufficient time to cool. Other surfaces of the appliance may become hot enough to cause burns – among these surfaces are oven vent openings and surfaces near these openings, oven doors, and windows of oven doors.
- Do Not Cook on Broken Cooktop – If cooktop should break, cleaning solutions and spills may penetrate the broken cooktop and create a risk of electric shock. Contact a qualified technician immediately.
- Avoid scratching or impacting glass doors, cooktops, or control panels. The cooktop can be scratched with items such as knives, sharp instruments, rings or other jewelry, and rivets on clothing. Doing so may lead to glass breakage.

**READ AND SAVE THESE INSTRUCTIONS**



# IMPORTANT SAFETY INSTRUCTIONS

- Never Leave Surface Units Unattended at High Heat Settings – Boilover causes smoking and greasy spillovers that may ignite.
- Do Not Heat Unopened Food Containers – Build-up of pressure may cause container to burst and result in injury.
- Wear Proper Apparel – Loose-fitting or hanging garments should never be worn while using the appliance.
- Use Proper Pan Size – This appliance is equipped with one or more surface units of different size. Select utensils having flat bottoms large enough to cover the surface unit heating element. The use of undersized utensils will expose a portion of the heating element to direct contact and may result in ignition of clothing. Proper relationship of utensil to heating element will also improve efficiency.
- Glazed Cooking Utensils – Only certain types of glass, glass/ceramic, ceramic, earthenware, or other glazed utensils are suitable for range-top service without breaking due to the sudden change in temperature.
- Utensil Handles Should Be Turned Inward and Not Extend Over Adjacent Surface Units – To reduce the risk of burns, ignition of flammable materials, and spillage due to unintentional contact with the utensil, the handle of a utensil should be positioned so that it is turned inward, and does not extend over adjacent surface units.
- If power is lost to an electric cooktop with knob surface unit controls while a surface unit is ON, the surface unit will turn back on as soon as power is restored. In the event of power loss, failure to turn all surface unit knobs to the OFF position may result in ignition of items on or near the cooktop, leading to serious injury or death.
- Do not place or store items that can melt or catch fire on the glass cooktop, even when it is not being used. If the cooktop is inadvertently turned on, they may ignite. Heat from the cooktop or oven vent after it is turned off may cause them to ignite also.
- Use Care When Opening Door – Let hot air or steam escape before removing or replacing food.

**READ AND SAVE THESE INSTRUCTIONS**

# IMPORTANT SAFETY INSTRUCTIONS

- Never broil with door open. Open-door broiling is not permitted due to overheating of control knobs.
- Care must be taken to prevent aluminum foil and meat probes from contacting heating elements.
- Placement of Oven Racks – Always place oven racks in desired location while oven is cool. If rack must be moved while oven is hot, do not let potholder contact hot heating element in oven.
- Injuries may result from misuse of appliance doors or drawers such as stepping, leaning, or sitting on the doors or drawers.
- Storage in or on Appliance – Flammable materials should not be stored in an oven or near surface units.
- This appliance is not intended for storage.
- Maintenance – Keep range area clear and free from combustible materials, gasoline, and other flammable vapors and liquids.
- Do not let cooking grease or other flammable materials accumulate in or near the range. Grease in the oven or on the cooktop may ignite.
- Keep Oven Vent Ducts Unobstructed.
- Clean Cooktop With Caution – If a wet sponge or cloth is used to wipe spills on a hot cooking area, be careful to avoid steam burn. Some cleaners can produce noxious fumes if applied to a hot surface.
- Use care when touching the cooktop. The glass surface of the cooktop will retain heat after the controls have been turned off.
- Do Not Soak Removable Heating Elements – Heating elements should never be immersed in water.
- Do Not Clean Door Gasket – The door gasket is essential for a good seal. Care should be taken not to rub, damage, or move the gasket.
- Do Not Use Oven Cleaners – No commercial oven cleaner or oven liner protective coating of any kind should be used in or around any part of the oven.
- Clean Only Parts Listed in Manual.
- Do not use replacement parts that have not been recommended by the manufacturer (e.g. parts made at home using a 3D printer).

**READ AND SAVE THESE INSTRUCTIONS**

# IMPORTANT SAFETY INSTRUCTIONS

- Proper Disposal of Your Appliance – Dispose of or recycle your appliance in accordance with Federal and Local Regulations. Contact your local authorities for the environmentally safe disposal or recycling of your appliance.

## **For units with ventilating hood –**

- Clean Ventilating Hoods Frequently – Grease should not be allowed to accumulate on hood or filter.
- When flaming foods under the vent hood, turn the fan on.

## **For self-cleaning ranges –**

- Before Self-Cleaning the Oven – Remove broiler pan and other utensils. Wipe off all excessive spillage before initiating the cleaning cycle.

- Wait for the oven to cool before removing contents and cleaning the oven.
- In the event of ignition inside the oven during self-clean, turn off the oven and wait for the fire to extinguish. **DO NOT FORCE THE DOOR OPEN.** Introduction of fresh air at Self Clean temperatures may lead to a burst of flame from the oven.
- If the self-cleaning mode malfunctions, keep door closed, turn off the appliance, disconnect the circuit at the circuit breaker box, and contact a qualified service provider for repairs.
- Some birds are extremely sensitive to the fumes produced during a self-clean cycle. Move birds to another well-ventilated room.

**READ AND SAVE THESE INSTRUCTIONS**



# OVERVIEW

## RANGE LAYOUT

The range you have purchased may have some or all of the items listed. The locations and appearances of the features shown here may not match those of your model.

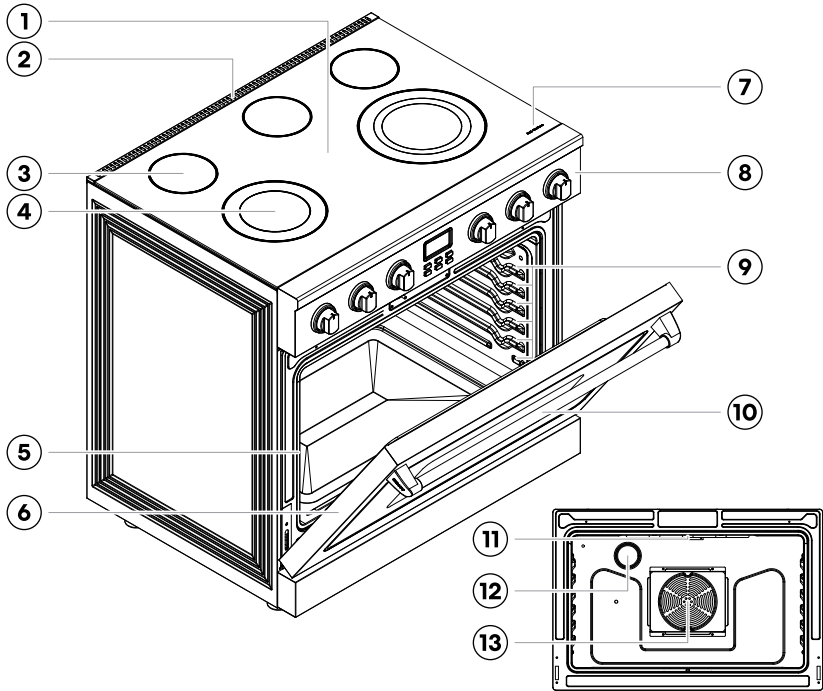

- |                                   |                                 |
|-----------------------------------|---------------------------------|
| 1. Glass-ceramic cooktop          | 7. Hot surface indicator        |
| 2. Oven vent                      | 8. Control panel                |
| 3. Single surface heating element | 9. Rack positions               |
| 4. Dual surface heating element   | 10. Oven door handle            |
| 5. Door gasket                    | 11. Upper broil heating element |
| 6. Oven door                      | 12. Oven light                  |
|                                   | 13. Convection fan              |

# WHAT'S INCLUDED

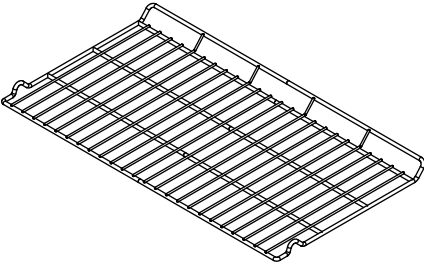

Oven racks (2)

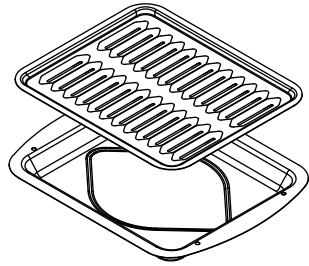

2-Piece broiler pan

**NOTE:**

- To purchase replacement parts or any other accessories, please visit [www.cosmoappliances.com](http://www.cosmoappliances.com) or reference the contact information at the end of this manual.

# CONTROL PANEL

The appearance of the knobs may vary from what is shown below.

## COS-ERC365KBD (36")

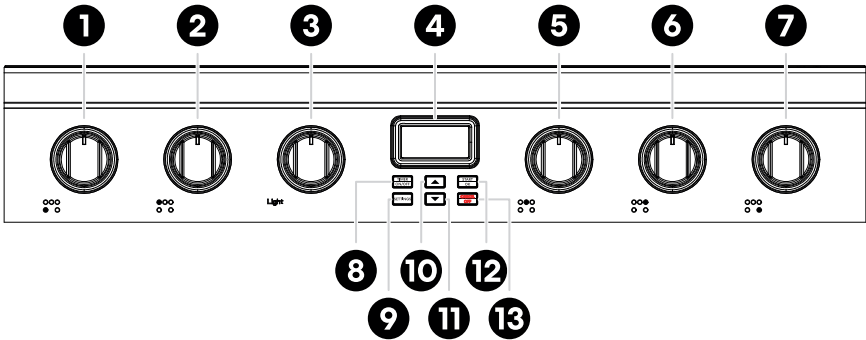

#	Name	Description
1	Cooktop element	To turn the front left dual-element on and off.
2	Cooktop element	To turn the rear left single-element on and off.
3	Light	To turn the oven light on and off.
4	Display	To show the time and provide oven status.
5	Cooktop element	To turn the rear middle single-element on and off.
6	Cooktop element	To turn the rear right single-element on and off.
7	Cooktop element	To turn the front right dual-element on and off.
8	Timer On/Off	To turn the timer on and off.
9	Settings	To access various oven settings.
10	Up	To select oven temperature, settings, and time.
11	Down	To select oven temperature, settings, and time.
12	Start/OK	To start the oven cooking and confirm settings.
13	Cancel/Off	To cancel the oven cooking and exit settings.

# FEATURES

## CLOCK

The 12-hour clock displays the time of day when the oven is not in use.



### Setting the Clock

1. Press **SETTINGS**.
2. Press ▲ or ▼ repeatedly to select "CLO" in the display if it is not already selected.
3. Press **START/OK**.
4. Press/Hold ▲ or ▼ to adjust the clock.
5. Press **START/OK** to start the clock.

# TIMER

The timer serves as an extra timer in the kitchen that beeps when the set time has run out, and can be used during any of the other oven control functions. It does not start or stop cooking.

## Setting the Timer (Up to 10 Hours)

1. Press **TIMER ON/OFF** once.

"00:00" appears and "Timer" flashes in the display.

2. Press/Hold ▲ or ▼ to set the length of time.

3. Press **START/OK** to start the timer.

"Timer" turns solid in the display.

4. When the set time runs out, "End" shows in the display and the indicator tone sounds for one minute until **TIMER ON/OFF** is pressed.

### NOTE:

- Pressing **CANCEL/OFF** will not cancel the current timer, but will cancel any oven cooking modes in progress.
- Pressing **CANCEL/OFF** will recall the remaining time in the display when no oven cooking mode is in progress.
- For remaining time less than a minute, the display shows MM:SS (minutes : seconds); for remaining time over a minute, the display shows HH:MM (hours : minutes).

## Canceling the Timer

1. Press **TIMER ON/OFF** once.



# SETTINGS

The oven has a variety of settings which can be accessed and adjusted using the **SETTINGS** button. These settings can only be adjusted or activated while no oven operation is in progress. All adjustments remain in the control's memory after a power failure or until changed.

Settings	Description	Default
CLO	Clock <ul style="list-style-type: none"><li>Set the time of day.</li></ul>	12:00
F-C	Temperature Scale <ul style="list-style-type: none"><li>Switch the temperature scale between Fahrenheit and Celsius.</li></ul>	°F
Son	Sound <ul style="list-style-type: none"><li>Turn control button sound on or off.</li></ul>	On
Err	Error Code Record <ul style="list-style-type: none"><li>Display the last 5 system error codes.</li></ul>	Null
CAL	Oven Temperature Calibration <ul style="list-style-type: none"><li>Adjust the oven offset temperature.</li></ul>	00°F
UEr	System Firmware Version <ul style="list-style-type: none"><li>Display the system firmware version.</li></ul>	
dIS	Demo Mode <ul style="list-style-type: none"><li>Turn demo mode on or off.</li></ul>	Off
rES	Reset <ul style="list-style-type: none"><li>Reset all the settings to factory defaults.</li></ul>	

## SETTING CLOCK

1. Press **SETTINGS**.
2. Press ▲ or ▼ repeatedly to select "CLO" in the display if it is not already selected.
3. Press **START/OK**.
4. Press/Hold ▲ or ▼ to adjust the clock.
5. Press **START/OK** to start the clock.

## SETTING TEMPERATURE SCALE

1. Press **SETTINGS**.
2. Press ▲ or ▼ repeatedly to select "F-C" in the display.
3. Press **START/OK**.
4. Press ▲ or ▼ to toggle and select °F (Fahrenheit) or °C (Celsius).
5. Press **START/OK** to confirm.

## TURNING ON/OFF CONTROL BUTTON SOUND

1. Press **SETTINGS**.
2. Press ▲ or ▼ repeatedly to select "Son" in the display.
3. Press **START/OK**.
4. Press ▲ or ▼ to toggle and select On or Off.
5. Press **START/OK** to confirm.

## DISPLAYING SYSTEM ERROR CODE RECORD

1. Press **SETTINGS**.
2. Press ▲ or ▼ repeatedly to select "Err" in the display.
3. Press **START/OK**.
4. Press ▲ or ▼ to toggle and display the last 5 error codes.
5. Press **START/OK** when finish.

## SETTING OVEN TEMPERATURE CALIBRATION

This oven may cook differently than the one it replaced. Use the oven for a few weeks to become more familiar with it before adjusting the thermostat settings. Do not use thermometers, such as those found in grocery stores, to check the temperature setting of your oven. These thermometers may vary 20–40 degrees.

1. Press **SETTINGS**.
2. Press ▲ or ▼ repeatedly to select "CAL" in the display.
3. Press **START/OK**.
4. Press/Hold ▲ or ▼ to adjust the offset temperature between -30°F and +30°F (-17°C and +17°C).
  - +30°F (+17°C) will raise the oven temperature and cook food more.
  - -30°F (-17°C) will reduce the oven temperature and cook food less.
5. Press **START/OK** to confirm.

## DISPLAYING SYSTEM FIRMWARE VERSION

1. Press **SETTINGS**.
2. Press ▲ or ▼ repeatedly to select "UEr" in the display.
3. Press **START/OK**.
4. Press **START/OK** when finish.

## TURNING ON/OFF DEMO MODE

Demo Mode allows user to explore various oven features and options and practice using the oven control without enabling any oven heating elements while the unit is on the showroom floor or in a retail store.

1. Press **SETTINGS**.
2. Press ▲ or ▼ repeatedly to select "dIS" in the display.
3. Press **START/OK**.
4. Press ▲ or ▼ to toggle and select On or Off.
5. Press **START/OK** to confirm.

## RESETTING ALL SETTINGS

Reset all the settings to factory defaults.

1. Press **SETTINGS**.
2. Press ▲ or ▼ repeatedly to select "rES" in the display.
3. Press **START/OK**.
4. Press **START/OK** to confirm.

## OVEN LIGHT

The oven light automatically turns on when the door is opened and turns off when the door is closed.

- Turn **LIGHT** knob to control the oven light when the oven door is closed.

# OPERATION

## COOKTOP

### BEFORE USING THE COOKTOP

Read all instructions before using.

#### **WARNING**

- Do not cook on a broken cooktop. If the cooktop is broken, cleaning solutions and spillovers may penetrate the broken cooktop and create a risk of electric shock. Contact a qualified technician immediately.
- Do not place or store items that can melt or catch fire on the glass cooktop, even when it is not being used.
- Never leave surface units unattended at high heat settings. Boilovers cause smoking and greasy spills that may catch on fire.
- Keep flammable items away from the cooktop.
- Turn off all controls when done cooking.
- Turn cookware handles inward and not extend over adjacent surface units to reduce the risk of burns, ignition of flammable materials, and spillage due to unintentional contact with the cookware.
- Always place the pan in the center of the surface unit you are cooking on. Proper contact of cookware to heating element also will improve efficiency.
- Clean cooktop with caution. If a wet sponge or cloth is used to wipe spills on a hot cooking area, be careful to avoid steam burn. Some cleaners can produce noxious fumes if applied to a hot surface.

## CAUTION

- Never cook directly on the glass. Always use cookware.
- Do not use the glass cooktop surface as a cutting board.
- Do not slide metal or glass across the cooktop surface. Cookware with rough or uneven bottoms can mark or scratch the cooktop surface.
- Do not place sealed containers on the cooktop.
- Do not place aluminum foil or plastic items such as salt and pepper shakers, spoon holders, or plastic wrappings or any other material on the range when it is in use.
- Do not turn surface units on before placing cookware.
- Always turn the surface units off before removing cookware.
- The surface element may appear to have cooled after it has been turned off. The element may still be hot and touching the element before it has cooled sufficiently can cause burns.
- Only certain types of glass, glass-ceramic, ceramic, earthenware, or other glazed cookware are suitable for range-top service without breaking due to the sudden change in temperature.
- Choose proper heating element size. For smaller pots and pans, use the smaller heating elements. For larger pots and pans, use the larger heating elements. Select pans that have flat bottoms large enough to cover the heating elements. Using undersized pans exposes a portion of the heating element to direct contact and may result in clothing burning.
- Immediately clean spills on the cooking area to prevent a tough cleaning chore later.
- Do not use a steel-wool pad or scrub pad or abrasive cleaning pads. They can scratch the surface.

## COOKING AREAS

The cooking areas on your range are identified by permanent circles on the glass cooktop surface.

For the most efficient cooking, fit the pan size to the element size. Pans should not extend more than 1/2" to 1" (1.3 cm to 2.5 cm) beyond the cooking area.

When a control is turned on, a glow can be seen through the glass cooktop surface.

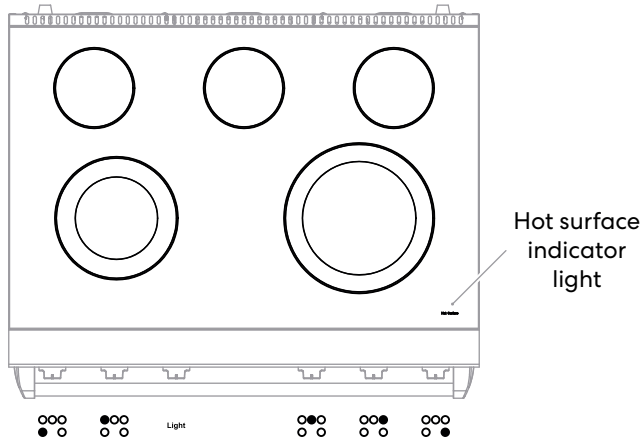

### NOTE:

- It is normal for the cooktop elements to cycle on and off during cooking, even on higher settings.

## HOT SURFACE INDICATOR

The hot surface indicator light glows and indicates that one or more cooktop elements are still hot. When the hot surface indicator turns off, the glass surface may still feel slightly hot to touch.

### NOTE:

- The hot surface indicator light glows 30 seconds after an element is turned on or when the surface temperature reaches 150°F (65°C).
- The hot surface indicator light remains on after the element is turned off and until the surface has cooled to approximately 150°F (65°C).

# USING THE COOKTOP ELEMENTS

## Turning on a Single Element

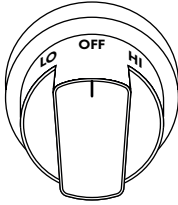

OFF position

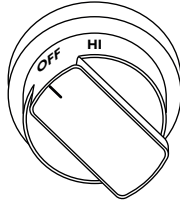

HI position

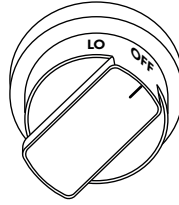

LO position

1. Select a single element, and find its control knob.
2. Push the control knob in and turn it in either direction to the desired setting.
3. To turn off an element, turn the control knob to the OFF position.

## Turning on a Dual Element

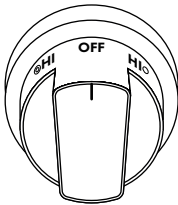

OFF position

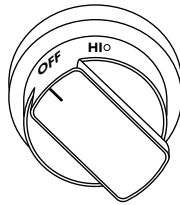

Single element  
HI position

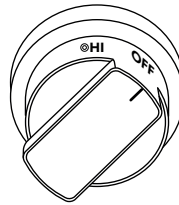

Dual element  
HI position

1. Select a dual element, and find its control knob.
2. Push the control knob in and turn it in either direction to use it as a single element or a dual element.
  - Single: Turn the knob counterclockwise.
  - Dual: Turn the knob clockwise.
3. To turn off an element, turn the control knob to the OFF position.



## **In Case of Power Failure**

The electric cooktop and oven cannot be used during a power outage.

If power is lost while a cooktop element is on, the cooktop element will turn back on as soon as power is restored.

In the event of power loss, failure to turn all cooktop element knobs to the OFF position may result in ignition of items on or near the cooktop, leading to serious injury or death.

## **USING THE PROPER COOKWARE**

The size and type of cookware will influence the settings needed for the best cooking results. Cookware should have flat bottoms that make good contact with the entire surface heating element. Using the correct cookware can prevent many problems, such as uneven cooking or extended cooking times.

### **Cookware Recommendations**

- Flat bottom and straight sides
- Heavy-gauge pans
- Pan sizes that match the amount of food to be prepared and the size of the surface element
- Weight of handle does not tilt pan.
- Pan is well balanced
- Tight-fitting lids
- Flat bottom woks

#### **NOTE:**

- Do not use woks that have support rings. This type of wok will not heat on glass surface elements.
- Do not use foil or foil-type containers. Foil may melt onto the glass. Do not use the cooktop if metal has melted on it.

## Choosing Cookware

The cookware material determines how evenly and quickly heat is transferred from the surface element to the pan bottom.

### Recommended

- **Aluminum** - Excellent heat conductor. Some types of food will cause it to darken (anodized aluminum cookware resists staining and pitting). If aluminum pans slide across the ceramic cooktop, they may leave metal marks which will resemble scratches. Remove these marks immediately. Because of its low melting point, thin weight aluminum should not be used.
- **Copper** - Excellent heat conductor but discolors easily. May leave metal marks on glass-ceramic (see Aluminum above). Do not let these pots boil dry. Overheated metal can bond to glass cooktops. An overheated copper bottom pot will leave a residue that will permanently stain the cooktop if not removed immediately.
- **Stainless Steel** - Slow heat conductor with uneven cooking results. Is durable, easy to clean and resists staining.
- **Enamel (painted) on Cast Iron** - Bottom of pan must be smooth coated and smooth.

### Not Recommended

- **Enamel (painted) on Steel** - Heating empty pans can cause permanent damage to cooktop glass. The enamel can melt and bond to the ceramic cooktop.
- **Cast iron** - A poor heat conductor, slow to absorb heat but retains heat very well. Will scratch the glass surface. Not recommended unless designed specifically for use on ceramic cooktops.
- **Glass-ceramic** - Slow heat conductor. Poor performance, and will scratch the glass surface.
- **Stoneware** - Poor performance, and may scratch the glass surface.

# OVEN

## BEFORE USING THE OVEN

Read the instructions for each feature and cooking mode in this manual carefully before using the oven.

### CAUTION

- Do not use any type of foil or oven liner to cover the oven bottom. These items can trap heat or melt, resulting in damage to the product and risk of shock, smoke or fire. Damage from improper use of these items is not covered by the product warranty.
- Foil may be used to catch spills by placing a sheet on a lower rack, several inches below the food. Do not use more foil than necessary and never entirely cover an oven rack with aluminum foil. Keep foil at least 1-1/2" (3.8 cm) from oven walls to prevent poor heat circulation.
- Do not cover the slotted grid of the 2-piece broiler pan with aluminum foil. This will catch the grease and could cause fire.
- Do not use plastic wrap or wax paper in the oven.
- Do not place food, water, ice, or any dish or tray directly on the oven floor, as this will irreversibly damage the enamel surface.
- Do not block, touch or place items around the oven vent during cooking. Your oven is vented through ducts at the center above the rear cooktop. Do not block the oven vent when cooking to allow for proper air flow.
- The oven and broiler cannot be used during a power outage. If the oven is in use when a power failure occurs, the oven heating element shuts off and cannot be used until power is restored. Once power is restored, you will need to reset the oven (or Broil mode).
- As the oven heats up, the heated air in the oven may cause condensation to appear on the oven door glass. These water drops are harmless and will evaporate as the oven continues to heat up.

#### NOTE:

- Because the oven temperature cycles, an oven thermometer placed in the oven cavity may not show the same set temperature on the oven.

## **WARNING**

### **FOOD POISONING HAZARD**

- Do not let food sit in oven more than one hour before or after cooking. Doing so can result in food poisoning or sickness.
- Foods that can easily spoil such as milk, eggs, fish, meat or poultry, should be chilled in the refrigerator first. Even when chilled, they should not stand in the oven for more than 1 hour before cooking begins, and should be removed promptly when finished cooking.

## **BEFORE USING THE OVEN FOR THE FIRST TIME**

Start the oven in Bake mode at the highest available temperature setting. Allow oven to run for 1 hour to remove any dust or impurities. There will be a distinctive odor - this is normal. Ensure your kitchen is well ventilated during this conditioning period.

## **OVEN VENT**

Areas near the vent may become hot during operation and may cause burns. Avoid placing plastics near the vent as heat may distort or melt the plastic.

Do not block the vents (air openings) of the range. They provide the air inlet and outlet that are necessary for the range to keep cool and operate properly with correct combustion.

It is normal for steam to be visible when cooking foods with high moisture content.

## **OVEN DOOR**

Oven heating elements and, if in operation, convection fan will temporarily shut off any time door is opened, and will resume when door is closed within 3 minutes.

### **NOTE:**

- Do not leave the door open any longer than necessary. If the door is left open too long for over 3 minutes, the cooking mode will be automatically cancelled.

## USING OVEN RACKS

The racks have a turned-up back edge that prevents them from being pulled out of the oven cavity.

### CAUTION

- Replace oven racks before turning the oven on to prevent burns.
- Do not cover the racks with aluminum foil, or any other material, or place anything on the bottom of the oven. Doing so will result in poor baking and may damage the oven bottom.
- Only arrange oven racks when the oven is cool.

### Removing Racks

1. Pull the rack straight out until it stops.
2. Lift up the front of the rack and pull it out.

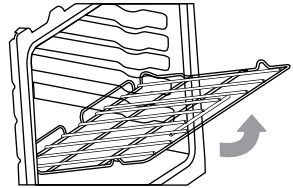

### Replacing Racks

1. Place the end of the rack on the support.
2. Tilt the front end up and push the rack in.

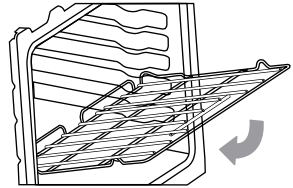

### Rack Positions

For best cooking results, adjust rack so food is placed at the center of the oven. For most foods this will be rack position #3 or #4. For larger foods like roasts and turkey, move the rack position down to #2 or #1 to keep the food centered in the oven.

When using multiple racks simultaneously, try to space the food out around the oven center (rack positions #3 and #5 or #2 and #4 for two racks).

Broiling performs best with the food close to the broil heating element - typically rack position #5 or #6.

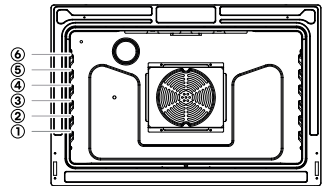

## PREHEATING

Preheating is generally desirable, although not absolutely necessary in all circumstances.

- For oven modes that utilizes preheat, the control will automatically enter preheat mode and show "100°F" after **START/OK** is pressed to turn on the oven.
  - When the oven temperature reaches 100°F, the display will show the current oven temperature, and will continue to show the oven temperature increasing until the set temperature is reached.
  - Once the set temperature is reached, a tone will sound to alert the user that preheat is complete.
- For oven modes that do not utilizes preheat (Broil and Warm), the control will show the set temperature after **START/OK** is pressed to turn on the oven.

Some foods are more robust and may have acceptable results without preheating. These foods include large pieces of meat (whole roasts, hams, or poultry) where the total cooking time is much longer than the time required to preheat. These foods also include frozen potato products and frozen processed dinners that, by their nature and design, are more robust to baking variations. More delicate foods, such breads (including cakes, cookies, pastries, and pizzas), desserts, soufflés, etc. will likely not have acceptable results without proper preheating.

### NOTE:

- It is normal for the convection fan to operate during preheating of various baking modes.

## COOKING MODES

The various baking modes (Bake, Conv Bake, Conv Roast, and Pizza) have a 10-hour time limit, after which the control will automatically end the baking mode. Broil and Warm modes have a 3-hour time limit. If desired, these modes can be restarted after the time limit expires.

Cooking Mode	Temperature			Maximum Cook Time (hh:mm)
	Minimum	Maximum	Default/Target	
Bake	175°F (79°C)	550°F (287°C)	350°F (176°C)	09:59
Conv Bake	175°F (79°C)	550°F (287°C)	325°F (162°C)	09:59
Conv Roast	175°F (79°C)	550°F (287°C)	325°F (162°C)	09:59
Pizza	175°F (79°C)	550°F (287°C)	425°F (218°C)	09:59
Warm	-	-	175°F (79°C)	02:59
Broil	-	-	Hi: 550°F (287°C) Lo: 400°F (204°C)	-

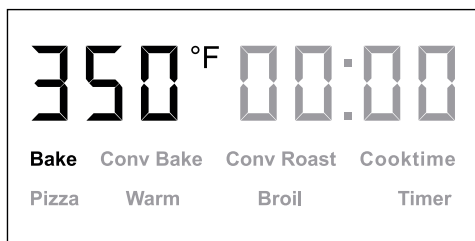

TIMER  
ON/OFF



START  
OK

SETTINGS



CANCEL  
OFF

## BAKE

The Bake mode uses heat from the lower heating element to cook food. This mode works best with food placed on a single rack. Always preheat the oven first and place food centrally near the middle racks.

### Setting the Bake Mode

1. Press ▲ or ▼ repeatedly to select "Bake" in the display.
  2. Press **START/OK**.  
The default set temperature "350°F" ("176°C") flashes in the display.
  3. [Optional] Press/Hold ▲ or ▼ to set the desired bake mode temperature.
  4. Press **START/OK**.  
"Cooktime" appears and "00:00" (hour:minute) flashes in the display.
  5. [Optional] Press/Hold ▲ or ▼ to set the desired length of cooking time.
  6. Press **START/OK**.  
The oven turns on and starts preheating. As the oven preheats and reaches 100°F, the display will show the current oven temperature, and will continue to show the oven temperature increasing until the set temperature is reached. Once the oven reaches the set temperature, a tone sounds.
  7. Place the food in the oven after preheating.  
If a Cook Time is set, the countdown will begin automatically.
- NOTE:**

  - Do not leave the door open any longer than necessary when placing food. If the door is left open too long for over 3 minutes, the cooking mode will be automatically cancelled.
8. Press **CANCEL/OFF** when cooking is finished, and remove the food from the oven.



If a Cook Time is set and the countdown reaches 00:00, the oven turns off automatically. The display shows "End" and a cook end tone sounds for 1 minute or stops when the oven door is opened.

**NOTE:**

- Baking time and temperature will vary depending on the characteristics, size, and shape of the baking pan used.
- Check for food doneness at the minimum recipe time.
- Use metal bakeware (with or without a nonstick finish), heatproof glass-ceramic, ceramic or other bakeware recommended for oven use.
- Dark metal pans or nonstick coatings will cook food faster with more browning. Insulated bakeware will slightly lengthen the cooking time for most foods.

## CONV BAKE

The Convection Bake mode uses heat from the lower heating element and air movement from the convection fan to enhance cooking efficiency and evenness across multiple racks. Always preheat the oven first. Baking times may be slightly longer for multiple racks than what would be expected for a single rack.

### Setting the Conv Bake Mode

1. Press ▲ or ▼ repeatedly to select "Conv Bake" in the display.
2. Press **START/OK**.  
The default set temperature "325°F" ("162°C") flashes in the display.
3. [Optional] Press/Hold ▲ or ▼ to set the desired convection bake mode temperature.
4. Press **START/OK**.  
"Cooktime" appears and "00:00" (hour:minute) flashes in the display.

5. [Optional] Press/Hold ▲ or ▼ to set the desired length of cooking time.

6. Press **START/OK**.

The oven turns on and starts preheating. As the oven preheats and reaches 100°F, the display will show the current oven temperature, and will continue to show the oven temperature increasing until the set temperature is reached. Once the oven reaches the set temperature, a tone sounds.

7. Place the food in the oven after preheating.

If a Cook Time is set, the countdown will begin automatically.

**NOTE:**

- Do not leave the door open any longer than necessary when placing food. If the door is left open too long for over 3 minutes, the cooking mode will be automatically cancelled.

8. Press **CANCEL/OFF** when cooking is finished, and remove the food from the oven.

If a Cook Time is set and the countdown reaches 00:00, the oven turns off automatically. The display shows "End" and a cook end tone sounds for 1 minute or stops when the oven door is opened.

**NOTE:**

- The oven fan runs while convection baking.
- Use Convection Bake for faster and more even multiple-rack cooking of pastries, cookies, muffins, biscuits, and breads of all kinds.
- Place the oven racks in positions suggested in the "Tips and Techniques" section.
- Bake cookies and biscuits on pans with no sides or very low sides to allow heated air to circulate around the food. Food baked on pans with a dark finish will cook faster.

## CONV ROAST

The Convection Roast mode uses heat from both upper and lower elements and air movement from the convection fan to enhance cooking efficiency and evenness across multiple racks. Ideal for roasting meats and poultry.

Heated air circulates around the food from all sides, sealing in juices and flavors. Foods are crispy brown on the outside while staying moist on the inside. A meat probe may be used with this feature. Roasting times may be slightly longer for multiple racks than what would be expected for a single rack.

### Setting the Conv Roast Mode

1. Press ▲ or ▼ repeatedly to select "Conv Roast" in the display.

2. Press **START/OK**.

The default set temperature "325°F" ("162°C") flashes in the display.

3. [Optional] Press/Hold ▲ or ▼ to set the desired convection roast mode temperature.

4. Press **START/OK**.

"Cooktime" appears and "00:00" (hour:minute) flashes in the display.

5. [Optional] Press/Hold ▲ or ▼ to set the desired length of cooking time.

6. Press **START/OK**.

The oven turns on and starts preheating. As the oven preheats and reaches 100°F, the display will show the current oven temperature, and will continue to show the oven temperature increasing until the set temperature is reached. Once the oven reaches the set temperature, a tone sounds.

7. Place the food in the oven after preheating.

If a Cook Time is set, the countdown will begin automatically.

**NOTE:**

- Do not leave the door open any longer than necessary when placing food. If the door is left open too long for over 3 minutes, the cooking mode will be automatically cancelled.

8. Press **CANCEL/OFF** when cooking is finished, and remove the food from the oven.

If a Cook Time is set and the countdown reaches 00:00, the oven turns off automatically. The display shows "End" and a cook end tone sounds for 1 minute or stops when the oven door is opened.

**NOTE:**

- The oven fan runs while convection roasting.
- Always use a broiler pan and grid for excess fat and grease drainage. This will help to reduce splatter, smoke, and flare-ups.
- Do not use a broiler pan without a grid. Oil can cause a grease fire.
- Do not cover the grid and broiler pan with aluminum foil. Doing so will cause a fire.

## PIZZA

The Pizza mode uses heat from the lower heating element and adopts customized heating algorithm to optimize baking performance for pizza, which is also ideal for pastries and cakes with wet covering and little sugar and damp desserts in moulds, or dishes requiring more heat in the lower area. Always preheat the oven first and place food near the middle racks.

### Setting the Pizza Mode

1. Press ▲ or ▼ repeatedly to select "Pizza" in the display.
2. Press **START/OK**.

The default set temperature "425°F" ("218°C") flashes in the display.

3. [Optional] Press/Hold ▲ or ▼ to set the desired pizza mode temperature.

**4. Press START/OK.**

"Cooktime" appears and "00:00" (hour:minute) flashes in the display.

**5. [Optional] Press/Hold ▲ or ▼ to set the desired length of cooking time.**

**6. Press START/OK.**

The oven turns on and starts preheating. As the oven preheats and reaches 100°F, the display will show the current oven temperature, and will continue to show the oven temperature increasing until the set temperature is reached. Once the oven reaches the set temperature, a tone sounds.

**NOTE:**

- Do not leave the door open any longer than necessary when placing food. If the door is left open too long for over 3 minutes, the cooking mode will be automatically cancelled.

**7. Place the food in the oven after preheating.**

If a Cook Time is set, the countdown will begin automatically.

**8. Press CANCEL/OFF when cooking is finished, and remove the food from the oven.**

If a Cook Time is set and the countdown reaches 00:00, the oven turns off automatically. The display shows "End" and a cook end tone sounds for 1 minute or stops when the oven door is opened.

## WARM

The Warm mode uses heat from the lower heating element to maintain oven temperature at around 175°F (79°C). It will keep cooked food warm for serving up to 3 hours after cooking has finished. Cover foods that need to remain moist and do not cover foods that should be crisp. Preheating is not required. This mode should not be used to reheat cold food.

### NOTE:

- Do not use to Warm mode to heat cold food. Always start with hot food.
- It is recommended that food not be kept warm for more than 2 hours.
- The warm mode is intended to keep food warm. Do not use it to cool food down.
- Avoid opening the oven door more than necessary during use. If the door is left open too long for over 3 minutes, the cooking mode will be automatically cancelled.

### Setting the Warm Mode

1. Place the hot food in the oven.

2. Press ▲ or ▼ repeatedly to select "Warm" in the display.

3. Press **START/OK**.

"Cooktime" appears and "00:00" (hour:minute) flashes in the display.

4. [Optional] Press/Hold ▲ or ▼ to set the desired length of warming time.

5. Press **START/OK**.

The oven turns on and starts preheating. If a Cook Time is set, the countdown will begin automatically.

6. Press **CANCEL/OFF** when warming is finished, and remove the food from the oven.

If a Cook Time is set and the countdown reaches 00:00, the oven turns off automatically. The display shows "End" and a cook end tone sounds for 1 minute or stops when the oven door is opened.

## BROIL

The Broil mode uses intense heat from the upper heating element to sear foods. This mode works best for tender cuts of meat, fish, and thinly cut vegetables, and is ideal for toasting, melting cheese, browning and searing surface. Food should be placed near the upper racks, and should not be cooked for too long on each side of the food.

### Setting the Broil Mode

1. Press ▲ or ▼ repeatedly to select "Broil" in the display.
2. Press **START/OK**.  
The default set temperature "HI" flashes in the display.
3. [Optional] Press ▲ or ▼ to select "HI" 550°F (287°C) or "Lo" 400°F (204°C) broil mode temperature.
4. Press **START/OK**.  
The oven turns on and starts preheating.
5. Let the oven preheat for approximately 5 – 10 minutes, and place the food in the oven.
6. Press **CANCEL/OFF** when cooking is finished, and remove the food from the oven.

#### NOTE:

- The oven of this range is designed for closed-door broiling.
- Opening the door turns off the broil heating element during broiling. If the door is not closed, the Broil mode will ultimately cancel itself.
- The broil heating element is very powerful. Follow recipe directions and monitor food closely to reduce risk of burning food.
- Always use a broiler pan and grid for excess fat and grease drainage. This will help to reduce splatter, smoke, and flare-ups.
- Do not use a broiler pan without a grid. Oil can cause a grease fire.
- Do not cover the grid and broiler pan with aluminum foil. Doing so will cause a fire.

# TIPS AND TECHNIQUES

## BAKE

Baking is cooking with heated air. The lower element in the oven is used to heat the air but no fan is used to circulate the heat.

Follow the recipe or convenience food directions for baking temperature, time and rack position. Baking time will vary with the temperature of ingredients and the size, shape and finish of the baking utensil.

- For best results, bake food on a single rack with at least 1" - 1½" (2.5 - 3 cm) space between utensils and oven walls.
- Use one rack when selecting the bake mode.
- Check for doneness at the minimum time.
- Use metal bakeware (with or without a non-stick finish), heatproof glass, glass-ceramic, pottery or other utensils suitable for the oven.
- When using heatproof glass, reduce temperature by 25°F (15°C) from recommended temperature.
- Use baking sheets with or without sides or jelly roll pans.
- Dark metal pans or nonstick coatings will cook faster with more browning. Insulated bakeware will slightly lengthen the cooking time for most foods.
- Do not use aluminum foil or disposable aluminum trays to line any part of the oven. Foil is an excellent heat insulator and heat will be trapped beneath it. This will alter the cooking performance and can damage the finish of the oven.
- Avoid using the opened door as a shelf to place pans.
- See Troubleshooting for tips on solving Oven Problems.



## Bake Chart

FOOD ITEM	RACK POSITION	TEMPERATURE SETTING °F (°C) (PREHEATED OVEN)	TIME (MIN)
<b>Cake</b>			
Cupcakes	4	350 (175)	19-22
Bundt Cake	3	350 (175)	40-45
Angel Food	3	350 (175)	35-39
<b>Pie</b>			
2 crust, fresh, 9"	4	375-400 (190-205)	45-50
2 crust, frozen fruit, 9"	4	375 (190)	68-78
<b>Cookies</b>			
Sugar	4	350-375 (175-190)	8-10
Chocolate Chip	4	350-375 (175-190)	8-13
Brownies	4	350 (175)	29-36
<b>Breads</b>			
Yeast bread loaf, 9"x5"	3	375 (190)	18-22
Yeast rolls	3	375-400 (190-205)	12-15
Biscuits	4	375-400 (190-205)	7-9
Muffins	3	425 (220)	15-19
<b>Pizza</b>			
Frozen	4	400-450 (205-235)	23-26
Fresh	4	475 (246)	15-18

## CONVECTION BAKE

Convection Bake uses heat from the lower heating element and air movement from the convection fan to enhance cooking efficiency and evenness across multiple racks. Reduce recipe baking temperatures by 25°F (15°C).

- For best results, foods should be cooked uncovered, in low-sided pans to take advantage of the forced air circulation. Use shiny aluminum pans for best results unless otherwise specified.
- Heatproof glass or ceramic can be used. Reduce temperature by another 25°F (15°C) when using heatproof glass dishes for a total reduction of 50°F (30°C).
- Dark metal pans may be used. Note that food may brown faster when using dark metal bake ware.
- The number of racks used is determined by the height of the food to be cooked.
- Baked items, for the most part, cook extremely well in convection. Don't try to convert recipes such as custards, quiches, pumpkin pie, or cheesecakes, which do not benefit from the convection-heating process. Use the regular Bake mode for these foods.
- Multiple rack cooking for oven meals is done on rack positions 1, 2, 3, 4, 5, and 6. All six racks can be used for cookies, biscuits and appetizers.

- 2 Rack baking: Use positions 3 and 5 or 2 and 4.
- 3 rack baking: Use positions 2, 3, and 4 or 1, 3, and 5 or 2, 4, and 6.
- When baking four cake layers at the same time, stagger pans so that one pan is not directly above another. For best results, place cakes on front of upper rack and back of lower rack (See graphic at right). Allow 1" - 1 ½" (2.5 - 3cm) air space around pans.

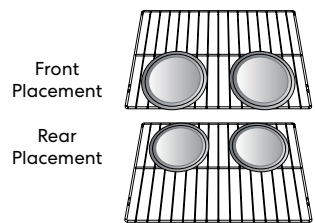
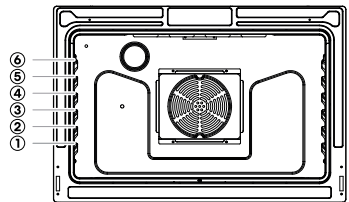

- Converting your own recipe can be easy. Choose a recipe that will work well in convection.
- Reduce the temperature and cooking time if necessary. It may take some trial and error to achieve a perfect result. Keep track of your technique for the next time you want to prepare the recipe using convection.
- See Troubleshooting for tips to Solving Baking and Roasting Problems.

**Foods recommended for convection bake mode:**

Appetizers, Biscuits, Cakes, Casseroles, Coffee Beans, Cookies (2 to 4 racks), Cream Puffs, Popovers, Yeast Breads, One-Dish Entrées, Oven Meals (rack positions 3 and 4), and Air Leavened Foods (Soufflés, Meringue, Meringue-Topped Desserts, Angel Food Cakes, Chiffon Cakes).

**Convection Bake Chart**

Reduce standard recipe temperature by 25 °F (15 °C) for Convection Bake. Temperatures have been reduced in this chart.

FOOD ITEM	RACK POSITION	TEMPERATURE SETTING °F (°C) (PREHEATED OVEN)	TIME (MIN)
<b>Cake</b>			
Cupcakes	3	325 (160)	20-22
Bundt Cake	3	325 (160)	43-50
Angel Food	3	325 (160)	43-47
<b>Pie</b>			
2 crust, fresh, 9"	3	350-400 (175-205)	40-52
2 crust, frozen fruit, 9"	3	350 (175)	68-78
<b>Cookies</b>			
Sugar	3	325-350 (160-175)	9-12
Chocolate Chip	3	325-350 (160-175)	8-13
Brownies	3	325 (160)	29-36
<b>Breads</b>			
Yeast bread loaf, 9"x5"	3	350 (175)	18-22
Yeast rolls	3	350-375 (175-190)	12-15
Biscuits	3	375 (190)	8-10
Muffins	3	400 (205)	17-21
<b>Pizza</b>			
Frozen	3	375-425 (190-220)	23-26
Fresh	3	450 (232)	15-18

## BROIL

The Broil mode uses intense heat from the upper heating element to sear foods. The size, weight, thickness, starting temperature, and your preference of doneness will affect broiling times.

- For best results when broiling, use a pan designed for broiling.
- Preheat the oven for about 5 minutes before placing food in the oven.

### Broil Chart

FOOD ITEM	RACK POSITION	BROIL SETTING	INTERNAL FOOD TEMP. °F (°C)	TIME SIDE 1 (MIN)	TIME SIDE 2 (MIN)
<b>Beef</b>					
Steak (¾"-1")					
Medium Rare	6	Hi	145 (65)	5-7	4-6
Medium	6	Hi	160 (71)	6-8	5-7
Well Done	6	Hi	170 (77)	8-10	7-9
Hamburgers (¾"-1")					
Medium	5	Hi	160 (71)	8-11	6-9
Well Done	5	Hi	170 (77)	10-13	8-10
<b>Poultry</b>					
Breast (bone-in)	5	Lo	170 (77)	10-12	8-10
Thigh (very well done)	5	Lo	180 (82)	28-30	13-15
<b>Pork</b>					
Pork Chips (1")	6	Hi	160 (71)	7-9	5-7
Sausage (fresh)	6	Hi	160 (71)	5-7	3-5
Ham Slice (½")	6	Hi	160 (71)	4-6	3-5
<b>Seafood</b>					
Fish Filets (1" buttered)	5	Lo	Cook until opaque & flakes easily with fork	10-14	Do not turn

FOOD ITEM	RACK POSITION	BROIL SETTING	INTERNAL FOOD TEMP. °F (°C)	TIME SIDE 1 (MIN)	TIME SIDE 2 (MIN)
<b>Lamb</b>					
Chops (1")					
Medium Rare	6	Hi	145 (63)	5-7	4-6
Medium	6	Hi	160 (71)	6-8	4-6
Well Done	6	Hi	170 (77)	7-9	5-7
<b>Bread</b>					
Garlic Bread, (1" slices)	5	Hi		2-3	
Garlic Bread, (1" slices)	4	Hi		4-6	

## CONVECTION ROAST

The Convection Roast mode uses heat from both upper and lower elements and hot air movement from the convection fan to enhance cooking efficiency and evenness across multiple racks. Heated air circulates around the food from all sides, sealing in juices and flavors.

- Use the 2-piece broil pan, and roast in a low-sided, uncovered pan.
- When roasting whole chickens or turkey, tuck wings behind back and loosely tie legs with kitchen string.
- Use a meat thermometer to determine the internal doneness.
- Double-check the internal temperature of meat or poultry by inserting meat thermometer into another position.
- Large food item may need specific areas to be covered with foil (and pan roasted) during part of the roasting to prevent over-browning.
- The minimum safe temperature for stuffing in poultry is 165°F (75°C).
- After removing the item from the oven, cover loosely with foil for 10 to 15 minutes before carving if necessary to increase the final foodstuff temperature by 5°F to 10°F (3°C to 6°C).

## Convection Roasting Chart

FOOD ITEM	WT (LB)	RACK POS.	TEMP. SETTING °F (°C)	INTERNAL FOOD TEMP. °F (°C)	TIME (MIN/LB)
<b>Beef</b>					
Rib Roast	4-6	3	325 (160)		
Medium Rare				145 (63)	16-20
Medium				160 (71)	18-22
Rib Eye Roast	4-6	3	325 (160)		
Medium Rare				145 (63)	16-20
Medium				160 (71)	18-22
Rump, Eye, Tip, Sirloin	3-6	3	325 (160)		
Medium Rare				145 (63)	16-20
Medium				160 (71)	18-22
Tenderloin Roast	2-3	3	400 (205)		
Medium Rare				145 (63)	15-20
<b>Pork</b>					
Loin Roast - Medium	5-8	3	350 (175)	160 (71)	16-20
Shoulder - Medium	3-6	3	350 (175)	160 (71)	20-25
<b>Poultry</b>					
Chicken Whole	3-4	3	375 (190)	180 (82)	18-21
Turkey (unstuffed)	12-15	2	325 (160)	180 (82)	10-14
Turkey (unstuffed)	16-20	2	325 (160)	180 (82)	9-11
Turkey (unstuffed)	21-25	2	325 (160)	180 (82)	6-10
Turkey Breast	3-8	2	325 (160)	170 (77)	15-20
Cornish Hen	1-1½"	3	350 (175)	180 (82)	45-75
<b>Lamb</b>					
Half Leg	3-4	3	325 (160)		
Medium				160 (71)	22-27
Well Done				170 (77)	28-33
Whole Leg	6-8	2	325 (160)		
Medium				160 (71)	22-27
Well Done				170 (77)	28-33

# RANGE CARE AND MAINTENANCE

## CLEANING

**IMPORTANT:** Before cleaning, make sure all controls are off and the oven and cooktop are cool. Always follow label instructions on cleaning products. Soap, water and a soft cloth or sponge are suggested first unless otherwise noted. Do not use abrasive cleaning products.

**NOTE:**

- Do not clean the oven door gasket. The material of the gasket cannot withstand abrasion. It is essential for the gasket to remain intact. If you notice it becoming worn or frayed, replace it.
- Re-engage the anti-tip bracket if range is moved.

## GLASS-CERAMIC COOKTOP

- Before using the cooktop for the first time, clean it with a ceramic cooktop cleaner. This helps protect the top and makes cleanup easier.
- Regular use of ceramic cooktop cleaner will help keep the cooktop looking new.
- If any sugar or food containing sugar spills, or plastic or foil melts on the cooktop, remove the material IMMEDIATELY with a metal razor scraper while the cooking surface is still hot to avoid the risk of damage to the glass-ceramic surface. When used correctly, the scraper will not damage the cooktop surface.
- For your safety, please use an oven mitt or pot holder while scraping the hot cooking surface.
- If water or food containing water spills, remove the spill IMMEDIATELY with a dry paper towel.
- Do not use scrub pads or abrasive cleaning pads. They may damage your cooktop surface.

### **Cleaning Method:**

- Use ceramic cooktop cleaner on the glass cooktop. Other creams may not be as effective or may scratch, damage or stain the cooktop surface.
- Use a paper towel or non-scratch cleaning pad to clean the entire cooktop surface.
- Rinse with clear water and use a dry cloth or paper towel to remove all cleaning residue.

#### **NOTE:**

- Any damage or failure of the product resulting from the items below may not be covered under the Limited Warranty.
  - Sugary spillovers (such as preserves, ketchup, tomato sauce, jellies, fudge, candy, syrups, or chocolate) or melted plastics can cause pitting on the surface of your cooktop.
  - If food or water containing calcium (such as baking powder, wine, milk, spinach, or broccoli) is spilled on the cooktop, it can permanently stain or discolor the surface.

### **BURNED-ON RESIDUE**

- Allow the cooktop to cool.
- For additional protection, after all residue has been removed, polish the entire surface with ceramic cooktop cleaner and a paper towel.

### **Cleaning Methods:**

- Spread a few drops of ceramic cooktop cleaner on the entire burned residue area. Using a non-scratch cleaning pad for ceramic cooktops, rub the residue area, applying pressure as needed. Leave the cleaner on for 10 minutes before rinsing it off.
- Rinse with clear water and wipe the cooktop surface with a clean, dry paper towel. If any residue remains, repeat the steps listed above as needed.

#### **NOTE:**

- Damage to your glass surface may occur if you use scrub pads other than those recommended.



## HEAVY BURNED-ON RESIDUE

- Allow the cooktop to cool.
- For additional protection, after all residue has been removed, polish the entire surface with ceramic cooktop cleaner and a paper towel.

### Cleaning Methods:

- While the cooktop is still warm, use a single-edge razor blade scraper at approximately a 30° to 45° angle against the glass surface and scrape the soil. It will be necessary to apply pressure to the razor scraper in order to remove the residue.
- When the cooking surface is completely cooled, spread a few drops of ceramic cooktop cleaner on the entire burned residue area. Using a non-scratch cleaning pad for ceramic cooktops, rub the residue area, applying pressure as needed. Leave the cleaner on for 10 minutes before rinsing it off.
- Rinse with clear water and wipe the cooktop surface with a clean, dry paper towel.

#### NOTE:

- Do not use a dull or nicked blade.

## METAL MARKS AND SCRATCHES

- Cookware with rough or uneven bottoms can mark or scratch the cooktop surface. Carefully check the bottom of pans.
- Do not slide metal or glass across the cooktop surface.
- Do not use cookware with any dirt build-up on the bottom.
- Always clean the cooktop surface before cooking.
- Be careful not to place aluminum baking sheets or aluminum frozen entrée containers on a hot cooktop surface. It will leave shiny dots or markings on the cooktop surface. These markings are permanent and cannot be cleaned off.

### **Cleaning Methods:**

- Be careful not to slide pots and pans across your cooktop. It will leave metal markings on the cooktop surface. These marks are removable using the ceramic cooktop cleaner with a non-scratch cleaning pad for ceramic cooktops.
- If pots with a thin overlay of aluminum or copper are allowed to boil dry, the overlay may leave black discoloration on the cooktop. This should be removed immediately before heating again or the discoloration may be permanent.

### **EXTERIOR STAINLESS STEEL**

- Rub in direction of grain to avoid damaging.

### **Cleaning Methods:**

- Liquid detergent or all-purpose cleaner: Rinse well with clean water and dry with soft, lint-free cloth.
- Stainless Steel Cleaner and Polish. Vinegar for hard water spots.

#### **NOTE:**

- Do not use soap-filled scouring pads, abrasive cleaners, cooktop polishing cream, steel-wool pads, gritty washcloths or some paper towels. Damage may occur, even with one-time or limited use.

### **OVEN DOOR**

- Do not immerse the door in water.
- Do not spray water or glass cleaner on the door vents.
- Do not use oven cleaners, cleaning powders, or harsh abrasive cleaning materials on the outside of the oven door.
- Do not clean the oven door gasket.

### **Cleaning Method:**

- Glass cleaner and paper towels or nonabrasive plastic scrubbing pad: Apply glass cleaner to soft cloth or sponge, not directly on panel.

## COOKTOP CONTROL KNOBS

- Pull knobs straight away from control panel to remove.
- When replacing knobs, make sure knobs are in the OFF position.

### Cleaning Method:

- Wash with soap and water.

#### NOTE:

- Do not use steel wool, abrasive cleansers or oven cleaner. Do not soak knobs.

## CONTROL PANEL

- It's a good idea to wipe the control panel after each use.
- Disconnect power to the unit before cleaning if needed.

### Cleaning Method:

- Glass cleaner and soft cloth or sponge: Apply glass cleaner to soft cloth or sponge, not directly on panel.
- Clean up splatters with a damp cloth.

#### NOTE:

- Do not use abrasive cleaners, steel-wool pads, gritty washcloths or some paper towels. Damage may occur.

## OVEN CAVITY

- Food spills should be cleaned when oven cools. At high temperatures, foods react with porcelain, so staining, etching, pitting or faint white spots can result.

### **Cleaning Method:**

- Mild detergent and warm water.

#### **NOTE:**

- Do not use oven cleaners.
- To better reach and clean the oven cavity, detach the oven door from the range. See "Removing/Assembling Oven Door" section in the Installation Instructions manual.

## OVEN RACKS

- All racks can be washed with warm, soapy water.

### **Cleaning Method:**

- Clean with warm, soapy water, and use steel-wool pad if necessary.
- Rinse with clean water and dry.

# TROUBLESHOOTING

First try the solutions suggested here to possibly avoid the cost of a service call.

## COOKTOP PROBLEMS

PROBLEM	POSSIBLE CAUSE	SOLUTION
<b>Surface units do not turn on</b>	There is no power to the range.	Make sure electrical plug is plugged into a live, properly grounded outlet. Replace the fuse or reset the circuit breaker.
	Cooktop controls improperly set.	Check to see the correct control is set for the surface unit you are using.
<b>Excessive heat around cookware on cooktop</b>	The cookware is not the proper size for the element or burner.	Use cookware with a bottom surface approximately the same size as the cooking area, element, or surface burner. Cookware should not extend more than 1" (2.5 cm) outside the cooking area. Adjust the power level or burner flame appropriately.
<b>Frequent cycling on and off of surface units</b>	The element cycle on and off to maintain the heat setting.	This is normal even when the element is on the highest setting.
<b>Surface unit stops glowing when changed to a lower setting</b>	The unit is still on and hot.	This is normal.
<b>Cooking results are not what expected</b>	Using incorrect cookware.	See "Using the Proper Cookware" in the "Operation" section.
	The control knob is not set to the proper heat level.	See "Using the Cooktop Elements" in the "Operation" section.

<b>PROBLEM</b>	<b>POSSIBLE CAUSE</b>	<b>SOLUTION</b>
<b>Unable to maintain a rolling boil or will not cook fast enough</b>	Using improper cookware.	Use pans with flat bottoms and that match the diameter of the cooktop element selected. See "Using the Cooktop Elements" in the "Operation" section.
	Using large cookware without lid.	Large pots and pans can lose a lot of heat from the top. Cover pot or pan with a lid to retain heat better.
<b>Areas of discoloration on the cooktop</b>	Food spillovers not cleaned before next use.	See "Cleaning" in the "Range Care and Maintenance" section.
	Cooktop is not cleaned thoroughly.	See "Cleaning" in the "Range Care and Maintenance" section.
	Mineral deposits from water and food.	Remove using a glass-ceramic cooktop cleaning crème. Use cookware with clean, dry bottoms.
<b>Scratches or abrasions on cooktop surface</b>	Coarse particles such as salt or sand between cooktop and utensils can cause scratches.	Be sure the cooktop surface and bottoms of utensils are clean before using. Small scratches do not affect cooking and will become less visible with time.
	Cookware with rough bottom has been used.	Use smooth, flat-bottomed cookware.
	Cleaning materials not recommended for glass-ceramic cooktop have been used.	See "Cleaning" in the "Range Care and Maintenance" section.

PROBLEM	POSSIBLE CAUSE	SOLUTION
<b>Metal marks</b>	Scraping of metal utensils on cooktop surface.	Do not slide metal utensils on cooktop surface. Use a glass-ceramic cooktop cleaning crème to remove the marks. See "Cleaning" in the "Range Care and Maintenance" section.
<b>Brown streaks or specks</b>	Boilovers are cooked onto surface.	Use a blade scraper to remove soil. See "Cleaning" in the "Range Care and Maintenance" section.

## OVEN PROBLEMS

PROBLEM	POSSIBLE CAUSE	SOLUTION
<b>Strong odor when using new oven</b>	Manufacturing protective coating on the oven surfaces.	This is normal with a new range and will disappear after a few uses.
	Packaging materials exist.	Double-check that all packaging has been removed from the appliance - check around door sides and inside drawer.
<b>Oven is not heating</b>	No power to the range.	Check the circuit breaker or fuse box to your house. Make sure there is proper electrical power to the oven.
	Oven control not turned on.	Make sure the oven temperature has been selected.
<b>Oven is taking too long to cook</b>	All ovens operate slightly differently from each other.	Adjust oven calibration upwards to make oven cook faster. See "Setting Oven Temperature Calibration" in the "Settings" section.
<b>Food is overcooked</b>	All ovens operate slightly differently from each other.	Adjust oven calibration downwards to reduce overcooking. See "Setting Oven Temperature Calibration" in the "Settings" section.

<b>PROBLEM</b>	<b>POSSIBLE CAUSE</b>	<b>SOLUTION</b>
<b>Oven is not cooking evenly</b>	Not using the correct bakeware or oven rack position.	Refer to "Using Oven Racks" in the "Oven" section and the cook charts for recommended rack position. Always reduce recipe temperature by 25°F (15°C) when baking with Convention Bake mode.  Recipe may perform better at a different rack position. Try moving the food down a rack position to make the bottom darker. Try moving food up a rack position to make the top darker.
<b>Cooling fan continues to run after oven is turned off</b>	The electronic components have not yet cooled sufficiently.	The fan will turn off automatically when the electronic components have cooled sufficiently.
<b>Oven display stays Off</b>	Power interruption.	Turn off power at the main power supply (fuse or breaker box). Turn breaker back on. If condition persists, call for service.
<b>Oven display is on but will not respond</b>	System error.	Resetting the power at the breaker box can usually reset the oven control and clear response issues.
<b>Oven light is not working properly</b>	Light bulb loose or burned-out.	Reinsert or replace the light bulb. Touching the bulb with fingers may cause the bulb to burn out.
<b>Oven light stays on</b>	Door is not closing completely	Check for obstruction in oven door. Check to see if hinge is bent or door switch broken.
<b>Cannot remove lens cover</b>	Soil build-up around the lens cover.	Wipe lens cover area with a clean, dry towel prior to attempting to remove the lens cover.



PROBLEM	POSSIBLE CAUSE	SOLUTION
<b>Clock and timer are not working properly</b>	No power to the range.	Check the circuit breaker or fuse box to your house. Make sure there is proper electrical power to the oven.
<b>Excessive Moisture on door glass</b>	Condensation from cooking foods with high moisture content.	This is normal. Condensation will evaporate as oven heats up. Convection Bake and Convection Roast will eliminate any moisture in the oven.
<b>Porcelain Chips</b>	Porcelain interior is chipped by oven racks	When removing and replacing oven racks, always tilt racks upward and do not force them to avoid chipping the porcelain.
<b>"E" and a number appears in display</b>	System error detected.	This is an error code. Press <b>CANCEL/OFF</b> to clear the display and stop the beeping. If necessary, reset oven power at the circuit breaker. If error code remains or repeats, write down error code and contact a qualified service provider for repairs.

# LIMITED WARRANTY

## WARRANTY AND SERVICE

TO RECEIVE WARRANTY SERVICE, YOUR PRODUCT MUST BE REGISTERED.

TO REGISTER AND REVIEW FULL WARRANTY DETAILS, VISIT:

**[WWW.COSMOAPPLIANCES.COM/WARRANTY](http://WWW.COSMOAPPLIANCES.COM/WARRANTY)**

SCAN TO REGISTER

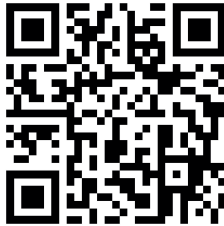

## CUSTOMER SUPPORT

TO CHAT WITH US LIVE FOR ASSISTANCE, VISIT:

**[WWW.COSMOAPPLIANCES.COM/CHAT](http://WWW.COSMOAPPLIANCES.COM/CHAT)**

SCAN TO CHAT



## **IMPORTANT**

### **Do Not Return This Product To The Store**

If you have a problem with this product, please contact COSMO Customer Support at

**+1 (888) 784-3108**

DATED PROOF OF PURCHASE, MODEL #, AND SERIAL # REQUIRED FOR WARRANTY SERVICE.

## **IMPORTANT**

### **Ne pas Réexpédier ce Produit au Magasin**

Pour tout problème concernant ce produit, veuillez contacter le service des consommateurs Cosmo Customer Support au

**+1 (888) 784-3108**

UNE PREUVE D'ACHAT DATEE EST REQUISE POUR BENEFICIER DE LA GARANTIE.

## **IMPORTANTE**

### **No regrese este producto a la tienda**

Si tiene algún problema con este producto, por favor contacte el ayuda al cliente COSMO al

**+1 (888) 784-3108**

(Válido solo en E.U.A.)

NECESITA UNA PRUEBA DE DE COMPRA FECHADA, NÚMERO DE MODELO Y DE SERIE PARA EL SERVICIO DE LA GARANTÍA.



#### **Correct disposal of this product:**

This marking indicates that this appliance should not be disposed with other household wastes. To prevent possible harm to the environment or human health from uncontrolled waste disposal, recycle it responsibly to promote the sustainable reuse of material resources.

# MEMO

# MEMO

A series of horizontal dashed lines for writing.

# MEMO

# MEMO

A series of horizontal dashed lines for writing.



**APPLIANCES**

Cosmo is constantly making efforts to improve the quality and performance of our products, so we may make changes to our appliances without updating this manual.

Electronic version of this manual is available at:  
[www.cosmoappliances.com](http://www.cosmoappliances.com)