

Instant Pot®
DUO
Series



User Manual

Table of Contents

Important Safeguards	2 - 5
Overview	6
Control and Features	7 - 11
Getting Started	12 - 14
Pressure Cooking	15 - 17
Non-Pressure Cooking	18 - 21
Cooking and Safety Tips	22
Care and Cleaning	23
Troubleshooting	24 - 26
Warranty	27 - 28

Pictures in manual are for reference only. Please refer to actual product.

Important Safeguards



SAVE THESE INSTRUCTIONS

When using pressure cookers, basic safety precautions should always be followed.

- 1) Do not touch hot surfaces of pressure cooker. Use side handles for carrying.
- 2) Do not place the cooker on or near a hot gas or electric burner, or in a heated oven.
- 3) Intended for countertop use only.
- 4) Do not use pressure cooker for anything other than intended use.
- 5) Never deep fry or pressure fry in the cooker with oil.
- 6) Do not let cord hang over edge of table or counter, or touch hot surfaces.
- 7) Do not use cooker in electrical systems other than 110-120V~/60Hz for North America.
- 8) Do not operate cooker with damaged cord or plug, or after the cooker malfunctions or has been damaged in any manner.
- 9) Do not open the unit until the cooker has cooled and all internal pressure has been released. If the float valve is still up or the lid is difficult to turn, it is an indication that the cooker is still pressurized - **do not force it open.**
Please see "Getting Started" pages 12-14.



- 10) For all pressure cooking programs, the total amount of pre-cooked food and liquid in the inner pot should not pass the 2/3 line. When cooking food that expands during cooking such as rice, beans or vegetables, food should not pass the 1/2 line. Overfilling may risk clogging the steam release resulting in excess pressure. This may also cause leakage, personal injuries, or damage to the cooker. These fill level warnings do not apply to non-pressure cooking programs.



Important Safeguards



- 11) Make sure the steam release handle is in the **Sealing** position during all pressure cooking programs.
- 12) This appliance should not be used by or near children or by individuals with disabilities or limited knowledge in using pressure cookers.
- 13) Do not immerse the cooker base in water. To protect against electrical shock, do not immerse the cord, power plug, or cooker in any liquid.
- 14) Always attach plug to the cooker first, then plug cord into the wall outlet. To disconnect, press **Cancel**, then remove plug from the wall outlet. Unplug from power outlet when not in use and before cleaning. Allow the cooker to cool before putting on or taking off parts, and before cleaning.
- 15) For household use only. Not intended for outdoor use.
- 16) Do not attempt to move the pressure cooker when it is operating under pressure or containing hot liquids.
- 17) This appliance cooks under pressure. Improper use may result in scalding injuries. Make certain the lid is properly closed before operating. **Caution:** To reduce the risk of electric shock, cook only in removable containers. **See "Getting Started" pages 12-14.**
- 18) Use of accessories and parts that are not branded Instant Pot® nor recommended by the Instant Pot® Company may cause the cooker to malfunction. Cook only in Instant Pot® stainless steel or ceramic non-stick inner pots for best results. Other brands may not have the correct curvature to match the heating element.
- 19) Be aware that certain foods, such as applesauce, cranberries, pearl barley, oatmeal or other cereals, split peas, noodles, macaroni, rhubarb, or spaghetti can foam, froth, sputter, and clog the steam release. These foods should not be cooked under pressure cooking settings unless as directed in Instant Pot® cooker recipes.



Important Safeguards



- 20) Always check the steam release valve, float valve and anti-block shield for clogging before use.
- 21) Always make sure the sealing ring rack is completely set in the groove on the inside of the sealing ring.



When in operation or releasing pressure **DO NOT** place unprotected skin over the steam release valve.



Do not move cooker when it is in operation



Do not force lid open when the float valve is **UP**.
Make sure the float valve is **DOWN** when you open the lid.



Important Safeguards



WARNING: Spilled food can cause serious burns. Keep appliance and cord away from children. Never drape cord over edge of counter, never use power outlet below counter, and never use with an extension cord.

Special Cord Set Instructions

As per UL safety requirements, a short power supply cord (0.6 m to 0.9 m) is provided to reduce the hazards resulting from entanglement and tripping.

This appliance has a 3-prong grounding plug. To reduce the risk of electric shock, plug the power cord into a grounded (earthed) electrical outlet that is easily accessible.

Specifications

Model	Power Supply	Rated Power	Volume	Inner Pot Dimensions	Product Dimensions	Weight
DUO Mini	120V~ 60Hz	700 W	3 quart	19.8x12.7cm 7.8x5 in.	29x25.5x28.5 cm 11.4x10x11.2 in.	3.9 kg 8.6 lbs
IP-DUO60 V3		1000 W	6 quart	15.7x 23.9cm 6.2 x 9.4 in.	33 x 31 x 32 cm 13 x 12.2 x 12.6 in.	6.75 kg 14.8 lbs
IP-DUO80 V2		1200 W	8 quart	17.5 x 26.4 cm 6.9 x 10.4 in	37.6 x 33.8 x 36.1 cm 14.8 x 13.3 x 14.2 in	8.21 kg 18 lbs



Please read this manual carefully and retain for future reference.

Overview

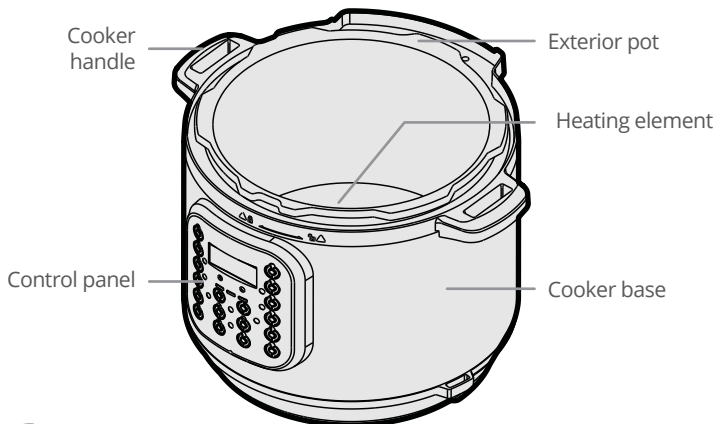
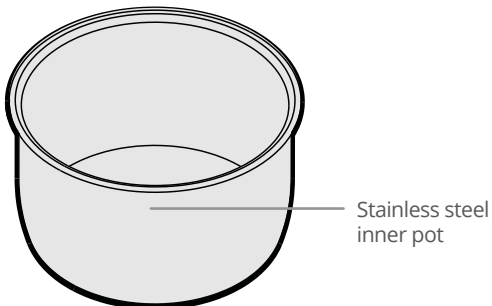
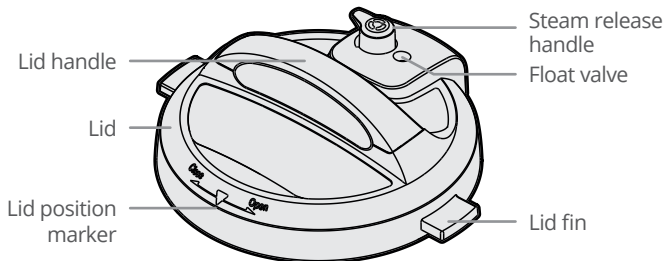

Anti-block shield

To install:

Position the anti-block shield in place and push down

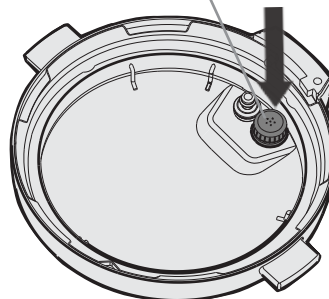

To remove:

Using your thumb, push the side of the anti-block shield towards the lid rim and lift up with some effort. The anti-block shield should pop out

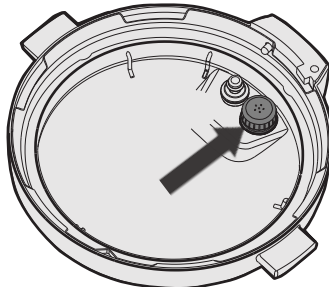

Control and Features

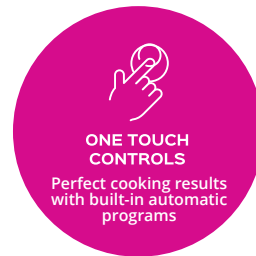

Control Panel for the DUO Series

The control panel of your Instant Pot® DUO Mini/60/80 consists of a LED display, cooking program keys, operation keys, +/- keys to adjust time, and a **Keep Warm** and **Cancel** key.



Note that the Duo Mini does not have the Poultry and Multigrain programs.



Control and Features

Control Panel for the DUO Series

Instant Pot® is a programmed smart cooker that has preset cooking times for different food ingredients and cooking methods. It also remembers your most recent settings per cooking program for a more personalized cooking experience. To return to the factory default settings, press **Cancel** to return the cooker to standby mode displaying OFF, 1) for individual cooking programs reset, press and hold the cooking program key until the cooker beeps, or 2) for global reset, press and hold the **Cancel** key until the cooker beeps.



The **Pressure Level** key has no effect on non-pressure cooking programs: **Slow Cook**, **Sauté** and **Yogurt**.

Control and Features







**THIS COOKER
IS SMART!**
Remembers your
personal preferences

Cooking Program Options

Programs	Modes	Suggested Uses	Notes for Users
Soup Broth	Less	Soup without meat.	The soup/broth remains clear due to lack of boiling motion under pressure cooking.
	Normal	Soup with meat.	
	More	Rich bone broth.	
Meat Stew	Less	Soft texture.	Choose different modes based on the meat texture desired.
	Normal	Very soft texture.	
	More	Fall-off-the bone meat texture.	
Bean Chili	Less	Less soft texture.	Choose different modes based on the bean texture desired.
	Normal	Soft texture.	
	More	Very soft texture.	
Poultry ¹	Less	Soft texture.	Choose different modes based on the meat texture desired.
	Normal	Very soft texture.	
	More	Fall-off-the-bone texture.	
Slow Cook	Less	Corresponds to Low setting in some temperature controlled slow cookers.	Non-pressure cooking program. You may also use the Instant Pot® glass lid as an option.
	Normal	Corresponds to Medium setting in some temperature controlled slow cookers.	
	More	Corresponds to High setting in some temperature controlled slow cookers.	



Control and Features

Cooking Program Options

Programs	Modes	Suggested Uses	Notes for Users
 Rice	Less	Al dente white rice.	Automated cooking program. LED displays 'Auto'. The +/- keys will not work in this program.
	Normal	Normal texture white rice.	
	More	Softer texture white rice.	
 Multigrain ¹	Less	Wild rice, brown rice, mung beans, etc.	Choose different modes based on the type of grains and the desired texture.
	Normal	Wild rice, brown rice, mung beans, etc.	
	More	Tough grains or a mixture of grains and beans.	Program includes 45 minutes of warm water soaking time prior to 60 minutes of pressure cooking.
 Porridge	Less	Oatmeal.	DO NOT use Quick Release as thick liquid will spatter out and block the steam release valve. See page 17.
	Normal	White rice porridge/congee.	
	More	Rice porridge/congee with various rices and beans.	
 Steam	Less	Vegetables.	Use the steam rack provided to elevate food above the water. Use Quick Release method to prevent food from overcooking.
	Normal	Fish and Seafood.	
	More	Meat.	
 Sauté (Brown)	Less	Simmering, thickening and reducing liquids.	NEVER have the lid on when sautéing. Maximum time is 30 minutes as a safety precaution.
	Normal	Pan searing.	
	More	Stir-frying or browning meat.	

Control and Features

Cooking Program Options

Programs	Modes	Suggested Uses	Notes for Users
 Yogurt	Less	Jiu Niang, a sweet fermented glutinous rice dessert.	Default fermentation time is 24:00 hours. You can adjust time based on your recipe.
	Normal	Fermenting milk when making yogurt.	'Yogt' will be displayed on the screen when completed.
	More	Pasteurizing milk when making yogurt.	'boiL' will be displayed on the screen.
 Pressure Cook	Less	Manual programming of pressure level and cooking time according to your favourite recipes or cooking habits.	Press the Pressure Level key to adjust pressure levels and the + / - keys to change cooking time.
	Normal		
	More		

¹ *Poultry and Multigrain cooking programs are not available on Duo Mini.*

Pressure Cooking Programs:

Working Pressure:

Low Pressure: 5.8 - 7.2 psi (40 - 50 kPa); High Pressure: 10.2 - 11.6 psi (70 - 80 kPa)

Pressure Release Pressure Limit: 15.22psi (105kPa)

Working Temperature: 115°C - 118°C (239°F ~ 244°F)

Non-Pressure Cooking Programs:

Keep Warm function: 63 - 78°C (145 ~ 172°F);

Slow Cook function: Less mode: 82-87.8°C / 180-190°F; Normal mode: 87.8-93°C / 190-200°F;

More mode: 93-99°C / 200-210°F;

Sauté function: Less mode: 135 -150°C (275 -302°F); Normal mode: 160 -176°C (320 -349°F);

More mode: 175 - 210°C (347 - 410°F)

Getting Started

- 1 Read warning cards and warning labels. Remove all packaging materials and removable warning cards from the cooker and accessories.
- 2 Clean the inner pot, lid and accessories with water and detergent before the first use.
- 3 Install the condensation collector at the rear of the cooker by aligning the top of the collector with the guides on the cooker and press in.



- 4 Place the steam release handle on the lid.







The steam release handle does not lock tight into the lid but will fit loosely.

Getting Started

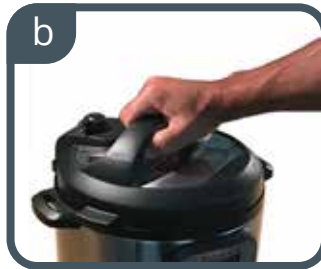
Before using your Instant Pot®:

- 1 To remove the lid, hold the handle, turn the lid counterclockwise and lift.



- 2 Remove the inner pot from the cooker.
 - 3 Add food and liquids to the inner pot as the recipe directs. If required, place the steam rack on the bottom of the inner pot first. Always add at least 18 fl oz / 500 mL of liquid for minimum liquid requirement. See “Cooking and Safety Tips” on page 22.
 - 4 Wipe the outside of the inner pot dry. Make sure there is no food debris on the bottom side of the inner pot nor on the cooking element.
 - 5 Put the inner pot back into the cooker. Rotate slightly to ensure that it is seated correctly.
 - 6 Make sure the sealing ring is completely set in the groove on the inside of the sealing ring. Ensure there is no deformation on the sealing ring rack. Do not attempt to repair a deformed ring rack. Please contact the customer care team.
-  7 To place lid, reverse Step 1. Place the lid on the cooker, align the ▼ mark on the lid with the  ▲ (**unlock**) mark and turn clockwise to the ▲  (**lock**) mark.

Getting Started



- Make sure the steam release valve, float valve and anti-block shield are clean and free of debris.
- After putting the lid on, make sure the float valve on lid top drops down.
- Do not put the lid on for the **Sauté** program.



Initial Test Run

To familiarize yourself with the Instant Pot® and check if the cooker is working properly:

- 1 Add 3 measuring cups of water into the inner pot (~25 fl oz / 750 mL).
- 2 Close the lid. Turn the steam release handle to **Sealing** position.
- 3 Press the **Steam** button and press the + / - keys to adjust time to 2 minutes.



The preheating cycle will start **after 10 seconds** and the cooker with display **On**. Traces of steam will release until the float valve pops up. The **Steam** program will begin when working pressure is reached. After the cooking cycle has completed, the cooker will beep and switch to **Keep Warm** mode if the **Auto Keep Warm** function is **ON**.

If you have any questions or concerns, please refer to the troubleshooting guide on pages 24 - 26, or call the customer care team. Contact information on page 24.

Pressure Cooking

The following are all pressure cooking programs: **Soup/Broth, Meat/Stew, Bean/Chili, Poultry¹, Rice, Multigrain¹, Porridge, Steam, and Pressure Cook.**



- Do not fill the inner pot more than 2/3 full. For food that expands during cooking such as rice or dried vegetables, do not fill the inner pot more than 1/2 full.
- After the cooking process has started, you can press **Cancel** at any time to end the program. The cooker then goes to standby mode.

- 1 Follow the steps in “Getting Started” pages 12 - 14.
- 2 Position the steam release handle to **Sealing**.



- 3 Connect the power cord. The LED displays **OFF**, indicating that the cooker is in standby mode.
- 4 Select a pressure cooking program: **Soup/Broth, Meat/Stew, Bean/Chili, Poultry¹, Rice, Multigrain¹, Porridge, Steam, or Pressure Cook.**



¹ Poultry and Multigrain cooking programs are not available on DUO Mini.

Pressure Cooking



- 5 Optionally, personalize pressure cooking programs as follows:

To do this	Press this button...	Followed by these steps...
Change the cooking time	Cooking Program Key	Select between three preset cooking times, Less , Normal and More by pressing the cooking program key repeatedly
	+ / -	Add/subtract time; press and hold for faster changes
Change the cooking pressure	Pressure Level	Select either High or Low
Set the delayed cooking time	Delay Start	<ol style="list-style-type: none"> 1. Use the + / - buttons to set the hours 2. Press Delay Start again 3. Use the + / - buttons to set the minutes

- 6 10 seconds after choosing the settings, the cooker beeps 3 times and displays **On** to indicate that the cooker has entered preheating cycle. If using **Delay Start**, the **Delay Start** light indicator will light up and 10 seconds later, the delay timer will start to count down. When count down is finished, cooking will start and LED will display **On** for the preheating cycle. Depending on the amount of food and its temperature, the preheating cycle can last from a few minutes to 40 minutes or more . As the cooker heats up and pressure builds, the float valve rises. When working pressure is reached, the cooker enters the pressure cooking cycle and displays the remaining cooking time.

When the cooking cycle has finished, the cooker beeps and enters the **Keep Warm** mode if the **Auto Keep Warm** function is turned **ON**. The LED displays the elapsed time (such as **L0:02**). If **Cancel** is not pressed, the cooker will turn **OFF** after 10 hours.



**Users can switch Auto Keep Warm ON/OFF, adjust pressure level and cooking time at any time during the cooking process.

Pressure Cooking



- 7 Release the pressure using one of the following methods (refer to recipe):

Natural Release: Allow the cooker to cool down naturally until the float valve drops down. This may take 10 to 40 minutes, or even more, depending on the amount of food in the cooker. Place a wet towel on the metal part of the lid to speed up cooling (do not cover the steam release).

Quick Release: Turn the steam release handle to the **Venting** position to let steam out until the float valve drops down. Never pull out the steam release handle while releasing steam, as escaping steam is extremely hot and can cause scalding. When cooking food with large liquid volume or starch content, immediately turn the steam release handle back to the Sealing position at the first sign of spattering. Quick Release should **ALWAYS** be closely attended.



Do not place hand over steam release valve



Do not lean face over cooker when it is in operation or releasing steam/pressure

- 8 Press **Cancel**. The LED displays **OFF**, indicating that the cooker is in standby mode. Open the lid. **Make sure the float valve is down before opening the lid.**

Non-Pressure Cooking



The following are all non-pressure cooking programs: **Sauté**, **Slow Cook**, **Yogurt** and **Keep Warm**.

Sauté

- 1 Connect the power cord. The LED displays **OFF**, indicating that the cooker is on standby.
- 2 Select the **Sauté** program.
- 3 To change the cooking temperature, press **Sauté** key repeatedly to toggle between **Less** (for simmering or thickening sauce), **Normal** (for regular browning), and **More** (for stir-frying or blackening meat).

10 seconds after choosing the settings, the cooking process will start. The cooker will beep 3 times and the LED displays **On** to indicate that the cooker has entered the preheating cycle. When the working temperature is reached, the LED displays **Hot**.



- 4 Add food to the inner pot and sauté.
- 5 When you have finished sautéing the food, press **Cancel**. The LED displays **OFF**, indicating that the cooker is in standby mode.



- Do not use the pressure cooker lid during **Sauté** program. There will be warning alerts and the display will flash. A glass lid with a venting hole may be used.
- As a safety precaution, the cooker automatically enters standby mode after 30 minutes if you have not pressed **Cancel**.

Non-Pressure Cooking



Slow Cook

- 1 You may use the Instant Pot® glass lid as an option. If using the pressure cooking lid, make sure the steam release handle is turned to **Venting**.



- 2 Connect the power cord. The LED displays **OFF**, indicating that the cooker is on standby.
- 3 Select the **Slow Cook** program. Optionally, modify the slow cooking program as follows:

To do this	Press this button...	Followed by these steps...
Change the cooking time	+ / -	Add / subtract time
Change the cooking temperature	Cooking Program Key	Select between three preset cooking temperatures, Less , Normal and More by pressing the cooking program key repeatedly
Set the delayed cooking time	Delay Start	1. Use the + / - buttons to set the hours 2. Press Delay Start again 3. Use the + / - buttons to set the minutes

10 seconds after choosing the settings, the cooking program will start. The cooker will beep 3 times and the cooker will enter the cooking cycle. The LED will display the remaining cooking time. If using **Delay Start**, the light indicator will light up and 10 seconds later, the delay timer will start to count down. Cooking begins when count down is finished.

Non-Pressure Cooking

- 5 When the cooking cycle has finished, the cooker will beep and enter the **Keep Warm** mode if the **Keep Warm** program is turned **ON**. The LED will display the elapsed time (such as **L0:02**). If **Cancel** is not pressed, the cooker will turn **OFF** after 10 hours.
- 6 If the lid is on, remove it by turning counterclockwise and lifting.
- 7 Press **Cancel**. The LED displays **OFF**, indicating that the cooker is in standby mode.

Yogurt

- 1 Pasteurize Milk
 - a) Add milk to the inner pot.
 - b) Select the **Yogurt** program.
 - c) Press the **Yogurt** key repeatedly to select the **More** mode. 10 seconds after choosing the settings, the heating process will begin. The cooker will beep 3 times and the LED will display **boiL**.
 - d) When finished, the cooker will beep and the LED will display **Yogt**.



If making yogurt in smaller containers: add 1 cup/250 ml of water to the inner pot, place the steam rack in the inner pot and put the containers on top of the steam rack, close the lid, select the **Steam** program and use the **+ / -** buttons to set time to 2 minutes. Make sure the steam release handle is in **Sealing** position when running the **Steam** program as this is a pressure cooking program. When complete, use the natural release method (page 17) and continue with steps 2 to 4.

*The advantages of pasteurizing milk are to 1) kill pathogens and harmful bacteria, and 2) denature milk proteins for easier absorption by the body.

Non-Pressure Cooking

2 Cool Milk

- Remove the inner pot and place it on a wire rack.
- Allow the milk to cool to 115°F/46°C. Test the milk temperature with a thermometer.

3 Add Starter Culture

- Add starter culture to the warm milk in the inner pot.
- Replace the inner pot and close the lid.



The steam release handle can be left in **Venting** or **Sealing** position.

4 Ferment Yogurt

- Select the **Yogurt** program and adjust to **Normal** mode.
- Press **+ / -** to set fermentation time.
- When finished, the cooker will beep and the LED will display **Yogt**.



Cooking and Safety Tips



- Extreme caution should be taken when moving the steam release handle to the **Venting** position. Keep hands and face away from the steam release openings. Failure to comply may result in scalding or serious injury.
- Do not attempt to open the lid until pressure inside the cooker is completely released. As a safety feature, until the float valve drops down the lid is locked and cannot be opened. **Do not force lid open.**
- When opening the lid, the inner pot may adhere to the lid. This is caused by vacuum due to cooling. Make sure the steam release handle is in the **Venting** position and all the steam is released.
- If the float valve is stuck, move the steam release handle to the **Venting** position. Once all the steam is released, push the float valve down with a pen or long utensil.
- Always add at least 18 fl oz. / 500 ml of water or other liquids so enough steam can be generated to cook under pressure. These include cooking sauces, wine, beer, stocks, juices of fruits and vegetables. Oils, oil-based sauces and thick cooking sauces do not have enough water content and will not account for the required liquid volume.
- Time to pressure and cooking time will vary according to the temperature and quantity of the ingredients. Food that is cold or frozen will take longer to cook than food that is at room temperature.
- When using the **Delay Start** program, allow sufficient cooling down time before serving.
- The **Delay Start** program is not recommended for porridge, oatmeal or other foamy and thick liquids. Cooking progresses should be monitored when cooking these foods.

Care and Cleaning



Unplug your Instant Pot® and let it cool to room temperature before cleaning.

- **All Instant Pot® inner pots, pressure cooker lids, glass lids, and accessories are dishwasher safe.**
- Remove the inner pot and lid, and wash with detergent. Rinse with clear water and wipe dry with a soft cloth.
- Wipe the inner cooker base rim and slot with dry cloth to prevent rusting of the exterior cooker rim.
- Remove the sealing ring and anti-block shield from the underside of the lid. Wash with warm, soapy water, rinse with clear water and wipe dry with a soft cloth.
- **The sealing ring must always be properly positioned on the underside of the lid.**
- Clean the outer body with a damp soft cloth or sponge.
- Never use harsh chemical detergents, scouring pads or powders on any of the parts or components.
- Periodically check that the steam release valve and float valve are in good working order and free of debris.

Troubleshooting

If you experience any problems with the cooker, need technical assistance or product return information, please contact the Instant Pot support team using the methods below:

- Create a support ticket: www.InstantPot.com/support/
- Email: support@instantpot.com
- Call 1-800-828-7280 ext 2 for the customer care team.

You can also find tips, videos and FAQs on www.InstantPot.com/faq/

The issues in the following tables do not always indicate a faulty cooker. Please examine the cooker carefully before contacting the support team.

Problem	Possible reason	Solution
Difficulty with closing the lid	Sealing ring not installed properly	Position the sealing ring
	Float valve in the popped-up position	Slightly press the float valve downward
Difficulty with opening the lid	Pressure inside the cooker	Position the steam release handle to the venting position to release the internal pressure. Open the lid after the pressure is completely released
	Float valve stuck at the popped-up position due to debris or stickiness from food	Ensure steam is completely released by turning steam release handle to Venting position, Press the float valve lightly with a long utensil. Open the lid cautiously and clean the float valve and lid before the next use.

1

2

Troubleshooting

Problem	Possible reason	Solution
3 Steam leaks from the side of the lid	No sealing ring	Install the sealing ring
	Sealing ring damaged	Replace the sealing ring
	Food debris attached to the sealing ring	Clean the sealing ring
	Lid not closed properly	Open then close the lid again
4 Steam leaks from float valve for over 2 minutes	Food debris on the float valve silicone seal	Clean the float valve silicone seal
	Float valve silicone ring worn- out or missing	Replace the float valve silicone ring
5 Float valve unable to rise	Too little food or water in inner pot	Add water according to the recipe
	Float valve obstructed by the lid locking pin	Close the lid completely, see "Getting Started" section
6 Steam comes out from the steam release valve non-stop	Steam release valve not in sealing position	Turn the steam release handle to the sealing position
	Pressure control fails	Contact support
7 Display flashes "Lid"	Lid is not in the correct position for the selected program	Close the lid for pressure cooking or open the lid for sautéing
8 Display remains blank after connecting the power cord	Bad power connection or no power	Inspect the power cord to ensure a good connection, check if the power outlet is active
	Cooker's electrical fuse has blown	Contact support

Troubleshooting

Problem		Possible reason	Solution
All LEDs flash with a code appearing on screen and the warning beep is ON	C1	Faulty temperature sensor	Contact support
	C2	Faulty temperature sensor	Contact support
	C5	Temperature is too high because inner pot is not placed into the cooker base	Insert the inner pot properly
		Temperature is too high because there is no water in inner pot	Put food and water in the inner pot
	C6	Faulty pressure sensor	Contact support
	C6H	Faulty HIGH pressure sensor	
	C6L	Faulty LOW pressure sensor	
Rice is half cooked or too hard		Too little water	Adjust dry rice and water ratio according to recipe
		Lid opened too early	After cooking cycle completes, leave the lid on for 5 more minutes
Rice is too soft		Too much water	Adjust dry rice and water ratio according to recipe
The cooker beeps 5 times and displays 'burn' message after the cooking program started.		Indication of overheating. The cooker has reduced the heating temperature, and may not reach cooking pressure	Starch deposits at the bottom of the inner pot might have clogged heat dissipation. Stop the cooker and inspect the bottom of the inner pot
Occasional ticking or light cracking sound		The sound of power switching and expanding pressure board when changing temperature	This is normal
		Bottom of the inner pot is wet	Wipe bottom of the inner pot dry before cooking

9

10

11

12

13

Warranty

Limited Warranty

This Limited Warranty is effective for one year from the date of original consumer purchase. Proof of original purchase date and, if requested by an authorized Instant Pot Company (“IPC”) representative, return of your appliance as IPC may direct at IPC’s expense, is required to obtain service under this Limited Warranty.

When this appliance is operated and maintained in accordance with written instructions attached to or furnished with the product, Instant Pot Company will pay for either (i) repair labor to correct defects in materials or workmanship that existed when this appliance was purchased or (ii), at its sole and exclusive discretion, replace the appliance for a period of one (1) year from the date of purchase. In the event that your appliance is replaced, the Limited Warranty on the replacement appliance will expire at the original date (i.e. 12 months from the original purchase date).

This Limited Warranty extends only to the original purchaser and use of the appliance in the United States of America and Canada. This warranty does not cover units that are used outside of the United States of America and Canada.

Any modification or attempted modification to your appliance may interfere with the safe operation of the appliance and will void this Limited Warranty. This Limited Warranty does not apply in respect of any appliance or any part thereof that has been altered or modified from its factory settings unless such alterations or modifications were expressly authorized by an IPC representative.

IPC is not responsible for shipping costs related to warranty service, save and except for shipping costs associated with the return of your appliance as provided herein.

Limitation and Exclusions

The liability of IPC, if any, for any allegedly defective appliance or part shall in no circumstances exceed the purchase price of a comparable replacement appliance.

This Limited Warranty does not cover:

1. Damage resulting from accident, alteration, misuse, abuse, neglect, unreasonable use, use contrary to the operating instructions, normal wear and tear, commercial use, improper assembly, disassembly, failure to provide reasonable and necessary maintenance, fire, flood, acts of God or repair by anyone unless directed by an Instant Pot Representative.
2. Repairs where your appliance is used for other than normal, single-family household use or when it is used in a manner that is contrary to published user or operator instructions.
3. Use of unauthorized parts and accessories, or repairs to parts and systems resulting from unauthorized repairs or modifications made to this appliance.

The cost of repair or replacement under these excluded circumstances shall be borne by you.

Warranty

Disclaimer of Implied Warranties

IMPLIED WARRANTIES, INCLUDING ANY WARRANTIES OF MERCHANTABILITY OR IMPLIED WARRANTY OF FITNESS FOR A PARTICULAR PURPOSE, ARE HEREBY LIMITED TO ONE YEAR OR THE SHORTEST PERIOD ALLOWED BY LAW. Some states or provinces do not allow limitations to the duration of implied warranties of merchantability or fitness, so this limitation may not apply to you.

Disclaimer of Representations Outside of Warranty

IPC makes no representation about the quality, durability, or need for service or repair of this appliance other than the representations contained in this warranty.

Limitation of Remedies; Exclusion of Incidental and Consequential Damage

YOUR SOLE AND EXCLUSIVE REMEDY UNDER THIS LIMITED WARRANTY SHALL BE PRODUCT REPAIR OR REPLACEMENT AS PROVIDED HEREIN. IPC SHALL NOT BE LIABLE FOR INCIDENTAL OR CONSEQUENTIAL DAMAGES ARISING OUT OF OR IN CONNECTION WITH THE USE OR PERFORMANCE OF THE APPLIANCE OR DAMAGES WITH RESPECT TO ANY ECONOMIC LOSS, PERSONAL INJURY, LOSS OF PROPERTY, LOSS OF REVENUES OR PROFITS, LOSS OF ENJOYMENT OR USE, COSTS OF REMOVAL, INSTALLATION OR OTHER CONSEQUENTIAL DAMAGES OF WHATSOEVER NATURE.

You the buyer may have other rights and remedies under your state's or province's applicable laws, which are in addition to any right or remedy which may be available under this limited warranty.

Warranty Registration and Service

Please visit <http://instantpot.com/support/register/> to register your new Instant Pot and validate your warranty within thirty (30) days of purchase. You will be asked to provide the store name, date of purchase and model number (found on the base of your cooker) along with your name and address. The registration will enable us to keep you up to date with product developments, recipes and contact you in the unlikely event of a product safety notification. By registering, you acknowledge to have read and understood the instructions for use, and warnings set forth in the accompanying instructions.

To obtain service under this warranty, please call the Customer Care Team at 1-800-828-7280. If IPC is unable to resolve the problem, you may be asked to send your appliance to the Appliance Service Department for quality inspection. IPC is not responsible for shipping costs related to warranty service, save and except for shipping costs associated with the return of your appliance from Canada or within the 48 contiguous states and the District of Columbia of the United States of America, as provided herein. When returning your appliance, please include your name, address, phone number, proof of the original purchase date as well as a description of the problem you are encountering with the appliance.

Instant Pot® Company
11 - 300 Earl Grey Dr. Suite 383
Ottawa, Ontario
K2T 1C1
Canada

Telephone: +1-800-828-7280 ext 2

Fax: +1-613-800-0726

Web: www.InstantPot.com

US and Canada E-mail: support@instantpot.com

To enhance your experience with Instant Pot, join the official Instant Pot Community

 [Facebook.com/groups/instantpotcommunity](https://www.facebook.com/groups/instantpotcommunity)

 twitter.com/instantpot



Instant Pot® Free Recipe App & More

Copyright© Instant Pot® Company

Instant Pot®