



# User Manual Microwave

# Manuel D'utilisateur Micro-onde

MODEL | MODÈLE:  
CHM7MB, CHM7MW, CHM7MS



# CONTENTS

## SAFETY INFORMATION

Precautions to Avoid Possible Exposure to Excessive Microwave Energy.....	4
A Special Note on Arcing .....	4
Addendum.....	4
Important Safety Instructions .....	5
Grounding Instructions.....	7
Utensil Guide for the Microwave.....	8-9

## SET UP & USE

Specifications.....	10
Installation Guide .....	10
Parts & Features .....	11
Control Panel.....	11
Operation.....	12-17

## CLEANING & CARE.....18

## TROUBLESHOOTING & WARRANTY

Before You Call For Service .....	19
Customer Service.....	19
Troubleshooting .....	20
Limited Warranty .....	21

1. READ these instructions carefully before installing and operating the appliance. Keep them for further reference.
2. Record in the space below the "SERIAL/MODEL NUMBER" found on the back or bottom of your appliance and retain this information for future reference.

SERIAL NUMBER:

MODEL NUMBER:

DATE OF PURCHASE:

Save and staple your sales receipt to your manual for warranty coverage.

# SAFETY INFORMATION



## DANGER

**DANGER** - Immediate hazards which **WILL** result in severe personal injury or death



## WARNING

**WARNING** - Hazards or unsafe practices which **COULD** result in severe personal injury or death



## CAUTION

**CAUTION** - Hazards or unsafe practices which **COULD** result in minor personal injury

## PRECAUTIONS TO AVOID POSSIBLE EXPOSURE TO EXCESSIVE MICROWAVE ENERGY

1. Do not attempt to operate this oven with the door open since open-door operation can result in harmful exposure to microwave energy. It is important not to defeat or tamper with the safety interlocks.
2. Do not place any object between the oven front face and the door or allow soil or cleaner residue to accumulate on sealing surfaces.
3. Do not operate the oven if damaged. It is particularly important that the oven door closes properly and that there is no damage to the:
  1. DOOR (bent)
  2. HINGES AND LATCHES (broken or loosened)
  3. DOOR SEALS AND SEALING SURFACES
4. The oven should not be adjusted or repaired by anyone except properly qualified service personnel.

## A SPECIAL NOTE ON ARCING

“Arcing” refers to the presence of sparks inside the microwave oven.

It can be caused by:

- Metal or foil touching the inside walls of the oven.
- Foil not closely molded to food, where edges have been left sticking up.
- Small metal parts such as twist-ties, poultry pins, or gold-rimmed dishes.
- Recycled paper towels which may contain small amounts of metal.



## CAUTION

IF YOU SEE SPARKS IN YOUR MICROWAVE OVEN, IMMEDIATELY TURN TIMER TO OFF, CEASE COOKING AND CORRECT THE PROBLEM.

## ADDENDUM

If this product is not maintained in a good state of cleanliness, its surface could be degraded. This could affect the lifespan of the product and lead to a dangerous situation.

## SAFETY INFORMATION

# IMPORTANT SAFETY INSTRUCTIONS

## **WARNING**

When using electrical appliances, basic safety precautions should be followed, including the following  
**WARNING:** To reduce the risk of burns, electric shock, fire, and injury to persons or exposure to excessive microwave energy:

1. Read all instructions before using the appliance.
2. Read carefully and follow the specific **“Precautions to avoid possible exposure to excessive microwave energy”**.
3. This appliance must be grounded. Connect only to properly grounded outlet. See “GROUNDING INSTRUCTIONS”.
4. Install or position this appliance only in accordance with the provided installation instructions.
5. Some products such as whole eggs and sealed containers -for example, closed glass jars- can potentially explode and should not be heated in this oven.
6. Use this appliance only for the intended uses as described in this manual. This type of oven is specifically designed to heat, cook, or dry food. It is not designed for industrial or laboratory use. Do not use corrosive chemicals or vapors in this appliance.
7. As with any appliance, close supervision is necessary when used by children.
8. To reduce the risk of fire in the oven cavity;
  - Do not overcook food. Carefully tend to the appliance when paper, plastic, or other combustible materials are placed inside the oven to facilitate cooking.
  - Remove wire twist-ties from paper or plastic bags before placing bag in oven.
  - If materials inside the oven ignite, keep oven door closed, turn oven off, and disconnect the power cord or shut off power at the fuse or circuit breaker panel.
  - Do not use the cavity for storage purposes. Do not leave paper products, cooking utensils or food inside the cavity when not in use.
9. Liquids, such as water, coffee, or tea can be overheated beyond the boiling point without appearing to be boiling due to surface tension of the liquid. Visible bubbling or boiling when the container is removed from the microwave oven is not always present. **This could result in very hot liquids suddenly boiling over when a spoon or other utensil is inserted into the liquid.**
10. Do not heat oil or fat for deep-frying. It is difficult to control the temperature of oil in a microwave oven.
11. Foods with heavy skins such as potatoes, whole squash, apples and chestnuts should be pierced with a fork or the tip of a sharp knife before cooking.

## SAFETY INFORMATION

12. The contents of feeding bottles and baby food jars should be stirred or shaken and the temperature should be checked before serving in order to avoid burns.
13. Cooking utensils may become hot because of heat transferred from the heated food. Pot holders may be needed to handle the utensil.
14. Do not cover or block any openings on the appliance.
15. Do not store or use this appliance outdoors. Do not use this product near water, for example, near a kitchen sink, in a wet basement, near a swimming pool, or similar locations.
16. Do not operate this appliance if the cord or plug is damaged, if it is not working properly, or if it has been damaged or dropped.
17. Do not immerse cord or plug in water. Keep cord away from heated surfaces. Do not let cord hang over the edge of a table or counter.
18. Use only thermometers, specifically designed for use in microwave ovens.
19. Be certain the glass tray and roller rings are in place before operating the oven
20. This appliance should be serviced only by qualified service personnel. Contact nearest authorized service facility for examination, repair, or adjustment.
21. When cleaning sealing surfaces of the oven, such as the door jamb, use only mild, nonabrasive soaps, or mild detergents applied with a sponge or soft cloth.

## SAVE THESE INSTRUCTIONS HOUSEHOLD USE ONLY

### FEDERAL COMMUNICATIONS COMMISSION RADIO FREQUENCY INTERFERENCE STATEMENT

**WARNING:** This equipment generates and uses ISM frequency energy and if not installed and used properly, that is in strict accordance with the manufacturer's instructions, may cause interference to radio and television reception. It has been type-tested and found to comply with limits for an ISM Equipment pursuant to part 18 of FCC Rules, which are designed to provide reasonable protection against such interference in a residential installation. However, there is no guarantee that interference will not occur in a particular installation. If this equipment does cause interference to radio or television reception, which can be determined by turning the equipment off and on, the user is encouraged to try to correct the interference by one or more of the following:

- Reorient the receiving antenna of radio or television.
- Relocate the Microwave oven with respect to the receiver.
- Move the microwave oven away from the receiver.
- Plug the microwave oven into a different outlet so that microwave oven and receiver are on different branch circuits.

THE MANUFACTURER is not responsible for any radio or TV interference caused by UNAUTHORIZED MODIFICATION to this microwave oven. It is the responsibility of the user to correct such interference.

# SAFETY INFORMATION

## GROUNDING INSTRUCTIONS

### ELECTRICAL REQUIREMENTS

The electrical requirements are a 120 volt 60 Hz, AC only, 20 amp. It is recommended that a separate circuit serving only the oven be provided. The oven is equipped with a 3-wire cord having a 3-prong grounding plug. It must be plugged into a wall receptacle that is properly installed and grounded.

This appliance must be grounded. In the event of an electrical short circuit, grounding reduces risk of electric shock by providing an escape wire for the electric current. The cord provided with this appliance is equipped with a grounding wire and a grounding plug. The plug must be plugged into an outlet that is properly installed and grounded. Do not attempt to tamper with this safety feature by modifying the plug in any way.

### **WARNING**

Improper use of the grounding plug can result in a risk of electric shock.

Consult a qualified electrician or serviceman if:

- 1) The grounding instructions are not completely understood.
- 2) You are unsure that the appliance is properly grounded.
- 3) You have any questions about the grounding or electrical instructions.

### POWER SUPPLY CORD

1. A short power supply cord is provided to reduce the risk of becoming entangled in or tripping over a longer cord.
2. If the power supply cord is too short, do not use an extension cord. Have a qualified electrician or serviceman install an outlet near the appliance.
3. If it is absolutely necessary to use longer cord sets or an extension cord, extreme care must be exercised.
  - a) Use only a grounding type 3-wire extension cord that has a 3-blade grounding plug and a 3-slot receptacle that will accept the plug on the appliance.
  - b) The marked electrical rating of the cord set or extension cord must be equal to or greater than the electrical rating of the appliance. The longer cord should be arranged so that it will not drape over the counter top or table top where it can be pulled on by children or tripped over unintentionally.

**NOTE:** Neither Commercial Chef nor the dealer can accept any liability for damage to the oven or personal injury resulting from failure to observe the electrical connection procedures.

# SAFETY INFORMATION

## UTENSIL GUIDE FOR THE MICROWAVE

This section lists which utensils can be used in the microwave, which have limited use, and which should not be used in the microwave at all.

CAN USE	CAN NOT USE	LIMITED USE
<ul style="list-style-type: none"><li>• <b>Microwave browning dish:</b> For browning the exterior of food such as steaks, chops, or pancakes. Follow the directions provided with your browning dish.</li><li>• <b>Microwaveable plastic wrap:</b> For retaining steam. Leave a small opening for some steam to escape. Avoid placing it directly on the food.</li><li>• <b>Paper towels and napkins:</b> To absorb excess moisture and prevent splattering. Use for short-term heating and covering. Check for manufacturer's labels for any special instructions.</li><li>• <b>Oven-proof glass, glass-ceramic bowls and dishes:</b> For use in the microwave oven.</li><li>• <b>Paper plates and cups:</b> For short-term heating at low temperatures. Do not use recycled paper, which may contain metal and could ignite.</li></ul> <p><b>NOTE:</b> Recycled paper may contain metal which could ignite so please be careful.</p>	<ul style="list-style-type: none"><li>• <b>Glass jars and bottles:</b> Regular glass is too thin to be used in a microwave. It can shatter, causing damage and injury.</li><li>• <b>Paper bags:</b> These are a fire hazard, they can absorb heat and burn. Only use popcorn bags that are designed for microwave use.</li><li>• <b>Styrofoam plates and cups:</b> These can melt and leave a harmful chemical residue on food.</li><li>• <b>Plastic storage and food containers:</b> Containers meant for cold storage, such as margarine tubs, can melt in the microwave.</li><li>• <b>Metal utensils:</b> These can damage your microwave oven. Remove all metal from food and containers before cooking.</li><li>• <b>Parchment paper:</b> Use as a cover to prevent splattering or as a wrap for steaming.</li></ul>	<ul style="list-style-type: none"><li>• <b>Aluminum foil:</b> Smooth, narrow strips of foil may be used to shield delicate areas on food items like drumsticks and wings to prevent overcooking. Keep all aluminum foil at least 1 inch from the side walls and the door of the microwave.</li></ul> <p><b>NOTE:</b> Using too much foil can damage your oven.</p> <ul style="list-style-type: none"><li>• <b>Ceramic, porcelain, and stoneware:</b> Only if they are labelled "Microwave Safe". If they are not labelled, test them to make sure they can be used safely.</li><li>• <b>Plastic:</b> Use only if labelled "Microwave Safe". Use with care because the plastic can soften from the heat of the food and some plastic can melt.</li></ul>



# SAFETY INFORMATION

## CAN USE

- **Wax paper:** To prevent spattering.
- **Thermometers:** Only those labelled “Microwave Safe” and follow all directions. Check the temperature of food in several places. Conventional thermometers may be used on microwaved food once the food has been removed from the oven.

## CAN NOT USE

- **Aluminium tray:** May cause arcing. Avoid aluminum foil this may cause arcing.
- **Take-out carton with metal handle:** May cause arcing. Transfer food to a microwave-safe container.
- **Metal or metal-trimmed utensils:** Metal cookware, metal trim, and metallic glazes may cause arcing. Also avoid metal skewers and metal twisties.
- **Wood:** Wood will dry out when used in the microwave oven and may split or crack. Wooden bowls, baskets and board will dry out and may split or crack when used in the microwave.
- **Recycled paper towels, paper plates and cups:** May contain metal and could ignite.

**NOTE:** To test if a dish is safe for microwaving, place the empty dish in the oven and microwave on HIGH for 30 seconds. A dish which becomes very hot should not be used.

## LIMITED USE

- **Straw, wicker, and wood:** For short-term heating, such as warming dinner rolls for a few seconds. Baskets and bowls may be flammable.

# SET UP & USE

## SPECIFICATIONS

- Power Consumption: 120V-60Hz, 1050W
- MWO Power: 700W
- Operation Frequency: 2450MHz
- Outside Dimensions (H x W x D): 10.2" x 17.3" x 12.5" for B and W model  
10.2" x 17.3" x 14.1" for Stainless model
- Oven Cavity Dimensions (H x W x D): 8.1" x 12" x 12"
- Oven Capacity: 0.7 cubic feet
- Net Weight: Approx. 20.2 lbs.

## INSTALLATION GUIDE

1. Make sure that all the packing materials are removed from the inside of the door.
2. Check the oven for any damage, such as misaligned or bent door, damaged door seals and sealing surfaces, broken or loose door hinges and latches, and dents inside the cavity or on the door. If there is any damage, do not operate the oven. Contact qualified service personnel.
3. This microwave oven must be placed on a flat, stable surface capable of supporting the weight of the oven plus the heaviest food likely to be cooked in the oven.
4. Do not place the oven where heat, moisture, or high humidity are generated, or near combustible materials.
5. To function correctly, the oven must have sufficient airflow on all sides. Allow 8" of space above the oven, 4" at back, and 2" at both sides. Do not cover or block any openings on the appliance. Do not remove feet on which oven stands.
6. Do not operate the oven without glass tray, roller support, and shaft in their proper positions.
7. Make sure that the power supply cord is undamaged and does not run under the oven or over any hot or sharp surface.
8. The socket must be readily accessible so that the cord can be quickly reached and easily unplugged in an emergency.

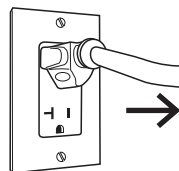

**NOTE:** Do not remove the mica plate covering the wave guide in the oven cavity.

## RADIO OR TV INTERFERENCE

If the microwave oven causes interference to your radio or TV,

1. Check that the microwave oven is on a different circuit
2. Relocate the radio or TV as far away from the oven as possible
3. Check position and signal of receiving antenna.
4. Clean door and sealing surface.
5. Move the microwave oven far away from the receiver.

# SET UP & USE

## PARTS & FEATURES

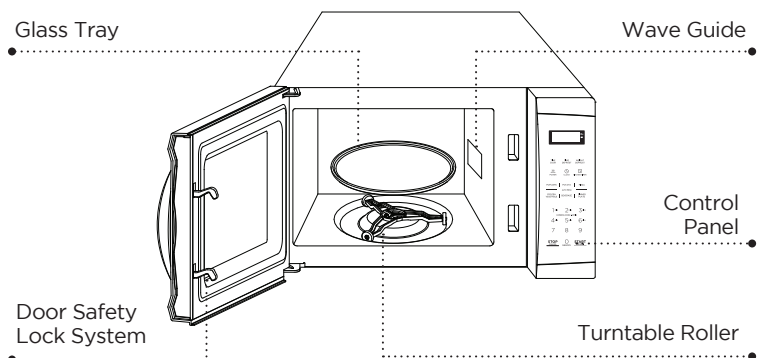

**NOTE:** Do not remove the mica plate covering the wave guide in the oven cavity.

- A. Never place the glass tray upside down. The glass tray should never be restricted.
- B. Both glass tray and turntable ring assembly must always be used during cooking.
- C. All food and containers of food are always placed on the glass tray for cooking.
- D. If glass tray or turntable ring assembly cracks or breaks, contact your nearest authorized service center.

## OPERATION

### CONTROL PANEL AND FEATURES

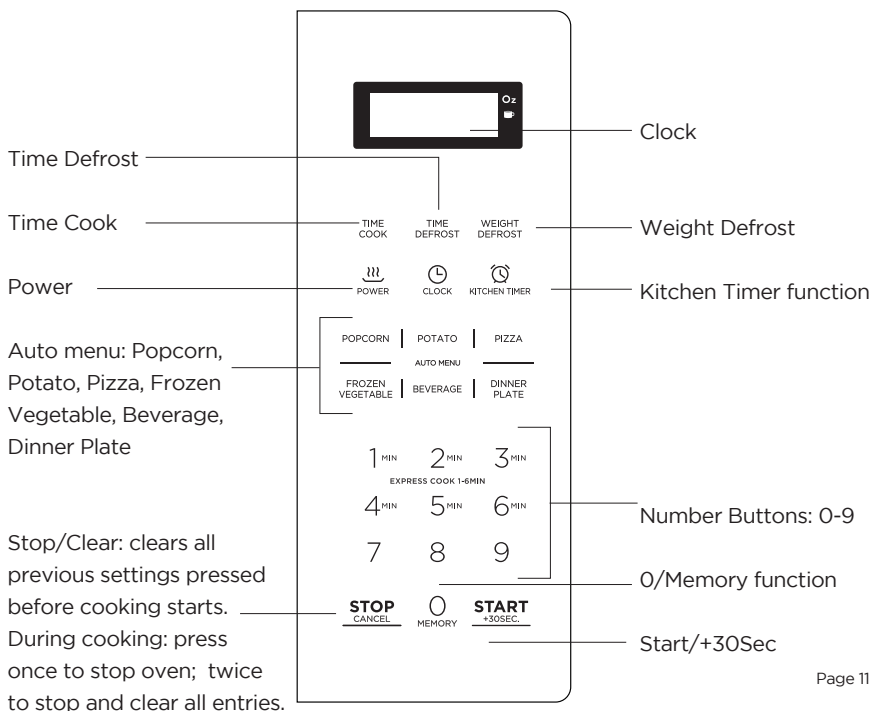

# SET UP & USE

## OPERATION

### 1. Power Level

11 power levels are available.

Level	10	9	8	7	6	5	4	3	2	1	0
Power	100%	90%	80%	70%	60%	50%	40%	30%	20%	10%	0%
Display	PL10	PL9	PL8	PL7	PL6	PL5	PL4	PL3	PL2	PL1	PL0

### 2. Clock Setting

(1) Press "CLOCK", "00:00" will display.

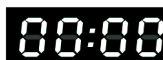

(2) Press the number keys and enter the current time. For example, time is 10:12 now, please press "1, 0, 1, 2" in turn.



(3) Press "CLOCK" to finish clock setting. ":" will flash and the clock will be lighted.

(4) If the numbers input are not within the range of 1:00--12:59, the setting will be invalid until valid numbers are input.

**NOTE:** (1) In the process of clock setting, if the "STOP/CANCEL" button is pressed or if there is no operation within 1 minute, the oven will go back to the former setting automatically.

(2) If the clock needs to be reset, please repeat step 1 to step 3.



### 3. Kitchen Timer

(1) Press "KITCHEN TIMER", LED will display 00:00, the first hour figure will flash.

(2) Press the number keys and enter the timer time. (The maximum cooking time is 99 minutes and 99 seconds.)

(3) Press "START/+30SEC." to confirm setting.

(4) When the timer has completed, the buzzer will ring 5 times.

If the clock is set (12-hour system), LED will display the current time.

**NOTE:** 1) The kitchen time is different from 12-hour system. Kitchen Timer is a timer.

2) During kitchen timer, any program cannot be set.

### 4. Microwave cook

(1) Press "TIME COOK" once, LED will display "00:00".



(2) Press number keys to input the cooking time; the maximum cooking time is 99 minutes and 99 seconds.

(3) Press "POWER" once, LED will display "PL10". The default power is 100% power. Now you can press number keys to adjust the power level.

(4) Press "START/+30SEC." to start cooking.

# SET UP & USE

**Example:** to cook the food with 50% microwave power for 15 minutes.

A. Press "TIME COOK" once. "00:00" displays.

B. Press "1", "5", "0", "0" in order.

C. Press "POWER" once, then press "5" to select 50% microwave power.

D. Press "START/+30SEC." to start cooking.

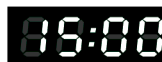

**NOTE:** 1) During this process, if the " STOP/CANCEL " button is pressed, or if there is no operation within 1 minute, the oven will go back to the former setting automatically.

2) If "PLO" selected, the oven will work with fan for no power.

3) During microwave setting, "POWER " can be pressed to change the power you need. After pressing "POWER ", the current power is displayed, now you can press number button to change the power. The oven will work with the selected power for the remaining time.

## 5. Speedy Cooking

(1) In waiting state, instant cooking at 100% power level can be started by selecting a cooking time from 1 to 6 minutes. Press "START/+30SEC." to increase the cooking time. The maximum cooking time is 99 minutes and 99 seconds.

(2) In waiting state, instant cooking at 100% power level with 30 seconds' cooking time can be started by pressing " START/+30SEC ". Each press on the same button will increase cooking time by 30 seconds. The maximum cooking time is 99 minutes and 99 seconds.

**NOTE:** During microwave cooking and time defrost, time can be added by pressing "START/30SEC." button.

## 6. Weight Defrost Function

(1) Press " WEIGHT DEFROST ", LED will display "dEF1".

(2) Press numerical buttons to input weight to be defrosted.

Input the weight ranged between 4-100 Oz.

(3) If the weight input is not within 4-100 Oz, the input will be invalid.

(4) Press " START/+30SEC. " to start defrosting and the cooking time remaining will be displayed.

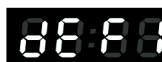

## 7. Time Defrost Function

(1) Press " TIME DEFROST ", LED will display "dEF2".

(2) Press number pads to input defrosting time. The effective time range is 0:01-99:99.

(3) The default microwave power is power level 3. If you want to change the power level, press " POWER " once, and the LED will display "PL 3", then press the number pad of the power level you require.

(4) Press " START/+30SEC. " to start defrosting. The remaining cooking time will be displayed.



## SET UP & USE

### 8. POPCORN

a) Press “POPCORN” repeatedly until the number you require appears in the display,

“1.75”, “3.0”, “3.5” Oz will display in order.

For example, press “POPCORN” once, “1.75” appears.



b) Press “START/+30 SEC.” to cook, buzzer sounds once. When cooking finishes, buzzer sounds five times and then returns to waiting state.

### 9. POTATO

a) Press “POTATO” repeatedly until the number you require appears in the display, “1”, “2”, “3” will display in order.

“1” SET : 1 potato (approximate 8.0 Oz)

“2” SETS: 2 potatoes (approximate 16.0 Oz)

“3” SETS: 3 potatoes (approximate 24.0 Oz)

For example, press “POTATO” once, “1” appears.



b) Press “START/+30 SEC.” to cook, buzzer sounds once. When cooking is completed, the buzzer sounds five times and then returns to waiting state.

### 10. FROZEN VEGETABLE

a) Press “FROZEN VEGETABLE” repeatedly until the number you require appears in the display, “4.0”, “8.0”, “16.0” oz will display in order.

For example, press “FROZEN VEGETABLE” once, “4.0” appears.



b) Press “START/+30 SEC.” to cook, buzzer sounds once. When cooking finishes, buzzer sounds five times and then returns to waiting state.

### 11. BEVERAGE

a) Press “BEVERAGE” repeatedly until the number you require appears in the display, “1”, “2”, “3” cup will display in order. One cup is about

120ml. For example, press “BEVERAGE” once, “1” appears.



b) Press “START/+30 SEC.” to cook, buzzer sounds once. When cooking finishes, buzzer sounds five times and then returns to waiting state.

### 12. DINNER PLATE

a) Press “DINNER PLATE” repeatedly until the number you require appears in the display, “9.0”, “12.0”, “18.0” oz will display in order.

For example, press “DINNER PLATE” once, “9.0” appears.



b) Press “START/+30 SEC.” to cook, buzzer sounds once. When cooking finishes, buzzer sounds five times and then returns to waiting state.

## SET UP & USE

### 13. PIZZA

- a) Press “PIZZA” repeatedly until the number you require appears in the display, “4.0”, “8.0”, “14.0” oz will display in order.

For example, press “PIZZA” once, “4.0” appears.



- b) Press “START/+30 SEC.” to cook, buzzer sounds once. When cooking finishes, buzzer sounds five times and then returns to waiting state.

### 14. MEMORY FUNCTION

- (1) Press “0/MEMORY” to choose memory 1-3 procedure. The LED will display 1,2,3.  
(2) If the procedure has been set, press “START/+30 SEC.” to use it. If not, continue to set the procedure. Only one or two stages can be set.  
(3) After finishing the setting, press “START/+30 SEC.” once to save the procedure. If press “START/+30 SEC.” again, it will start cooking.

**Example:** To program the following setting as the second memory to cook food with 80% microwave power for 3 minutes and 20 seconds.

The steps are as follows:

- a. In waiting state, press “0/MEMORY” twice, stop pressing until the screen displays “2”.  
b. Press “TIME COOK” once, then press “3”, “2”, “0” in order.  
c. Press “POWER” once, “PL10” display, then press “8” and “PL8” displays.  
d. Press “START/+30 SEC.” to save the setting. Buzzer sounds once and the LED will display “2”. If you press “START/+30SEC.” again, the procedure will be saved as the memory 2 and operated.  
e. If power is lost, the “0/MEMORY” setting will need to be reprogrammed.  
f. If you want to run the saved procedure, in waiting state, press “0/MEMORY” twice, screen displays “2”, then press “START/+30SEC.” to run.

### 15. MULTI-STAGE COOKING

At most 2 stages can be set for cooking. In multi-stage cooking, if one stage is defrosting, then defrosting shall be placed at the first stage automatically.

**Note:** Auto cooking cannot work in the multi-stage cooking.

**Example:** if you want to cook with 80% microwave power for 5 minutes + 60% microwave power for 10 minutes. The cooking steps are as following:

- (1) Press “TIME COOK” once, then press “5”, “0”, “0” to set the cooking time;  
(2) Press “POWER” once, then press “8” to select 80% microwave power.  
(3) Press “TIME COOK” once, then press “1”, “0”, “0”, “0” to set the cooking time;  
(4) Press “POWER” once, then press “6” to select 60% microwave power.  
(5) Press “START/+30 SEC.” to start cooking.

# SET UP & USE

## 16. INQUIRING FUNCTION

- (1) In cooking state, press “ CLOCK ”, the LED will display clock for three seconds.
- (2) In the microwave cooking state, press “ POWER ” to inquire microwave power level, and the current microwave power will be displayed. After three seconds, the oven will turn back to the previous state. In multi-stage state, the inquiring way can be done by the same way as above.

## 17. CHILD LOCK FUNCTION

Lock: In waiting state, press “STOP/CANCEL ” for 3 seconds, there will be a long “beep” denoting entering into the children-lock state; meanwhile, LED will display “”.

Turn Off Child Lock:: In locked state, press “ STOP/CANCEL ” for 3 seconds, there will be a long “beep” denoting that lock is released.

## 18. COOKING END REMINDER FEATURE

When the cooking is over, the buzzer will sound 5 “beep” to alert user the cooking is finished.

## 19. OTHER SPECIFICATIONS

- (1) In standby state , if the set digital clock displays current time, the icon “ : ” would flash; otherwise, it shows “0:00”.
- (2) In setting function state, LED displays corresponding setting.
- (3) In working or pause state, LED displays surplus cooking time.



# SET UP & USE

## COOKING TECHNIQUES

Your microwave makes cooking easier than conventional cooking, provided you keep these considerations in mind:

### STIRRING

Stir foods such as casseroles and vegetables while cooking to distribute heat evenly. Food at the outside of the dish absorbs more energy and heats more quickly, so stir from the outside to the center. The oven will turn off when you open the door to stir your food.

### ARRANGEMENT

Arrange unevenly shaped foods, such as chicken pieces or chops, with the thicker, meatier parts toward the outside of the turntable where they receive more microwave energy. To prevent overcooking, place delicate areas, such as asparagus tips, toward the center of the turntable.

### SHIELDING

Shield food with narrow strips of aluminium foil to prevent overcooking. Areas that need shielding include poultry wing-tips, the ends of poultry legs, and corners of square baking dishes. Use only small amounts of aluminium foil. Larger amounts can damage your oven.

### TURNING

Turn foods over midway through cooking to expose all parts to microwave energy. This is especially important with large foods such as roasts.

### STANDING

Foods cooked in the microwave build up internal heat and continue to cook for a few minutes after heating stops. Let foods stand to complete cooking, especially foods such as cakes and whole vegetables. Roasts need this time to complete cooking in the center without overcooking the outer areas. All liquids, such as soup or hot chocolate, should be shaken or stirred when cooking is complete. Let liquids stand a moment before serving. When heating baby food, stir well at removal and test the temperature before serving.

### ADDING MOISTURE

Microwave energy is attracted to water molecules. Food that is uneven in moisture content should be covered or allowed to stand so that the heat disperses evenly. Add a small amount of water to dry food to help it cook.

## CLEANING & CARE

1. When cleaning surfaces of door and front face of oven, use only mild, nonabrasive soaps, or detergents and apply with a sponge or soft cloth.
2. Turn off the oven and remove the power plug from the wall socket before cleaning.
3. Keep the inside of the oven clean. When food splatters or spilled liquids adhere to oven walls, wipe with a damp cloth. Mild detergent may be used if the oven gets very dirty. Avoid the use of spray and other harsh cleaners as they may stain, streak or dull the door surface.
4. The outside surfaces should be cleaned with a damp cloth. To prevent damage to the operating parts inside the oven, water should not be allowed to sweep into the ventilation openings.
5. Wipe the window on both sides with a damp cloth to remove any spills or splatters.
6. Do not allow the control panel to become wet. Clean with a soft, damp cloth. When cleaning the control panel, leave oven door open to prevent oven from accidentally turning on.
7. If steam accumulates inside or around the outside of the oven door, wipe with a soft cloth. This may occur when the microwave oven is operated under high humidity conditions, this is normal.
8. It is occasionally necessary to remove the glass tray for cleaning. Wash the tray in warm sudsy water or in a dishwasher.
9. The roller ring and oven floor should be cleaned regularly to avoid excessive noise. Simply wipe the bottom surface of the oven with mild detergent. The roller ring may be washed in mild sudsy water or dishwasher. When removing the roller ring from cavity floor for cleaning, be sure to replace in the proper position.
10. Remove odors from your oven by combining a cup of water with the juice and skin of one lemon in a deep bowl, microwave for 5 minutes. Wipe thoroughly and dry with a soft cloth.
11. When it becomes necessary to replace the oven light, please consult a dealer to have it replaced.
12. Please do not dispose this appliance into the domestic rubbish bin; it should be disposed to the particular disposal center provided by the municipalities.

# TROUBLESHOOTING & WARRANTY

## BEFORE YOU CALL FOR SERVICE

IF THE OVEN FAILS TO OPERATE:

- A) Check to make sure that the oven is plugged in securely. If it is not, remove the plug from the outlet, wait 10 seconds and plug it in again securely.
- B) Check for a blown circuit fuse or a tripped main circuit breaker. If these seem to be operating properly, test the outlet with another appliance.
- C) Check to make sure the control panel is programmed correctly and the timer is set.
- D) Check to ensure that the door is securely closed engaging the door safety lock system. Otherwise, the microwave energy will not flow into the oven.

IF NONE OF THE ABOVE SOLVES THE PROBLEM, CONTACT A QUALIFIED TECHNICIAN. DO NOT TRY TO ADJUST OR REPAIR THE OVEN YOURSELF.

## CUSTOMER SERVICE

# IMPORTANT

### **DO NOT RETURN THIS PRODUCT TO THE STORE**

If you have a problem with this product, please contact the W Appliance Co. Customer Satisfaction Center at 1-855-855-0294.

**DATED PROOF OF PURCHASE, MODEL # AND SERIAL #  
REQUIRED FOR WARRANTY SERVICE**

# TROUBLESHOOTING & WARRANTY

## TROUBLESHOOTING

Troubleshoot your problem by using the chart below. If the microwave oven still does not work properly, contact W Appliance Co. customer service center or the nearest authorized service center. Customers must never troubleshoot internal components. Microwaves hold dangerous voltage (5000V) even after power is removed. Only a certified technician should attempt Microwave repair.

TROUBLE	POSSIBLE CAUSE	POSSIBLE REMEDY
Oven will not start	A. Electrical cord for oven is not plugged in. B. Door is open. C. Wrong operation is set.	A. Plug into the outlet. B. Close the door and try again. C. Check instructions.
Arcing or sparking	A. Materials to be avoided in microwave oven, such as metal, were used. B. The oven is operated when empty. C. Spilled food remains in the cavity.	A. Use microwave-safe cookware only. B. Do not operate with oven empty. C. Clean cavity with wet towel.
Unevenly cooked foods	A. Materials to be avoided in microwave oven were used. B. Food is not defrosted completely. C. Cooking time, power level is not suitable. D. Food is not turned or stirred.	A. Use microwave-safe cookware only. B. Completely defrost food. C. Use correct cooking time, power level. D. Turn or stir food.
Overcooked foods	Cooking time, power level is not suitable.	Use correct cooking time and power level.
Under cooked foods	A. Materials to be avoided in microwave oven were used. B. Food is not defrosted completely. C. Oven ventilation ports are restricted. D. Cooking time, power level is not suitable.	A. Use microwave-safe cookware only. B. Completely defrost food. C. Check to see that oven ventilation ports are not restricted. D. Use correct cooking time and power level.
Improper defrosting	A. Materials to be avoided in microwave oven were used. B. Cooking time, power level is not suitable. C. Food is not turned or stirred.	A. Use microwave-safe cookware only. B. Use correct cooking time and power level. C. Turn or stir food.

# TROUBLESHOOTING & WARRANTY

## LIMITED WARRANTY

Commercial Chef brand is used under license. Any repair, replacement, or warranty service, and all questions about this product should be directed to W Appliance Co. at **1 (855) 855-0294** from the USA or Puerto Rico.

W Appliance Co. warrants to the original purchaser that the product will be free from defects in material, parts and workmanship for the period designated for this product. The warranty commences the day the product is purchased and covers up to a period of **1 year (12 months) for labor/1 year (12 months) for parts (manufacturing defects only)/5 years (60 months) magnetron tube for microwave (part only)**. W Appliance Co. agrees that it will, at its option, replace the defective product with either a new or remanufactured microwave equivalent to your original purchase during the warranty period. Should the Part warranty period exceed the Labor warranty period, W Appliance Co. will supply at no charge for the remainder of the Part warranty, any new or remanufactured replacement parts as required by the product. During this period all labor and service charges will become the responsibility of the customer.

**Exclusions:** This warranty does not apply to the below:

1. If the appearance or exterior of the product has been damaged or defaced, altered or modified in design or construction.
2. If the product original serial number has been altered or removed or cannot be readily determined.
3. If there is damage due to power line surge, user damage to the AC power cord or connection to improper voltage source.
4. If damage is due to general misuse, accidents or acts of God.
5. If repair attempts are done by unauthorized service agents, use of parts other than genuine parts or parts obtained from persons other than authorized service companies.
6. On units that have been transferred from the original owner.
7. On products that have been purchased as refurbished, like new, second-hand, in a "As-Is" or "Final Sale" terms.
8. To products used in a commercial or rental setting.
9. To products used in settings other than ordinary household use or used other than in accordance with the provided instructions.
10. To damages for service calls for improper installations.
11. To damages to decorative trims, finishes of the appliance or home incurred during installation.
12. To glass or replaceable light bulbs.
13. Transportation and shipping costs.
14. Labor after the initial 12 months.
15. Food loss for loss due to product failure or delay in service, repair or replacement.
16. To charges occurred for after hour service, weekend, holiday charges, tolls or mileage expense for service calls to remote areas.
17. Charges to make product available for service, such as removal of trim, shelves etc. that are not a part of the appliance.
18. Service calls to install or correct the installation of your microwave.
19. Service calls to instruct you how to use your microwave.
20. Service calls to repair or replace the house fuse, reset the circuit breaker or correct the wiring in the house.

REPAIR OR REPLACEMENT AS PROVIDED UNDER THIS WARRANTY IS THE EXCLUSIVE REMEDY OF THE CUSTOMER; W Appliance Co. SHALL NOT BE LIABLE FOR ANY INCIDENTAL OR CONSEQUENTIAL DAMAGES FOR BREACH OF ANY EXPRESS OR IMPLIED WARRANTY ON THIS PRODUCT, EXCEPT TO THE EXTENT PROHIBITED BY APPLICABLE LAW. ANY IMPLIED WARRANTY OF MERCHANTABILITY OF FITNESS FOR A PARTICULAR PURPOSE ON THIS PRODUCT IS LIMITED TO THE DURATION OF THE WARRANTY.

Some states do not allow the exclusion or limitations of incidental or consequential damages, or limitations on how long the warranty lasts. In these cases the above exclusions or limitations may not apply to you. This warranty gives you specific legal rights and you may also have other rights which vary from state to state.

**Obtaining Service:** To obtain service, product literature, supplies or accessories please call **1 (855) 855-0294** to create a ticket for exchange/repair. Please make sure to provide the date of purchase, model number and a brief description of the problem. Our customer service representative will contact you or send detailed return instructions. W Appliance Co. does not warrant that the appliance will work properly in all environmental conditions, and makes no warranty and representation, either implied or expressed, with respect to the quality, performance, merchantability, or fitness for a particular purpose other than the purpose identified within this user's manual. W Appliance Co. has made every effort to ensure that this user's manual is accurate and disclaims liability for any inaccuracies or omissions that may have occurred. Information in this user's manual is subject to change without notice and does not represent a commitment on the part of W Appliance Co. W Appliance Co. reserves the right to make improvements to this user's manual and/or to the products described in this user's manual at any time without notice. If you find information in this manual that is incorrect, misleading, or incomplete, please contact us at **1-855-855-0294**.

W Appliance Co.,  
1356 Broadway  
New York, NY 10018







© 2022 Commercial Chef is a W Appliance Company.  
All Rights Reserved.