

NV51K6650DS

30" Double Wall Oven

Features

- Guiding Light Controls
- Wi-Fi Connectivity
- Wi-Fi Enabled Temperature Probe
- LED Spotlights
- Easy View Window
- 6 Heavy Duty Racks including a Gliding Rack
- Broil Element
- Smart Control Key
- 6 Rack Positions
- Drop-Down Door Design
- Full Touch Control Method

Convenience

- Rapid Preheat
- Sabbath Mode
- Hybrid Clean and Self-Clean
- Hidden Bake Element
- Delay Start
- Convection Conversion
- Child Safety Lock
- Proofing
- Warming Mode
- Kitchen Timer



Steam Cook



Dual Convection

Available Colors



Stainless Steel (shown)



Black Stainless Steel

Signature Features

STEAM COOK

- Delivers moisture at precise times for a crisp and brown outside and tender inside.

DUAL CONVECTION

- Circulates air for faster, more even cooking using true convection.

5.1/5.1 CU. FT. CAPACITY

- Accommodates a roast, multiple casserole dishes or several racks of cookies.

NV51K6650DS

30" Double Wall Oven

Cabinet Dimensions

Double Oven Installed in Cabinet

*Junction Box

**Allow a minimum of 22" for clearance to adjacent corners, drawers, walls, etc. when door is open.

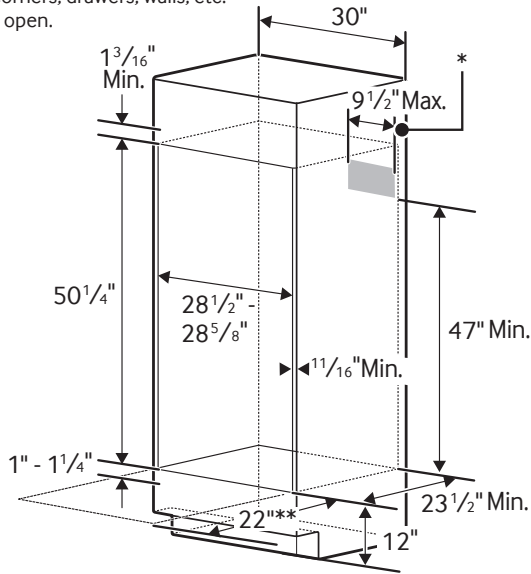

Product Dimensions

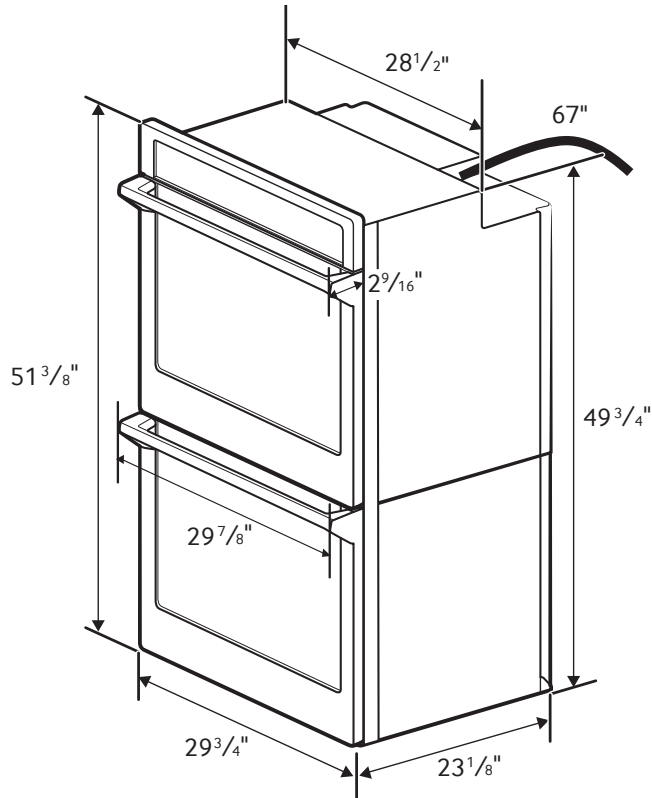

Total Capacity: 5.1/5.1 cu. ft.

Upper Oven: 5.1 cu. ft. total, 2.8/2.2 cu. ft.

Lower Oven: 5.1 cu. ft.

- Hidden Bake Element
- Bake: 175°F–550°F
- Convection Bake: 175°F–550°F
- Convection Roast: 175°F–550°F
- Broil: Low-High
- Steam Bake: 230°F–550°F
- Steam Roast: 230°F–550°F
- Proofing
- Sabbath Mode

Warranty

One (1) Year All Parts and Labor

Product Dimensions & Weight (WxHxD)

Outside (Max) Wall Oven Dimensions:

29⁷/₈" x 51³/₈" x 25¹¹/₁₆"

Wall Oven Cut-Out Dimensions:

28¹/₂" x 50¹/₄" x 23¹/₂"

Weight: 260.1 lbs.

Shipping Dimensions & Weight (WxHxD)

Dimensions:

33¹/₂" x 56³/₈" x 29¹³/₁₆"

Weight: 288.8 lbs.

Color

Model #

UPC Code

Stainless Steel

NV51K6650DS

887276184005

Black Stainless Steel

NV51K6650DG

887276183992

KW RATING	
240V	9.3 kW
208V	7.0 kW
BREAKER SIZE	
240V	40 Amps
208V	40 Amps

SAMSUNG

Actual color may vary. Design, specifications, and color availability are subject to change without notice. Non-metric weights and measurements are approximate.

©2018 Samsung Electronics America, Inc. 85 Challenger Road, Ridgefield Park, NJ 07660. Tel: 800-SAMSUNG. samsung.com. Samsung is a registered trademark of Samsung Electronics Co., Ltd.