

PLAYOFF 48" FOOSBALL TABLE ASSEMBLY INSTRUCTIONS



NG1031F













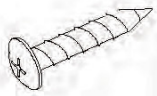
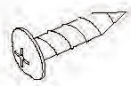
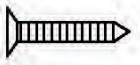

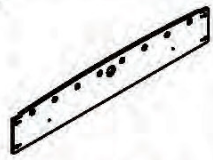
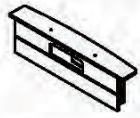
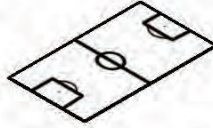



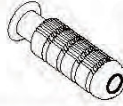

THANK YOU!

Thank you for purchasing this product.

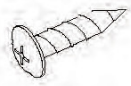
We work around the clock and around the globe to ensure that our products maintain the highest possible quality. However, in the rare instance that your product is defective or missing parts, contact your retailer, or call 800-759-0977, to submit parts requests or warranty claims. Please read the warranty information at the back of these assembly instructions for further details.

**IMPORTANT! PLEASE READ THESE ASSEMBLY INSTRUCTIONS
IN ENTIRETY BEFORE ASSEMBLING YOUR PRODUCT.**

PARTS IDENTIFIER (NOT TO SCALE)

<p>#1</p>  <p>BOLT 16 pcs</p>	<p>#2</p>  <p>FLAT WASHER 16 pcs</p>	<p>#3</p>  <p>1-1/2" SCREW 4 pcs</p>	<p>#4</p>  <p>1/2" SCREW 12 pcs</p>	<p>#5</p>  <p>1-1/2" FLAT SCREW 12 pcs</p>
<p>#6</p>  <p>HEX WRENCH 1 pc</p>	<p>#7</p>  <p>SIDE PANEL 2 pcs</p>	<p>#8</p>  <p>END PANEL 2 pcs</p>	<p>#9</p>  <p>PLAYFIELD 1 pc</p>	<p>#10</p>  <p>LEFT LEG 2 pcs</p>
<p>#11</p>  <p>RIGHT LEG 2 pcs</p>	<p>#12</p>  <p>LEG PANEL 2 pcs</p>	<p>#13</p>  <p>HAND GRIP 8 pcs</p>	<p>#14</p>  <p>BLUE PLAYER 13 pcs</p>	<p>#15</p>  <p>GREEN PLAYER 13 pcs</p>
<p>#16</p>  <p>2 PLAYER ROD 2 pcs</p>	<p>#17</p>  <p>3 PLAYER ROD 4 pcs</p>	<p>#18</p>  <p>5 PLAYER ROD 2 pcs</p>	<p>#19</p>  <p>3/4" SCREW 26 pcs</p>	<p>#20</p>  <p>FOAM BUMPER 16 pcs</p>
<p>#21</p>  <p>PLASTIC ROD WASHER 16 pcs</p>	<p>#22</p>  <p>ROD END CAP 8 pcs</p>	<p>#23</p>  <p>PLAYFIELD SUPPORT BRACE 2 pcs</p>	<p>#24</p>  <p>MANUAL SCORER 2 pcs</p>	<p>#25</p>  <p>SOCCER BALL 2 pcs</p>

ADDITIONAL EQUIPMENT
REQUIRED:

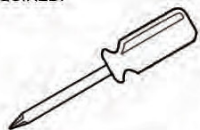

**PHILLIPS HEAD
SCREWDRIVER**

ASSEMBLY TIPS

1. Find a clean, level surface to begin the assembly of your game table. The table will be partially assembled upside down and then turned over onto its legs. This is a heavy game and turning it over will require at least two strong adults.
2. Remove all of the contents from box and verify that you have all of the parts shown on the Parts Identifier before you begin assembly. **Note: Some parts may be pre-installed or pre-assembled.**
3. Some figures or drawings may not look exactly like your product. Please read and understand the text before beginning each assembly step.
4. **When installing parts that have more than one screw or bolt, hand tighten all screws or bolts in place before finishing tightening with screwdriver or hex wrench.**
5. Electric screwdrivers may be helpful during assembly; however, please set a low torque and use extreme caution because screws may be stripped or overtightened if the electric screwdriver's torque is set too high.

WARNINGS!

READ AND FOLLOW ALL ASSEMBLY, OPERATION AND SAFETY INSTRUCTIONS CAREFULLY.

CHOKER HAZARD - THIS TABLE CONTAINS SMALL BALLS AND PARTS - NOT SUITABLE FOR CHILDREN UNDER 3 YEARS OF AGE.

ASSEMBLY INSTRUCTIONS

1. Insert pre-assembled BLUE PLAYER RODS and GREEN PLAYER RODS into one SIDE PANEL #7 as shown below. *Note: Although this table is assembled upside down, players are shown upright for clarity. Each team should face the opposite goal when table is turned over. Ensure that FOAM BUMPERS and PLASTIC ROD WASHERS are in place before inserting rods.*

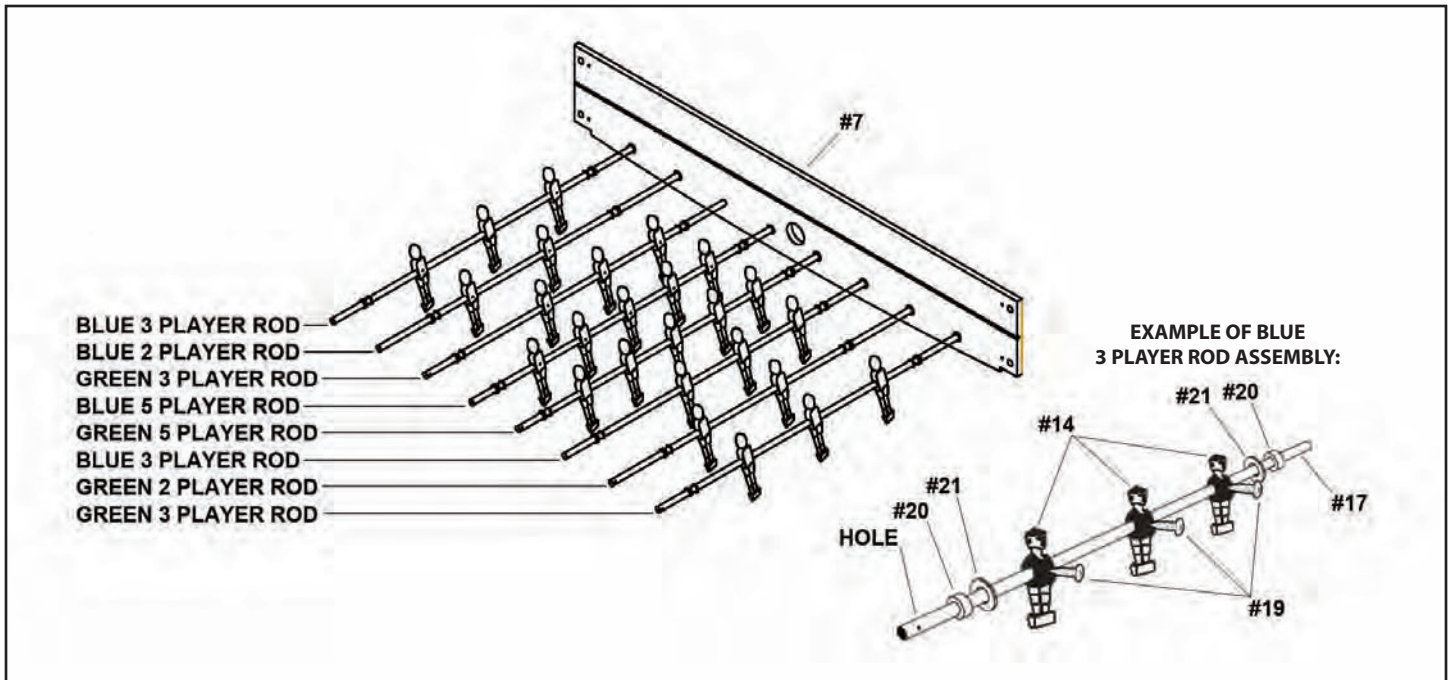

2. Insert PLAYER RODS into remaining SIDE PANEL #7.

3. Attach one END PANEL #8 to one end of the table with 1-1/2" FLAT SCREW #5.

4. Slide PLAYFIELD #9 with field markings facing down into the SIDE PANEL grooves.

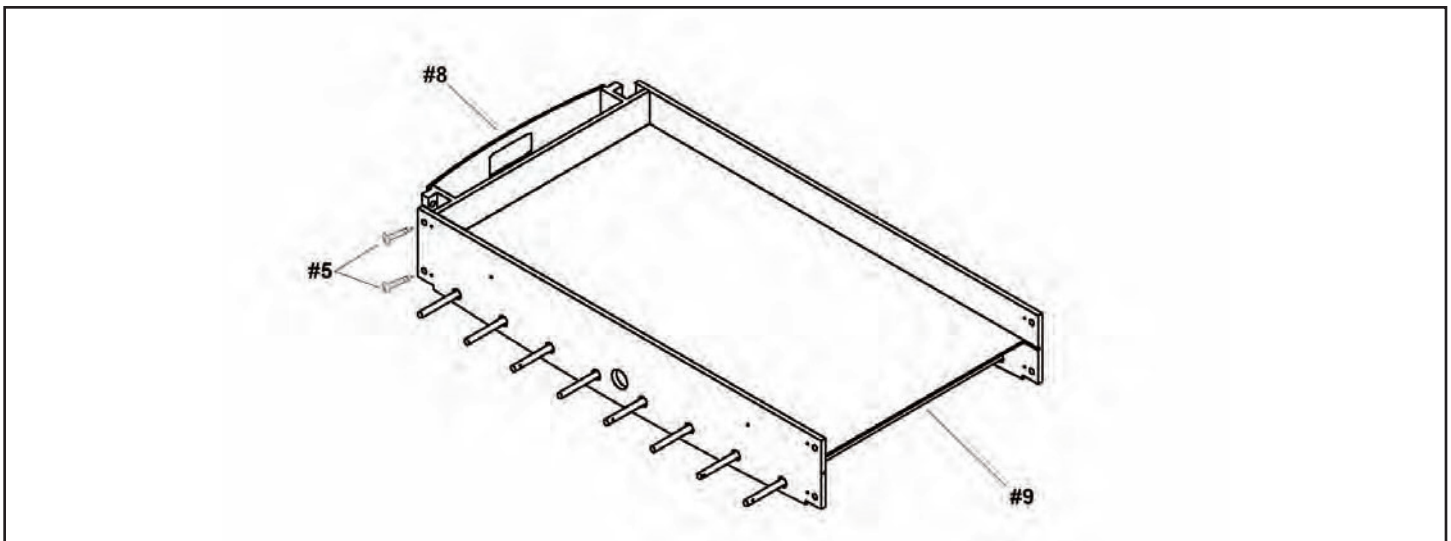

ASSEMBLY INSTRUCTIONS

5. Attach remaining END PANEL #8 to the opposite end of the table with 1-1/2" FLAT SCREW #5.

6. Attach each PLAYFIELD SUPPORT BRACE #23 across the underside of the PLAYFIELD by fastening to the SIDE PANELS with 1-1/2" SCREW #3.

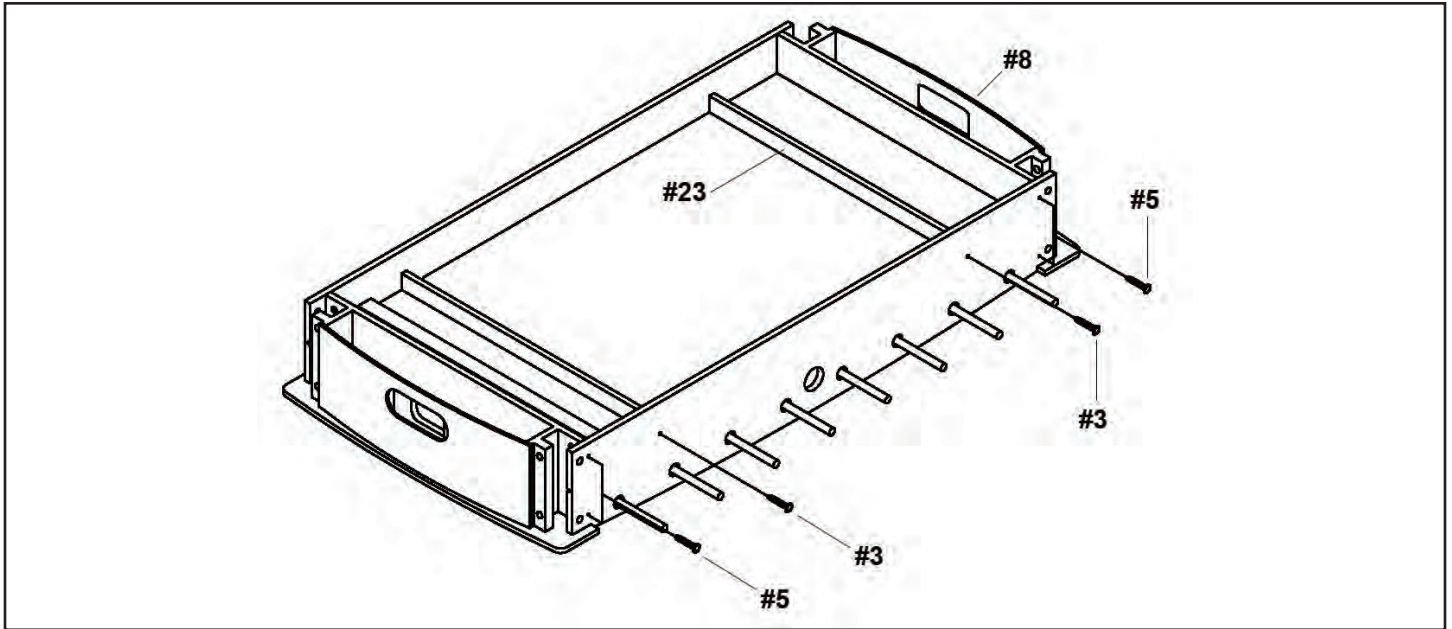

7. Attach LEFT LEGS #10 and RIGHT LEGS #11 to the corners of the table as shown below using BOLT #1 and FLAT WASHER #2.

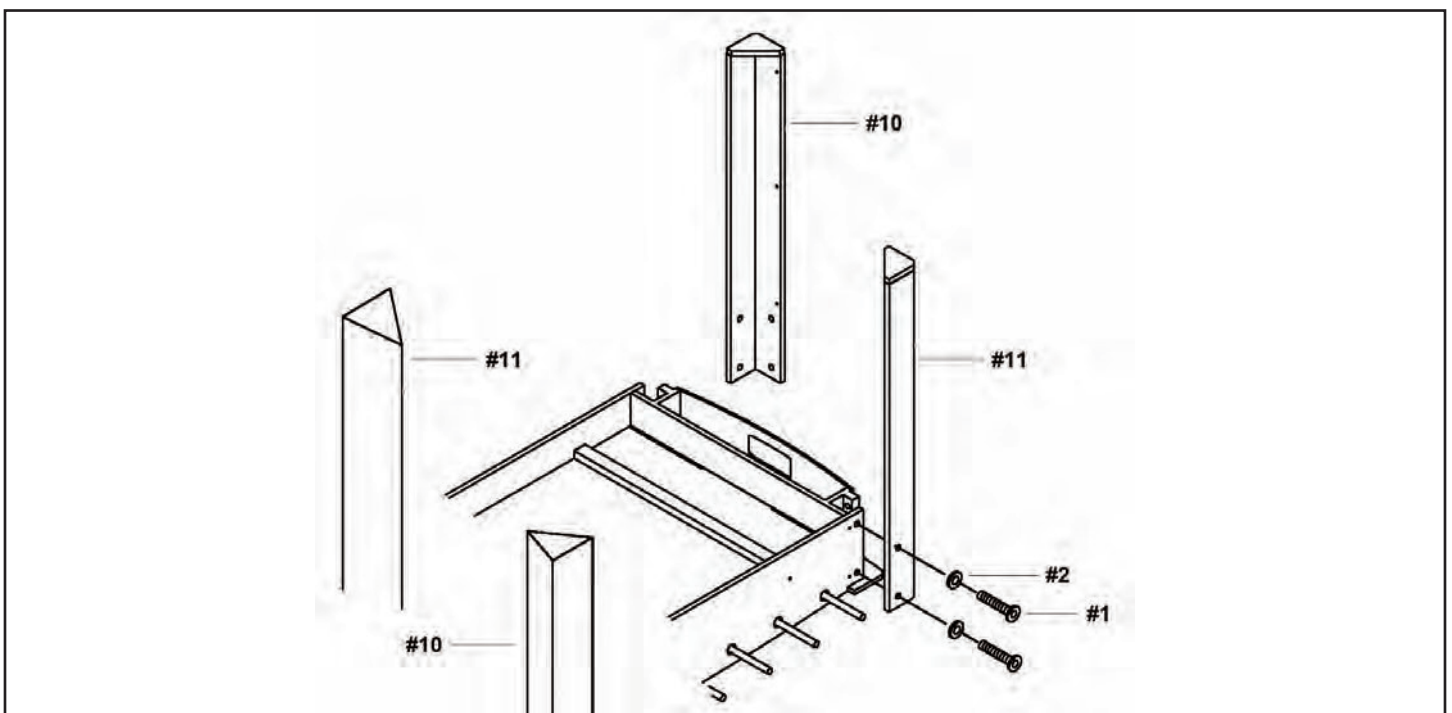

ASSEMBLY INSTRUCTIONS

8. Attach each LEG PANEL #12 to LEGS with 1/2" SCREW #4. *Note: Graphics should face outward.* Carefully turn table over.

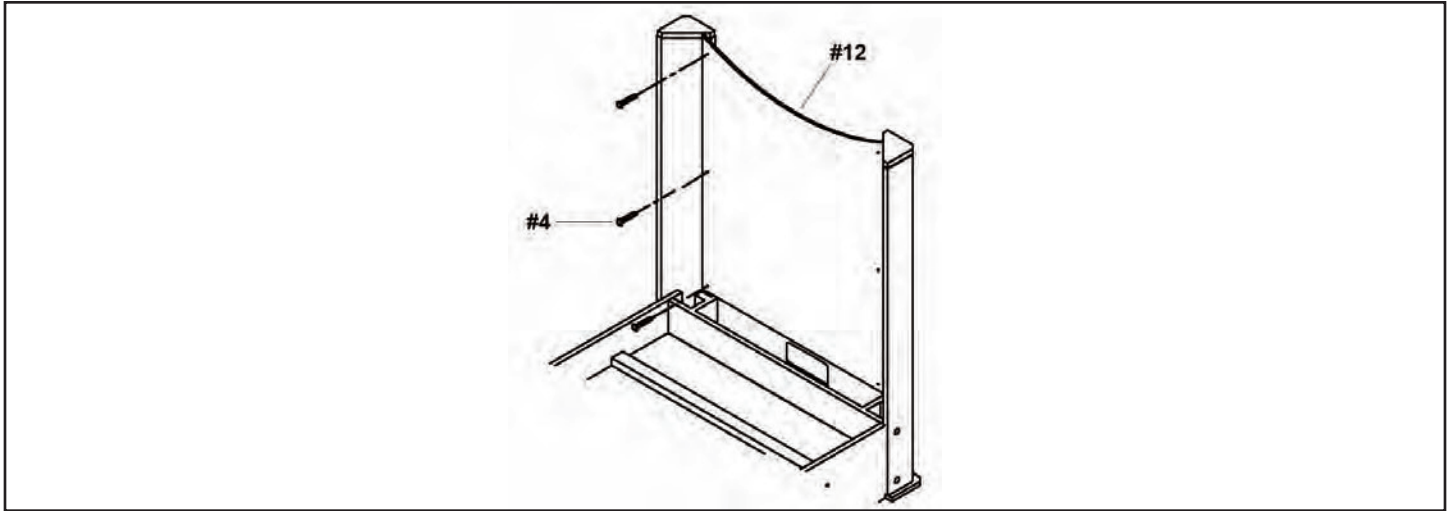

9. Attach HAND GRIP #13 to the marked end of each PLAYER ROD. Attach ROD END CAP #22 to the opposite end of PLAYER RODS.

10. Attach one MANUAL SCORER #24 to each end of the table with 1-1/2" FLAT SCREW #5.

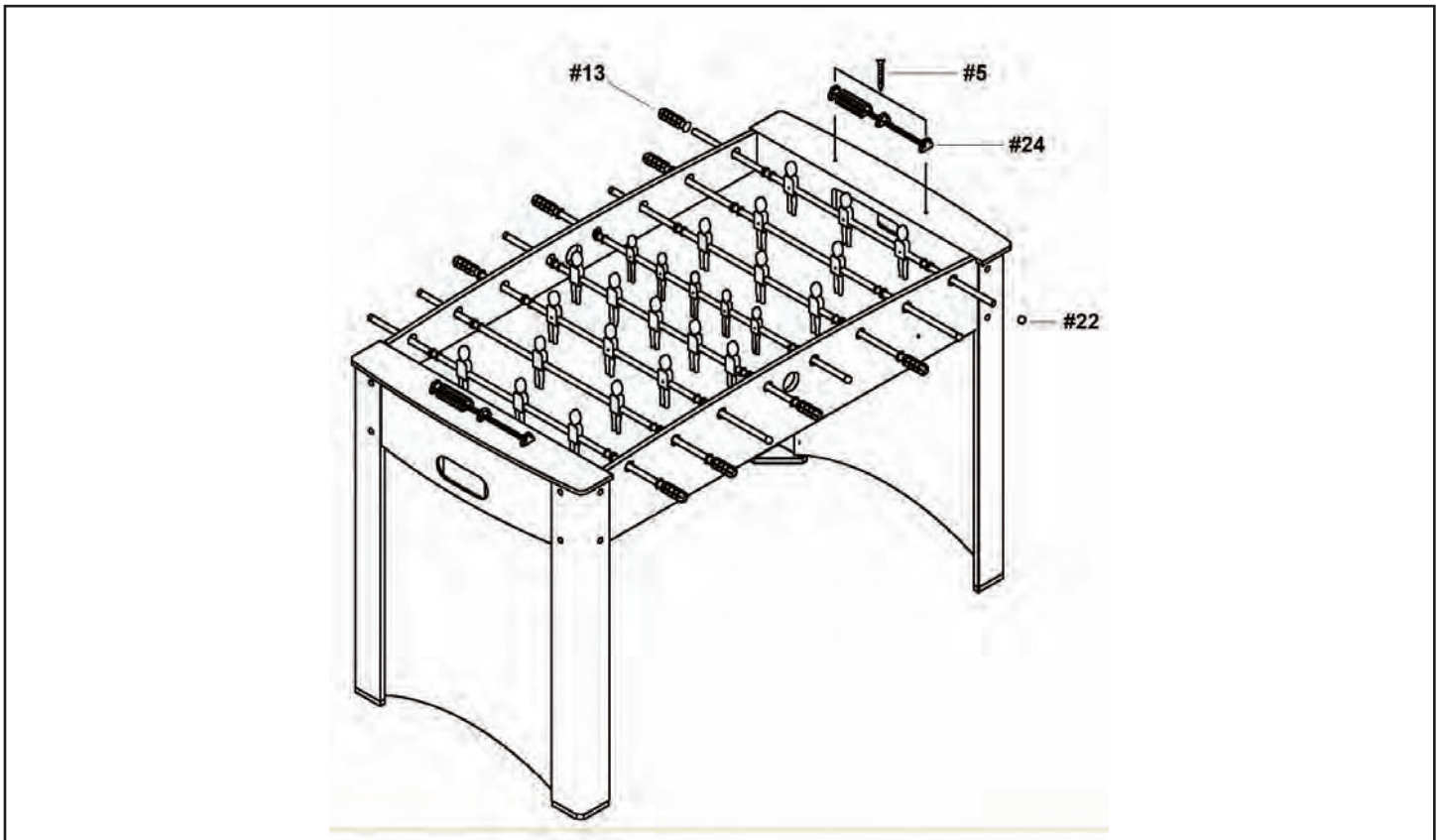

CONGRATULATIONS!

You have now assembled your Game Table.
Please note the Care and Use instructions below to ensure years of trouble free use of your game table.

CARE AND USE

1. This product is intended for INDOOR use only.
2. Do NOT sit, climb or lean on the table.
3. Do NOT drag the table when moving it as this will damage the legs.

180-DAY LIMITED WARRANTY

This product is warranted to the original purchaser to be free from defects in material or workmanship for a period of 180 days from the date of the original retail purchase.

This warranty does not cover defects or damage due to improper installation, alteration, accident or any other event beyond the control of the manufacturer. Defects or damage resulting from misuse, abuse or negligence will void this warranty. This warranty does not cover scratching or damage that may result from normal usage.

This product is not intended for institutional or commercial use; the manufacturer does not assume any liability for such use. Institutional or commercial use will void this warranty.

This warranty is nontransferable and is expressly limited to the repair or replacement of the defective product. During the warranty period, the manufacturer shall repair or replace defective parts at no cost to the purchaser. Shipping charges and insurance are not covered and are the responsibility of the purchaser. Labor charges and related expenses for removal, installation or replacement of the product or components are not covered under this warranty.

The manufacturer reserves the right to make substitutions to warranty claims if parts are unavailable or obsolete.

The manufacturer shall not be liable for loss of use of the product or other consequential or incidental costs, expenses or damages incurred by the consumer of any other use. The user assumes all risk of injury resulting from the use of this product.

This warranty is expressly in lieu of all other warranties, expressed or implied, including warranties of merchantability or fitness for use to the extent permitted by Federal or state law. Neither the manufacturer nor any of its representatives assumes any other liability in connection with this product.

All warranty claims must be made through the retailer where the product was originally purchased. A purchase receipt or other proof of date of purchase will be required to process all warranty claims. The model number and part numbers found within the assembly instructions will be required when submitting any parts requests or warranty claims.







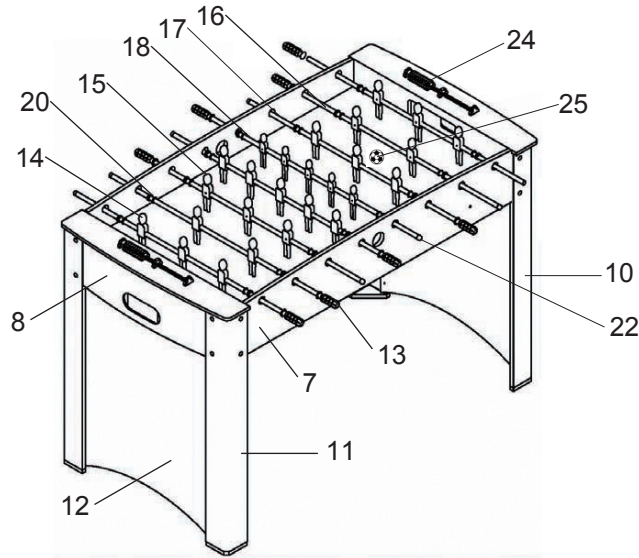



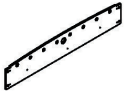

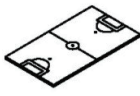



For further warranty information or inquiries, please call 800-759-0977

SOCCER TABLE - NG1031F







Parts List

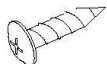

PARTS

#7 NGP5501  SIDE PANEL	#8 NGP5502  END PANEL	#9 NGP5503  PLAYFIELD	#10 NGP5504  LEFT LEG	#11 NGP5505  RIGHT LEG	#12 NGP5506  LEG PANEL	#13 NGP5507  HAND GRIP
#14 NGP5508  BLUE PLAYER	#15 NGP5509  GREEN PLAYER	#16 NGP5510  2 PLAYER ROD	#17 NGP5511  3 PLAYER ROD	#18 NGP5512  5 PLAYER ROD	#20 NGP5513  FOAM BUMPER	#22 NGP5514  ROD END CAP
#23 NGP5515  SUPPORT BRACE	#24 NGP5516  MANUAL SCORER	#25 NG5102  SOCCER BALL				

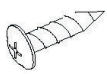
HARDWARE PACK - NGP5500

#1  BOLT	#2  FLAT WASHER	#3  1-1/2" SCREW	#4  1/2" SCREW	#5  1-1/2" FLAT SCREW	#6  HEX WRENCH	#19  3/4" SCREW
#21  PLASTIC ROD WASHER	ADDITIONAL EQUIPMENT REQUIRED:  PHILLIPS HEAD SCREWDRIVER					